

SiT8208

Ultra Performance Oscillator



Features

- Any frequency between 1 and 80 MHz accurate to 6 decimal places
- 100% pin-to-pin drop-in replacement to quartz-based oscillators
- Ultra low phase jitter: 0.5 ps (12 kHz to 20 MHz)
- Frequency stability as low as ± 10 PPM
- Industrial or extended commercial temperature range
- LVC MOS/LVTTL compatible output
- Standard 4-pin packages: 2.5 x 2.0, 3.2 x 2.5, 5.0 x 3.2, 7.0 x 5.0 mm x mm
- Instant samples with [Time Machine II](#) and [field programmable oscillators](#)
- Outstanding silicon reliability of 2 FIT or 500 million hour MTBF
- Pb-free, RoHS and REACH compliant
- Ultra short lead time

Applications

- SATA, SAS, Ethernet, PCI Express, video, WiFi
- Computing, storage, networking, telecom, industrial control



Electrical Characteristics^[1]

Parameter	Symbol	Min.	Typ.	Max.	Unit	Condition
Frequency Range						
Output Frequency Range	f	1	–	80	MHz	
Frequency Stability and Aging						
Frequency Stability	F_stab	-10	–	+10	PPM	Inclusive of Initial tolerance at 25 °C, and variations over operating temperature, rated power supply voltage and load
		-20	–	+20	PPM	
		-25	–	+25	PPM	
		-50	–	+50	PPM	
First year Aging	F_aging	-1.5	–	+1.5	PPM	25°C
10-year Aging		-5	–	+5	PPM	25°C
Operating Temperature Range						
Operating Temperature Range	T_use	-20	–	+70	°C	Extended Commercial
		-40	–	+85	°C	Industrial
Supply Voltage and Current Consumption						
Supply Voltage	Vdd	1.71	1.8	1.89	V	Supply voltages between 2.5V and 3.3V can be supported. Contact SiTime for additional information.
		2.25	2.5	2.75	V	
		2.52	2.8	3.08	V	
		2.97	3.3	3.63	V	
Current Consumption	Idd	–	31	33	mA	No load condition, f = 20 MHz, Vdd = 2.5V, 2.8V or 3.3V
		–	29	31	mA	No load condition, f = 20 MHz, Vdd = 1.8V
OE Disable Current	I_OD	–	–	31	mA	Vdd = 2.5V, 2.8V or 3.3V, OE = GND, output is Weakly Pulled Down
		–	–	30	mA	Vdd = 1.8 V. OE = GND, output is Weakly Pulled Down
Standby Current	I_std	–	–	70	μA	Vdd = 2.5V, 2.8V or 3.3V, \overline{ST} = GND, output is Weakly Pulled Down
		–	–	10	μA	Vdd = 1.8 V. \overline{ST} = GND, output is Weakly Pulled Down
LVC MOS Output Characteristics						
Duty Cycle	DC	45	–	55	%	
Rise/Fall Time	Tr, Tf	–	1.2	2	ns	15 pF load, 10% - 90% Vdd
Output Voltage High	VOH	90%	–	–	Vdd	IOH = -6 mA, IOL = 6 mA, (Vdd = 3.3V, 2.8V, 2.5V)
Output Voltage Low	VOL	–	–	10%	Vdd	IOH = -3 mA, IOL = 3 mA, (Vdd = 1.8V)
Input Characteristics						
Input Voltage High	VIH	70%	–	–	Vdd	Pin 1, OE or \overline{ST}
Input Voltage Low	VIL	–	–	30%	Vdd	Pin 1, OE or \overline{ST}
Input Pull-up Impedance	Z_in	–	100	250	kΩ	Pin 1, OE logic high or logic low, or \overline{ST} logic high
		2	–	–	MΩ	Pin 1, \overline{ST} logic low

Note:

1. All electrical specifications in the above table are specified with 15 pF output load and for all Vdd(s) unless otherwise stated.

Electrical Characteristics^[1] (Continued)

Parameter	Symbol	Min.	Typ.	Max.	Unit	Condition
Startup and Resume Timing						
Startup Time	T_start	–	7	10	ms	Measured from the time Vdd reaches its rated minimum value
OE Enable/Disable Time	T_oe	–	–	150	ns	f = 80 MHz, For other frequencies, T_oe = 100 ns + 3 cycles
Resume Time	T_resume	–	6	10	ms	In standby mode, measured from the time \overline{ST} pin crosses 50% threshold. Refer to Figure 5.
Jitter						
RMS Period Jitter	T_jitt	–	1.5	2	ps	
		–	2	3	ps	f = 75 MHz, Vdd = 1.8V
RMS Phase Jitter (random)	T_phj	–	0.5	1	ps	f = 10 MHz, Integration bandwidth = 12 kHz to 20 MHz

Note:

1. All electrical specifications in the above table are specified with 15 pF output load and for all Vdd(s) unless otherwise stated.

Pin Configuration

Pin	Symbol	Functionality	
1	OE/ \overline{ST}	Output Enable	H or Open ^[2] : specified frequency output L: output is high impedance. Only output driver is disabled.
		Standby	H or Open ^[2] : specified frequency output L: output is low (weak pull down). Device goes to sleep mode. Supply current reduces to I_std.
2	GND	Power	Electrical ground ^[3]
3	OUT	Output	Oscillator output
4	VDD	Power	Power supply voltage ^[3]

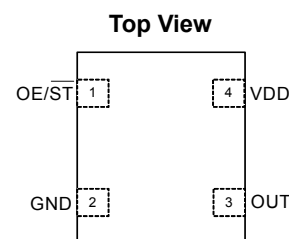

Notes:

2. A pull-up resistor of <10 k Ω between OE/ \overline{ST} pin and Vdd is recommended in high noise environment.
3. A capacitor of value 0.1 μ F between Vdd and GND is recommended.

Absolute Maximum

Attempted operation outside the absolute maximum ratings of the part may cause permanent damage to the part. Actual performance of the IC is only guaranteed within the operational specifications, not at absolute maximum ratings.

Parameter	Min.	Max.	Unit
Storage Temperature	-65	150	°C
VDD	-0.5	4	V
Electrostatic Discharge	–	2000	V
Soldering Temperature (follow standard Pb free soldering guidelines)	–	260	°C
Junction Temperature	–	150	°C

Thermal Consideration

Package	θ JA, 4 Layer Board (°C/W)	θ JA, 2 Layer Board (°C/W)	θ JC, Bottom (°C/W)
7050	191	263	30
5032	97	199	24
3225	109	212	27
2520	117	222	26

Environmental Compliance

Parameter	Condition/Test Method
Mechanical Shock	MIL-STD-883F, Method 2002
Mechanical Vibration	MIL-STD-883F, Method 2007
Temperature Cycle	JESD22, Method A104
Solderability	MIL-STD-883F, Method 2003
Moisture Sensitivity Level	MSL1 @ 260°C

Phase Noise Plot

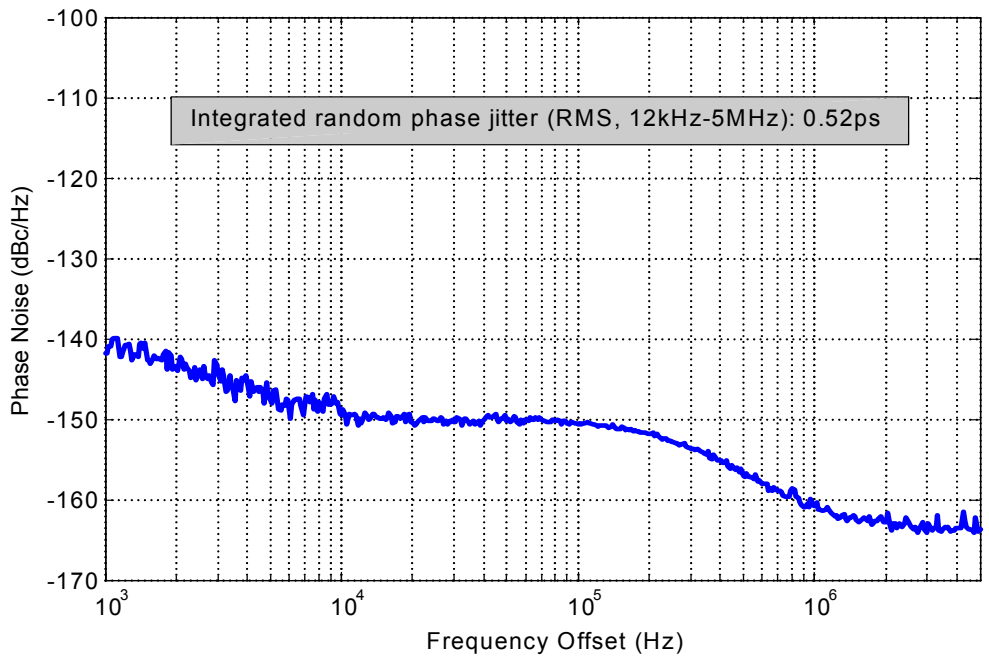

Figure 1. Phase Noise, 10 MHz, 3.3V, LVCMOS Output

Test Circuit and Waveform

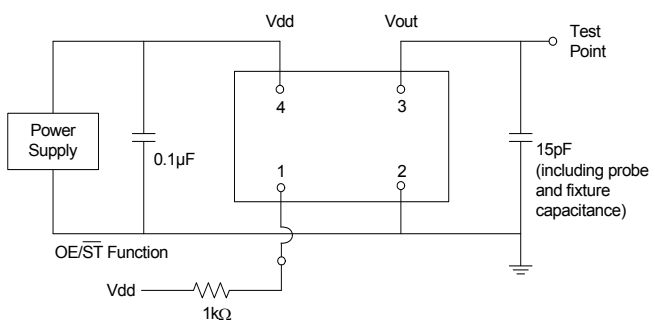

Figure 2. Test Circuit

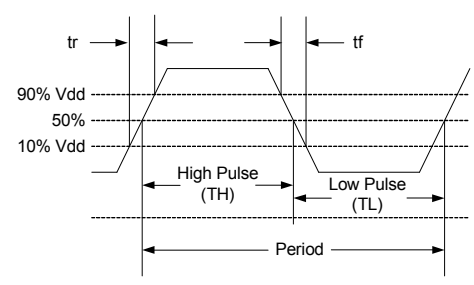

Figure 3. Waveform

Notes:

- 4. Duty Cycle is computed as Duty Cycle = TH/Period.
- 5. SiT8208 supports the configurable duty cycle feature. For custom duty cycle at any given frequency, contact [SiTime](http://www.sitime.com).

Timing Diagram

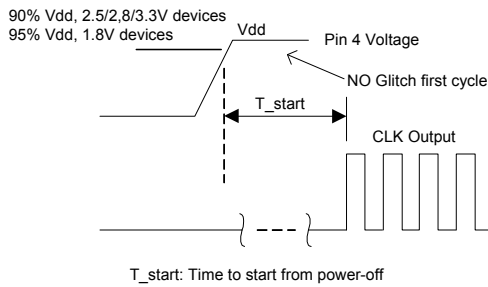

Figure 4. Startup Timing (OE/ST Mode)

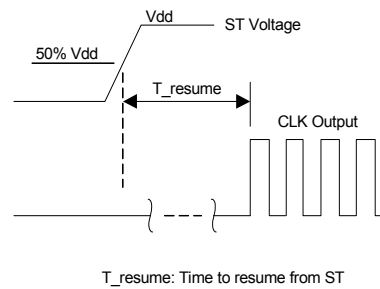

Figure 5. Standby Resume Timing (ST Mode Only)

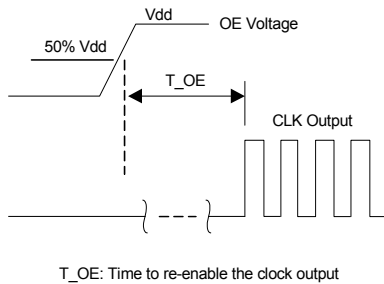

Figure 6. OE Enable Timing (OE Mode Only)

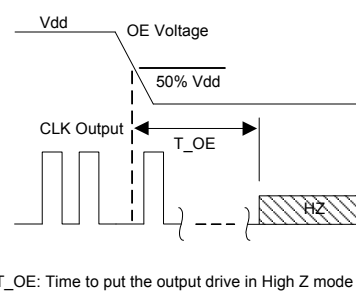

Figure 7. OE Disable Timing (OE Mode Only)

Notes:

- 6. SiT8208 supports NO RUNT pulses and No glitches during startup or resume.
- 7. SiT8208 supports gated output which is accurate within rated frequency stability from the first cycle.

Performance Plots

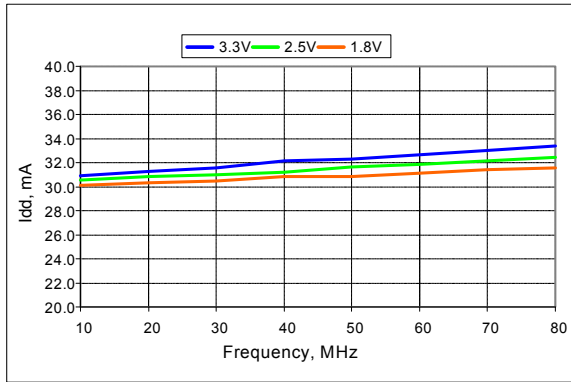

Figure 8. Idd vs Frequency

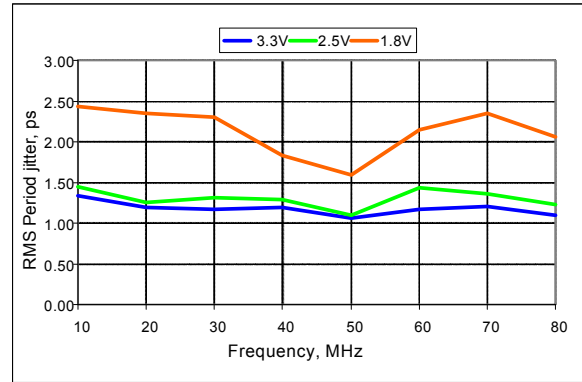

Figure 9. RMS Period Jitter vs Frequency

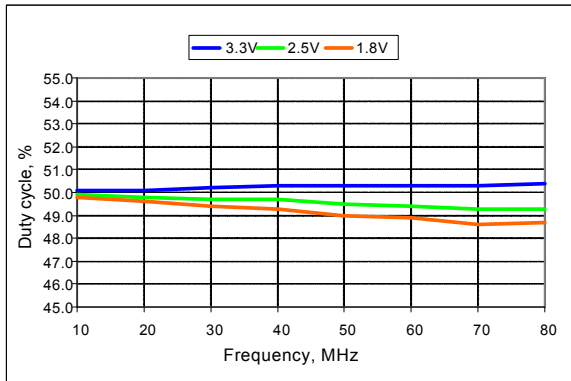

Figure 10. Duty Cycle vs Frequency

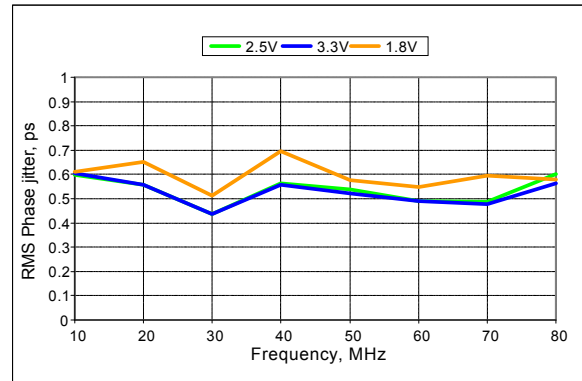

Figure 11. RMS Phase Jitter vs Frequency

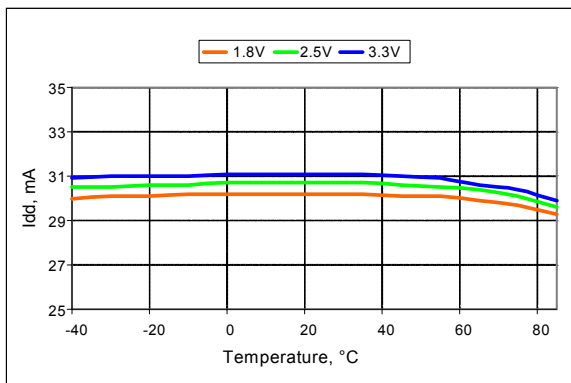

Figure 12. Idd vs Temperature, 10 MHz Output

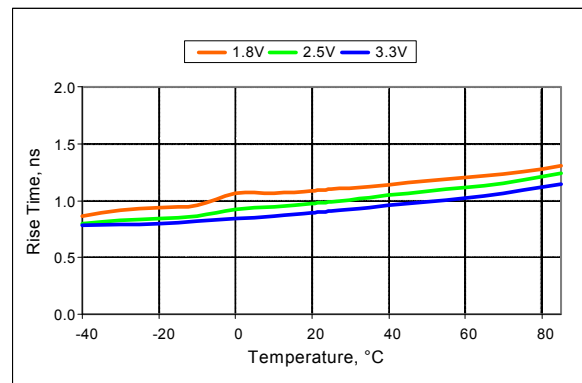

Figure 13. Rise Time vs Temperature, 75 MHz Output

Note:

8. All plots are measured with 15 pF load at room temperature, unless otherwise stated.

Programmable Drive Strength

The SiT8208 includes a programmable drive strength feature to provide a simple, flexible tool to optimize the clock rise/fall time for specific applications. Benefits from the programmable drive strength feature are:

- Improves system radiated electromagnetic interference (EMI) by slowing down the clock rise/fall time
- Improves the downstream clock receiver's (RX) jitter by decreasing (speeding up) the clock rise/fall time.
- Ability to drive large capacitive loads while maintaining full swing with sharp edge rates.

For more detailed information about rise/fall time control and drive strength selection, see the SiTime Applications Note section; <http://www.sitime.com/support/application-notes>.

EMI Reduction by Slowing Rise/Fall Time

Figure 14 shows the harmonic power reduction as the rise/fall times are increased (slowed down). The rise/fall times are expressed as a ratio of the clock period. For the ratio of 0.05, the signal is very close to a square wave. For the ratio of 0.45, the rise/fall times are very close to near-triangular waveform. These results, for example, show that the 11th clock harmonic can be reduced by 35 dB if the rise/fall edge is increased from 5% of the period to 45% of the period.

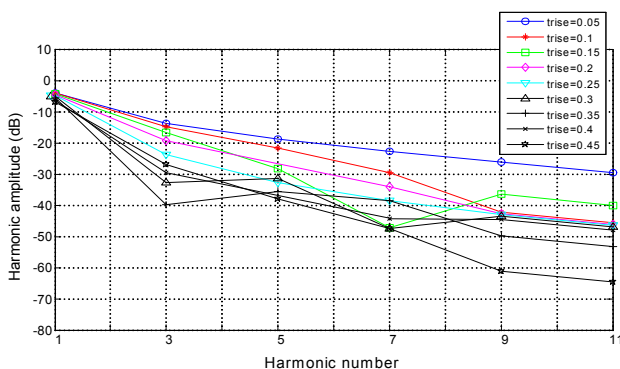

Figure 14. Harmonic EMI reduction as a Function of Slower Rise/Fall Time

Jitter Reduction with Faster Rise/Fall Time

Power supply noise can be a source of jitter for the downstream chipset. One way to reduce this jitter is to increase rise/fall time (edge rate) of the input clock. Some chipsets would require faster rise/fall time in order to reduce their sensitivity to this type of jitter. The SiT8208 provides up to 3 additional high drive strength settings for very fast rise/fall time. Refer to the Rise/Fall Time Tables to determine the proper drive strength.

High Output Load Capability

The rise/fall time of the input clock varies as a function of the actual capacitive load the clock drives. At any given drive strength, the rise/fall time becomes slower as the output load increases. As an example, for a 3.3V SiT8208 device with default drive strength setting, the typical rise/fall time is 1.15ns for 15 pF output load. The typical rise/fall time slows down to 2.72ns when the output load increases to 45 pF. One can

choose to speed up the rise/fall time to 1.41ns by then increasing the drive strength setting on the SiT8208.

The SiT8208 can support up to 60 pF or higher in maximum capacitive loads with up to 3 additional drive strength settings. Refer to the Rise/Fall Time Tables to determine the proper drive strength for the desired combination of output load vs. rise/fall time

SiT8208 Drive Strength Selection

Tables 1 through 5 define the rise/fall time for a given capacitive load and supply voltage.

1. Select the table that matches the SiT8208 nominal supply voltage (1.8V, 2.5V, 2.8V, 3.0V, 3.3V).
2. Select the capacitive load column that matches the application requirement (5 pF to 60 pF)
3. Under the capacitive load column, select the desired rise/fall times.
4. The left-most column represents the part number code for the corresponding drive strength.
5. Add the drive strength code to the part number for ordering purposes.

Calculating Maximum Frequency

Based on the rise and fall time data given in Tables 1 through 4, the maximum frequency the oscillator can operate with guaranteed full swing of the output voltage over temperature as follows:

$$\text{Max Frequency} = \frac{1}{6 \times (\text{Trise})}$$

Example 1

Calculate f_{MAX} for the following condition:

- Vdd = 1.8V (Table 1)
- Capacitive Load: 30 pF
- Desired Tr/f time = 3 ns (rise/fall time part number code = G)

Part number for the above example:

SiT8208AIGG2-18E-55.500000



Drive strength code is inserted here. Default setting is “-”

Rise/Fall Time (10% to 90%) vs C_{LOAD} Tables

Rise/Fall Time Typ (ns)					
Drive Strength \ C _{LOAD}	5 pF	15 pF	30 pF	45 pF	60 pF
L	12.45	17.68	19.48	46.21	57.82
A	6.50	10.27	16.21	23.92	30.73
R	4.38	7.05	11.61	16.17	20.83
B	3.27	5.30	8.89	12.18	15.75
S	2.62	4.25	7.20	9.81	12.65
D	2.19	3.52	6.00	8.31	10.59
T	1.76	3.01	5.14	7.10	9.15
E	1.59	2.59	4.49	6.25	7.98
U	1.49	2.28	3.96	5.55	7.15
F	1.22	2.10	3.57	5.00	6.46
W	1.07	1.88	3.23	4.50	5.87
G	1.01	1.64	2.95	4.12	5.40
X	0.96	1.50	2.74	3.80	4.98
K	0.92	1.41	2.56	3.52	4.64
Y	0.88	1.34	2.39	3.25	4.32
Q	0.86	1.29	2.24	3.04	4.06
Z or "-": Default	0.82	1.24	2.07	2.89	3.82
M	0.77	1.20	1.94	2.72	3.61
N	0.66	1.15	1.84	2.58	3.41
P	0.51	1.09	1.76	2.45	3.24

Table 1. V_{DD} = 1.8V Rise/Fall Times for Specific C_{LOAD}

Rise/Fall Time Typ (ns)					
Drive Strength \ C _{LOAD}	5 pF	15 pF	30 pF	45 pF	60 pF
L	8.68	13.59	18.36	32.70	42.06
A	4.42	7.18	11.93	16.60	21.38
R	2.93	4.78	8.15	11.19	14.59
B	2.21	3.57	6.19	8.55	11.04
S	1.67	2.87	4.94	6.85	8.80
D	1.50	2.33	4.11	5.68	7.33
T	1.06	2.04	3.50	4.84	6.26
E	0.98	1.69	3.03	4.20	5.51
U	0.93	1.48	2.69	3.73	4.92
F	0.90	1.37	2.44	3.34	4.42
W	0.87	1.29	2.21	3.04	4.02
G or "-": Default	0.67	1.20	2.00	2.79	3.69
X	0.44	1.10	1.86	2.56	3.43
K	0.38	0.99	1.76	2.37	3.18
Y	0.36	0.83	1.66	2.20	2.98
Q	0.34	0.71	1.58	2.07	2.80
Z	0.33	0.65	1.51	1.95	2.65
M	0.32	0.62	1.44	1.85	2.50
N	0.31	0.59	1.37	1.77	2.39
P	0.30	0.57	1.29	1.70	2.28

Table 2. V_{DD} = 2.5V Rise/Fall Times for Specific C_{LOAD}

Rise/Fall Time Typ (ns)					
Drive Strength \ C _{LOAD}	5 pF	15 pF	30 pF	45 pF	60 pF
L	7.93	12.69	17.94	30.10	38.89
A	4.06	6.66	11.04	15.31	19.80
R	2.68	4.40	7.53	10.29	13.37
B	2.00	3.25	5.66	7.84	10.11
S	1.59	2.57	4.54	6.27	8.07
D	1.19	2.14	3.76	5.21	6.72
T	1.00	1.79	3.20	4.43	5.77
E	0.94	1.51	2.78	3.84	5.06
U	0.90	1.38	2.48	3.40	4.50
F	0.87	1.29	2.21	3.03	4.05
W	0.62	1.19	1.99	2.76	3.68
G or "-": Default	0.41	1.08	1.84	2.52	3.36
X	0.37	0.96	1.72	2.33	3.15
K	0.35	0.78	1.63	2.15	2.92
Y	0.33	0.67	1.54	2.00	2.75
Q	0.32	0.63	1.46	1.89	2.57
Z	0.31	0.60	1.39	1.80	2.43
M	0.30	0.57	1.31	1.72	2.30
N	0.30	0.56	1.22	1.63	2.22
P	0.29	0.54	1.13	1.55	2.13

Table 3. V_{DD} = 2.8V Rise/Fall Times for Specific C_{LOAD}

Rise/Fall Time Typ (ns)					
Drive Strength \ C _{LOAD}	5 pF	15 pF	30 pF	45 pF	60 pF
L	7.18	11.59	17.24	27.57	35.57
A	3.61	6.02	10.19	13.98	18.10
R	2.31	3.95	6.88	9.42	12.24
B	1.65	2.92	5.12	7.10	9.17
S	1.43	2.26	4.09	5.66	7.34
D	1.01	1.91	3.38	4.69	6.14
T	0.94	1.51	2.86	3.97	5.25
E	0.90	1.36	2.50	3.46	4.58
U	0.86	1.25	2.21	3.03	4.07
F or "-": Default	0.48	1.15	1.95	2.72	3.65
W	0.38	1.04	1.77	2.47	3.31
G	0.36	0.87	1.66	2.23	3.03
X	0.34	0.70	1.56	2.04	2.80
K	0.33	0.63	1.48	1.89	2.61
Y	0.32	0.60	1.40	1.79	2.43
Q	0.32	0.58	1.31	1.69	2.28
Z	0.30	0.56	1.22	1.62	2.17
M	0.30	0.55	1.12	1.54	2.07
N	0.30	0.54	1.02	1.47	1.97
P	0.29	0.52	0.95	1.41	1.90

Table 4. V_{DD} = 3.3V Rise/Fall Times for Specific C_{LOAD}

Instant Samples with Time Machine and Field Programmable Oscillators

SiTime supports a field programmable version of the SiT8208 low power oscillator for fast prototyping and real time customization of features. The [field programmable devices](#) (FP devices) are available for all five standard SiT8208 package sizes and can be configured to one's exact specification using the [Time Machine II](#), an USB powered MEMS oscillator programmer.

Customizable Features of the SiT8208 FP Devices Include

- Any frequency between 1 – 110 MHz
- Three frequency stability options, ± 20 PPM, ± 25 PPM, ± 50 PPM
- Two operating temperatures, -20 to 70°C or -40 to 85°C
- Five supply voltage options, 1.8V, 2.5V, 2.8V, 3.0V, and 3.3V
- Output drive strength

For more information regarding SiTime's field programmable solutions, visit <http://www.sitime.com/time-machine> and <http://www.sitime.com/fp-devices>.

SiT8208 is typically factory-programmed per customer ordering codes for volume delivery.

Dimensions and Patterns

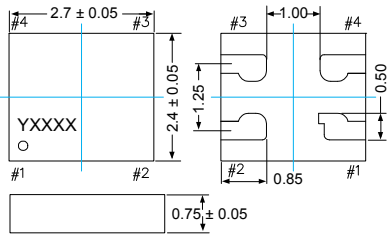
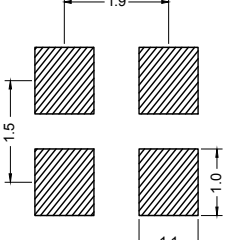
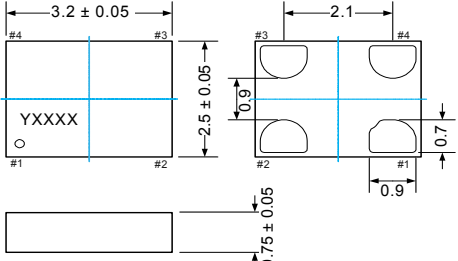
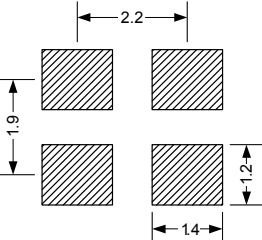
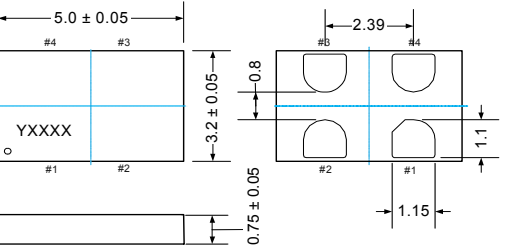
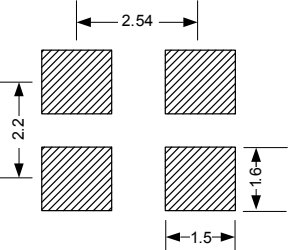
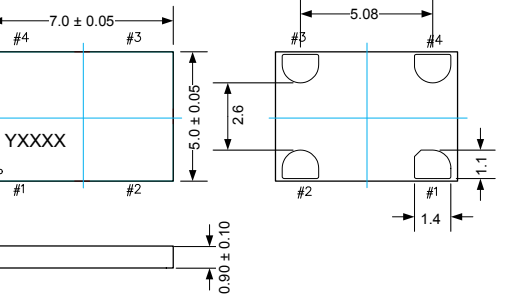
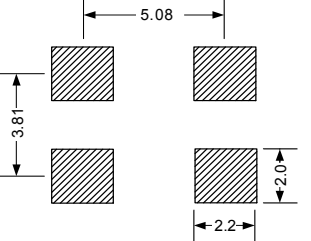
Package Size – Dimensions (Unit: mm) ^[9]	Recommended Land Pattern (Unit: mm) ^[10]
<p>2.7 x 2.4 x 0.75 mm (100% compatible with 2.5 x 2.0 mm footprint)</p>  <p>Top view dimensions: 2.7 ± 0.05 mm (width), 2.4 ± 0.05 mm (height). Pin #1 to #4 locations are marked. A 0.75 ± 0.05 mm wide lead is shown.</p> <p>Land pattern dimensions: 1.9 mm (width), 1.5 mm (height), 1.1 mm (width), 1.0 mm (height).</p>	 <p>Land pattern dimensions: 1.9 mm (width), 1.5 mm (height), 1.1 mm (width), 1.0 mm (height).</p>
<p>3.2 x 2.5 x 0.75 mm</p>  <p>Top view dimensions: 3.2 ± 0.05 mm (width), 2.5 ± 0.05 mm (height). Pin #1 to #4 locations are marked. A 0.75 ± 0.05 mm wide lead is shown.</p> <p>Land pattern dimensions: 2.2 mm (width), 1.9 mm (height), 1.4 mm (width), 1.2 mm (height).</p>	 <p>Land pattern dimensions: 2.2 mm (width), 1.9 mm (height), 1.4 mm (width), 1.2 mm (height).</p>
<p>5.0 x 3.2 x 0.75 mm</p>  <p>Top view dimensions: 5.0 ± 0.05 mm (width), 3.2 ± 0.05 mm (height). Pin #1 to #4 locations are marked. A 0.75 ± 0.05 mm wide lead is shown.</p> <p>Land pattern dimensions: 2.54 mm (width), 2.2 mm (height), 1.6 mm (height), 1.5 mm (width).</p>	 <p>Land pattern dimensions: 2.54 mm (width), 2.2 mm (height), 1.6 mm (height), 1.5 mm (width).</p>
<p>7.0 x 5.0 x 0.90 mm</p>  <p>Top view dimensions: 7.0 ± 0.05 mm (width), 5.0 ± 0.05 mm (height). Pin #1 to #4 locations are marked. A 0.90 ± 0.10 mm wide lead is shown.</p> <p>Land pattern dimensions: 5.08 mm (width), 3.81 mm (height), 2.2 mm (width), 2.0 mm (height).</p>	 <p>Land pattern dimensions: 5.08 mm (width), 3.81 mm (height), 2.2 mm (width), 2.0 mm (height).</p>

Notes:

9. Top marking: Y denotes manufacturing origin and XXXX denotes manufacturing lot number. The value of “Y” will depend on the assembly location of the device.
 10. A capacitor of value 0.1 μF between Vdd and GND is recommended.

Ordering Information

The Part No. Guide is for reference only. To customize and build an exact part number, use the SiTime [Part Number Generator](#).

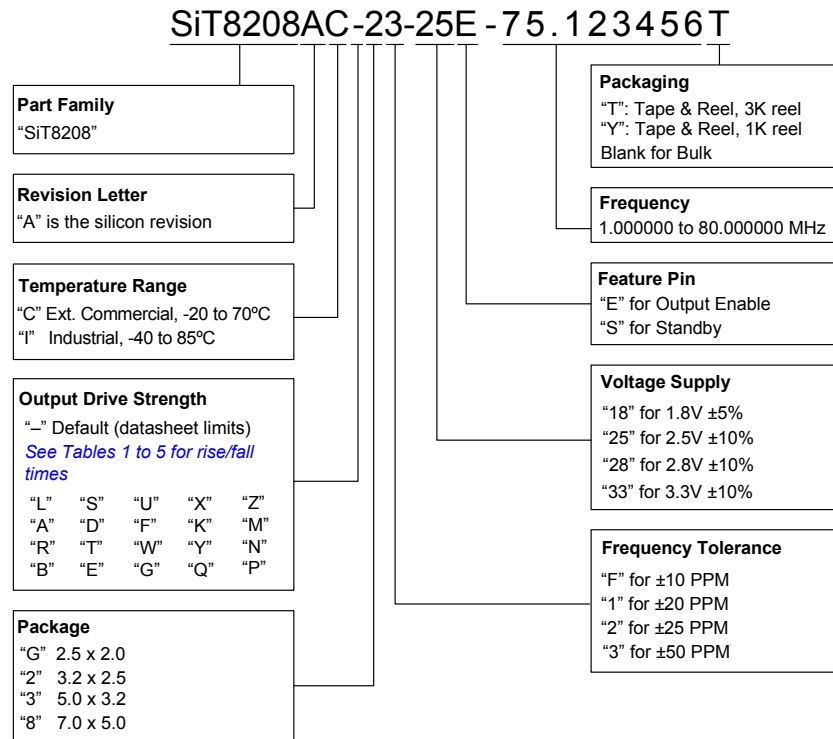

Additional Information

Document	Description	Download Link
Time Machine II	MEMS oscillator programmer	http://www.sitime.com/support/time-machine-oscillator-programmer
Field Programmable Oscillators	Devices that can be programmable in the field by Time Machine II	http://www.sitime.com/products/field-programmable-oscillators
Manufacturing Notes	Tape & Reel dimension, reflow profile and other manufacturing related info	http://www.sitime.com/component/docman/doc_download/85-manufacturing-notes-for-sitime-oscillators
Qualification Reports	RoHS report, reliability reports, composition reports	http://www.sitime.com/support/quality-and-reliability
Performance Reports	Additional performance data such as phase noise, current consumption and jitter for selected frequencies	http://www.sitime.com/support/performance-measurement-report
Termination Techniques	Termination design recommendations	http://www.sitime.com/support/application-notes
Layout Techniques	Layout recommendations	http://www.sitime.com/support/application-notes

© SiTime Corporation 2013. The information contained herein is subject to change at any time without notice. SiTime assumes no responsibility or liability for any loss, damage or defect of a Product which is caused in whole or in part by (i) use of any circuitry other than circuitry embodied in a SiTime product, (ii) misuse or abuse including static discharge, neglect or accident, (iii) unauthorized modification or repairs which have been soldered or altered during assembly and are not capable of being tested by SiTime under its normal test conditions, or (iv) improper installation, storage, handling, warehousing or transportation, or (v) being subjected to unusual physical, thermal, or electrical stress.

Disclaimer: SiTime makes no warranty of any kind, express or implied, with regard to this material, and specifically disclaims any and all express or implied warranties, either in fact or by operation of law, statutory or otherwise, including the implied warranties of merchantability and fitness for use or a particular purpose, and any implied warranty arising from course of dealing or usage of trade, as well as any common-law duties relating to accuracy or lack of negligence, with respect to this material, any SiTime product and any product documentation. Products sold by SiTime are not suitable or intended to be used in a life support application or component, to operate nuclear facilities, or in other mission critical applications where human life may be involved or at stake. All sales are made conditioned upon compliance with the critical uses policy set forth below.

CRITICAL USE EXCLUSION POLICY
BUYER AGREES NOT TO USE SITIME'S PRODUCTS FOR ANY APPLICATION OR IN ANY COMPONENTS USED IN LIFE SUPPORT DEVICES OR TO OPERATE NUCLEAR FACILITIES OR FOR USE IN OTHER MISSION-CRITICAL APPLICATIONS OR COMPONENTS WHERE HUMAN LIFE OR PROPERTY MAY BE AT STAKE.

SiTime owns all rights, title and interest to the intellectual property related to SiTime's products, including any software, firmware, copyright, patent, or trademark. The sale of SiTime products does not convey or imply any license under patent or other rights. SiTime retains the copyright and trademark rights in all documents, catalogs and plans supplied pursuant to or ancillary to the sale of products or services by SiTime. Unless otherwise agreed to in writing by SiTime, any reproduction, modification, translation, compilation, or representation of this material shall be strictly prohibited.

Supplemental Information

The Supplemental Information section is not part of the datasheet and is for informational purposes only.

Silicon MEMS Outperforms Quartz

Best Reliability

Silicon is inherently more reliable than quartz. Unlike quartz suppliers, SiTime has in-house MEMS and analog CMOS expertise, which allows SiTime to develop the most reliable products. Figure 1 shows a comparison with quartz technology.

Why is SiTime Best in Class:

- SiTime’s MEMS resonators are vacuum sealed using an advanced Epi-Seal™ process, which eliminates foreign particles and improves long term aging and reliability
- World-class MEMS and CMOS design expertise

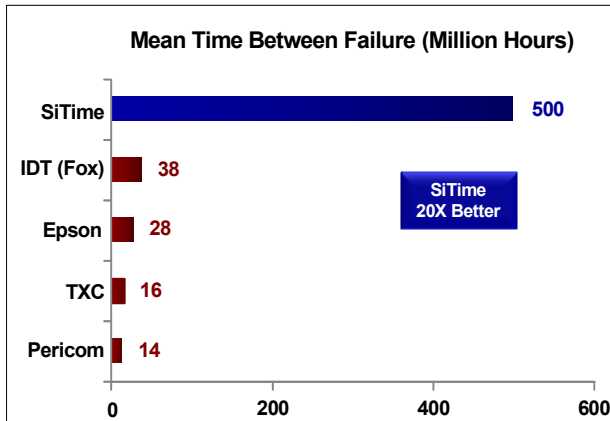

Figure 1. Reliability Comparison^[1]

Best Aging

Unlike quartz, MEMS oscillators have excellent long term aging performance which is why every new SiTime product specifies 10-year aging. A comparison is shown in Figure 2.

Why is SiTime Best in Class:

- SiTime’s MEMS resonators are vacuum sealed using an advanced Epi-Seal™ process, which eliminates foreign particles and improves long term aging and reliability
- Inherently better immunity of electrostatically driven MEMS resonator

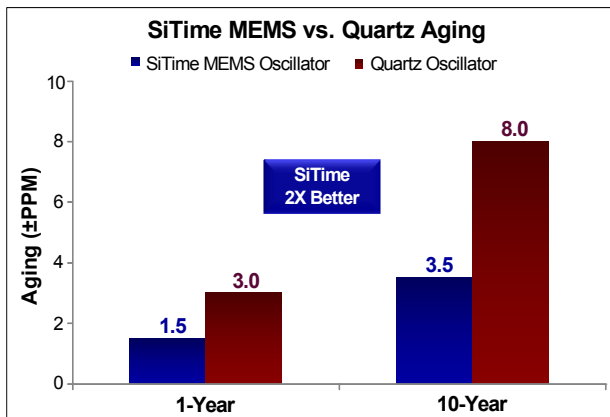

Figure 2. Aging Comparison^[2]

Best Electro Magnetic Susceptibility (EMS)

SiTime’s oscillators in plastic packages are up to 54 times more immune to external electromagnetic fields than quartz oscillators as shown in Figure 3.

Why is SiTime Best in Class:

- Internal differential architecture for best common mode noise rejection
- Electrostatically driven MEMS resonator is more immune to EMS

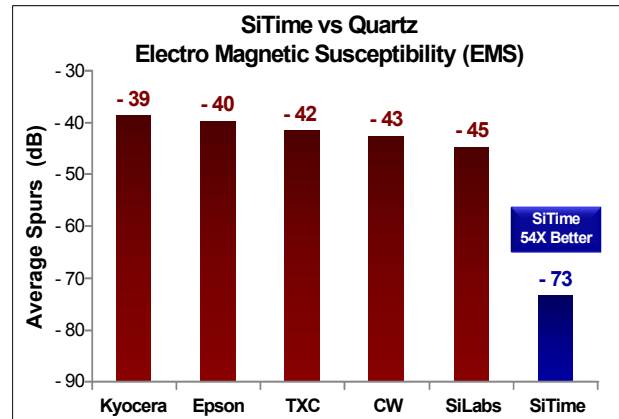

Figure 3. Electro Magnetic Susceptibility (EMS)^[3]

Best Power Supply Noise Rejection

SiTime’s MEMS oscillators are more resilient against noise on the power supply. A comparison is shown in Figure 4.

Why is SiTime Best in Class:

- On-chip regulators and internal differential architecture for common mode noise rejection
- Best analog CMOS design expertise

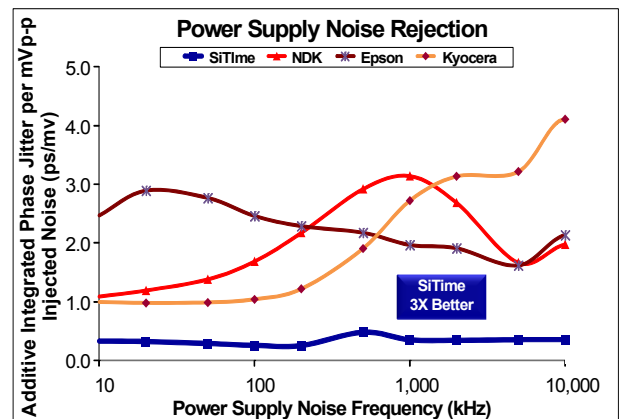

Figure 4. Power Supply Noise Rejection^[4]

Best Vibration Robustness

High-vibration environments are all around us. All electronics, from handheld devices to enterprise servers and storage systems are subject to vibration. Figure 5 shows a comparison of vibration robustness.

Why is SiTime Best in Class:

- The moving mass of SiTime’s MEMS resonators is up to 3000 times smaller than quartz
- Center-anchored MEMS resonator is the most robust design

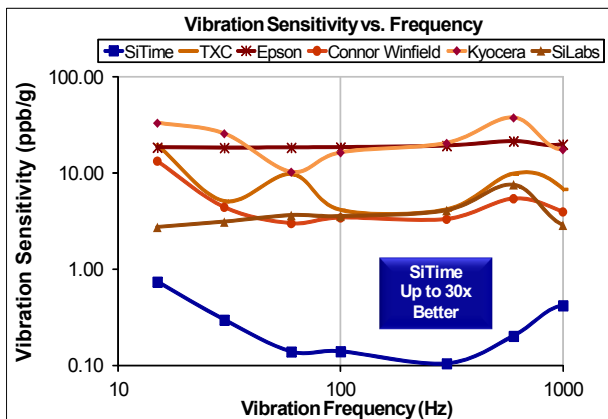

Figure 5. Vibration Robustness^[5]

Best Shock Robustness

SiTime’s oscillators can withstand at least 50,000 g shock. They all maintain their electrical performance in operation during shock events. A comparison with quartz devices is shown in Figure 6.

Why is SiTime Best in Class:

- The moving mass of SiTime’s MEMS resonators is up to 3000 times smaller than quartz
- Center-anchored MEMS resonator is the most robust design

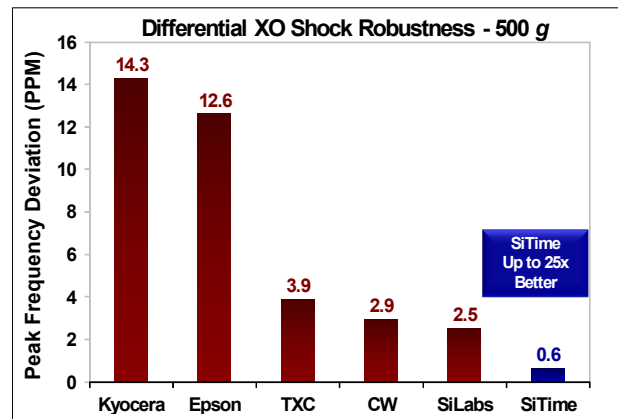

Figure 6. Shock Robustness^[6]

Notes:

1. Data Source: Reliability documents of named companies.
2. Data source: SiTime and quartz oscillator devices datasheets.
3. Test conditions for Electro Magnetic Susceptibility (EMS):
 - According to IEC EN61000-4.3 (Electromagnetic compatibility standard)
 - Field strength: 3V/m
 - Radiated signal modulation: AM 1 kHz at 80% depth
 - Carrier frequency scan: 80 MHz – 1 GHz in 1% steps
 - Antenna polarization: Vertical
 - DUT position: Center aligned to antenna
4. 50 mV pk-pk Sinusoidal voltage.

Devices used in this test:

 - SiTime, SiT9120AC-1D2-33E156.250000 - MEMS based - 156.25 MHz
 - Epson, EG-2102CA 156.2500M-PHPAL3 - SAW based - 156.25 MHz
 - TXC, BB-156.250MBE-T - 3rd Overtone quartz based - 156.25 MHz
 - Kyocera, KC7050T156.250P30E00 - SAW based - 156.25 MHz
 - Connor Winfield (CW), P123-156.25M - 3rd overtone quartz based - 156.25 MHz
 - SiLabs, Si590AB-BDG - 3rd overtone quartz based - 156.25 MHz
5. **Devices used in this test:** same as EMS test stated in Note 3.
6. Test conditions for shock test:
 - MIL-STD-883F Method 2002
 - Condition A: half sine wave shock pulse, 500-g, 1ms
 - Continuous frequency measurement in 100 μs gate time for 10 seconds

Devices used in this test: same as EMS test stated in Note 3
7. Additional data, including setup and detailed results, is available upon request to qualified customers. Please contact productsupport@sitime.com.

Document Feedback Form



The Smart Timing Choice™

SiTime values your input in improving our documentation. Click [here](#) for our online feedback form or fill out and email the form below to productsupport@sitime.com.

1. Does the Electrical Characteristics table provide complete information? Yes No

If No, what parameters are missing?

2. Is the organization of this document easy to follow? Yes No

If "No," please suggest improvements that we can make:

3. Is there any application specific information that you would like to see in this document? (Check all that apply)

EMI Termination recommendations Shock and vibration performance Other

If "Other," please specify:

4. Are there any errors in this document? Yes No

If "Yes", please specify (what and where):

5. Do you have additional recommendations for this document?

Name _____

Title _____

Company _____

Address _____

City / State or Province / Postal Code / Country _____

Telephone _____

Application _____

Would you like a reply? Yes No

Thank you for your feedback. Please click the email icon in your Adobe Reader tool bar and send to productsupport@sitime.com. Or you may use our [online feedback form](#).

X-ON Electronics

Largest Supplier of Electrical and Electronic Components

Click to view similar products for [Standard Clock Oscillators](#) category:

Click to view products by [SiTime](#) manufacturer:

Other Similar products are found below :

[601252](#) [F335-25](#) [F535L-33.333](#) [F535L-50](#) [ASV-20.000MHZ-LR-T](#) [ECS-2018-160-BN-TR](#) [MXO45HS-2C-66.6666MHZ](#) [SiT1602BI-22-33E-50.000000E](#) [SiT8209AI-32-33E-125.000000](#) [SIT8918AA-11-33S-50.000000G](#) [SM4420TEV-40.0M-T1K](#) [F335-24](#) [F335-40](#) [F535L-10](#) [F535L-12](#) [F535L-16](#) [F535L-24](#) [F535L-27](#) [F535L-48](#) [PE7744DW-100.0M](#) [CSX-750FCC14745600T](#) [ASF1-3.686MHZ-N-K-S](#) [XO57CTECNA3M6864](#) [ECS-2100A-147.4](#) [601251](#) [EP16E7E2H26.000MTR](#) [SIT8918AA-11-33S-16.000000G](#) [XO3003](#) [9120AC-2D2-33E212.500000](#) [9102AI-243N25E100.00000](#) [8208AC-82-18E-25.00000](#) [ASDK2-32.768KHZ-LR-T3](#) [8008AI-72-XXE-24.545454E](#) [8004AC-13-33E-133.33000X](#) [AS-4.9152-16-SMD-TR](#) [ASFL1-48.000MHZ-LC-T](#) [SIT8920AM-31-33E-25.0000](#) [DSC1028DI2-019.2000](#) [9121AC-2C3-25E100.00000](#) [9102AI-233N33E100.00000X](#) [9102AI-233N25E200.00000](#) [9102AI-232H25S125.00000](#) [9102AI-133N25E200.00000](#) [9102AC-283N25E200.00000](#) [9001AC-33-33E1-30.000](#) [3921AI-2CF-33NZ125.000000](#) [5730-1SF](#) [PXA000010](#) [8003AI-12-33S-40.00000Y](#) [1602BI-13-33S-19.200000E](#)