

Si MEMS OSCILLATOR

SERIES 2NM, EPOXY MOLDING 2.5X2.0MM SURFACE MOUNT PACKAGE



深圳市晶科鑫实业有限公司

样品承认书

客户代码:			
物料名称:	贴片晶振		
规格型号:	2520 MEMS OSC 96.000MHZ 1.8~3.3V -40~85°C LVCOMS		
P N/ SJK:	2NM96000C33YC		
环保属性:	<input checked="" type="checkbox"/> RoHS <input checked="" type="checkbox"/> REACH <input checked="" type="checkbox"/> HF <input type="checkbox"/> PAHS <input type="checkbox"/> 其它		
版次:	A1 2017-5-10 初版	最小包装:	3000pcs/real
湿敏等级:	一级		

承 认 签 章					
供 应 商 承 认			() 公 司 承 认		
制定	审核	核准	工程师	审核	批准
贺丹斌		黄灏东			
SJK 支持	18682088994 (Mr.黄)		盖章签署		
FAE_EMAIL	sjk-fae@q-crystal.com		日期		
日期			批示: <input type="checkbox"/> 接受 <input type="checkbox"/> 有条件接受		
备注:					



Si MEMS OSCILLATOR

SERIES 2NM, EPOXY MOLDING 2.5X2.0MM SURFACE MOUNT PACKAGE

1. ELECTRICAL SPECIFICATIONS

Standard atmospheric conditions

Unless otherwise specified, the standard range of atmospheric conditions for making measurement and tests are as follow:

Ambient temperature : 25±5°C

Relative humidity : 40%~70%

If there is any doubt about the results, measurement shall be made within the following limits:

Ambient temperature : 25±3°C

Relative humidity : 40%~70%

Measure equipment

Electrical characteristics measured by MD 37WX-05M or equivalent.

Crystal cutting type

The crystal is using AT CUT (thickness shear mode).

	Parameters		SYM	Electrical Spec.				Notes
				MIN	TYPE	MAX	UNITS	
1	Nominal Frequency			96.000000			MHZ	
2	Frequency Stability	AT 25°C		±10			PPM	
		Over Operating Temperature range		±15			PPM	
3	Operating Temperature		Topr	-40	25	85	°C	
4	Storage Temperature		Tstg	-55	~	125	°C	
5	Supply Voltage		VDD	3.3 ±10%			V	1.62~3.63V
6	Input Current		Icc			10	mA	
7	Enable Control			Yes				Pad1
8	Output Load : CMOS		CL	15			pF	
9	Output Voltage High		VoH	90% Vdd			V	
10	Output Voltage Low		VoL			10% Vdd	V	
11	Rise Time		Tr			5	ns	10%→ 90%VDD Level
12	Fall Time		Tf			5	ns	90%→ 10%VDD Level
13	Symmetry (Duty ratio)		TH/T	45	~	55	%	
14	Start-up Time		Tosc			10	ms	
15	Enable Voltage High		Vhi	70% Vdd			V	
16	Disable Voltage Low		Vlo			30% Vdd	V	
17	Aging			±3			ppm/yr.	1st. Year at 25°C
18	Output Disable Delay Time		T off			150	us	
19	Output Enable Delay Time		T on			150	us	

电话：0755-88352810-837(Mr.huang) 传真：0755-88353718 <http://www.q-crystal.com>

公司地址：深圳市龙岗区天安云谷产业园一期3栋C座12楼1204~1206室

Si MEMS OSCILLATOR

SERIES 2NM, EPOXY MOLDING 2.5X2.0MM SURFACE MOUNT PACKAGE

20	Phase Jitter (12KHZ~20MHZ)			0.5	1.0	ps	
----	----------------------------	--	--	-----	-----	----	--

2. DIMENSIONS (Units :mm)

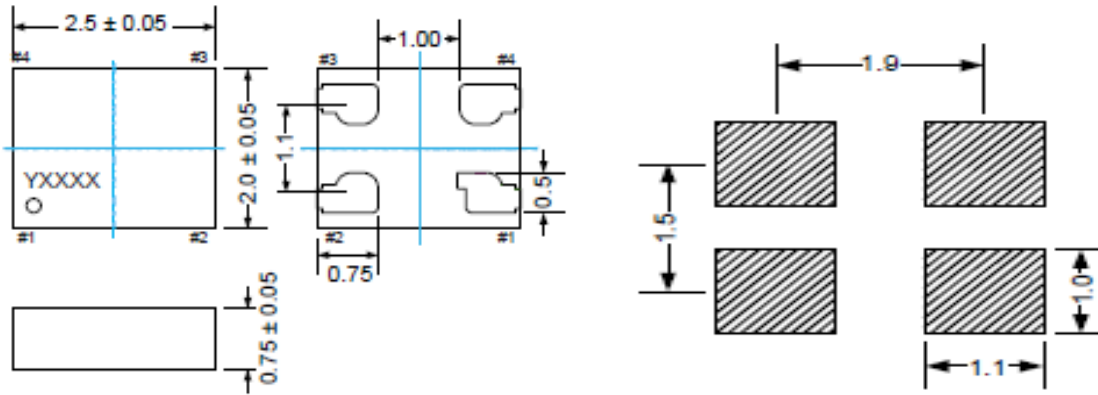

3. MARKING

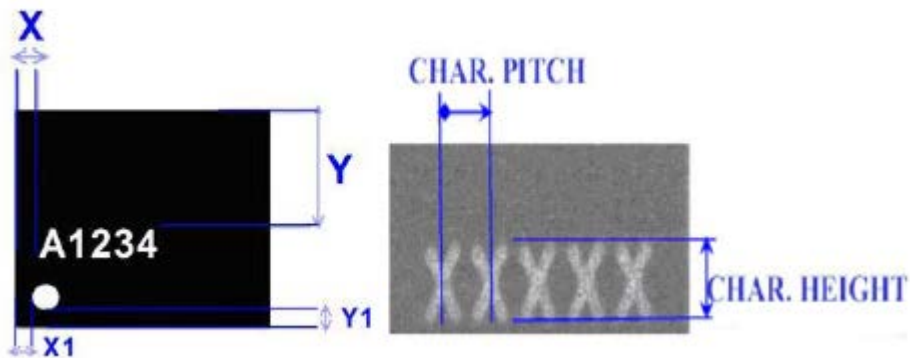
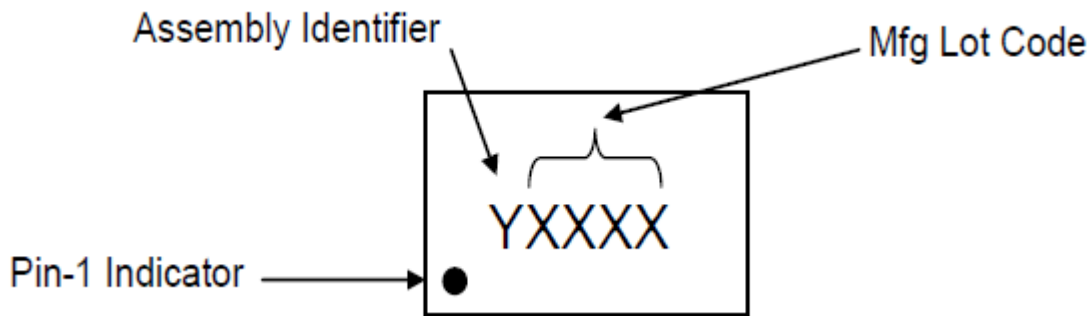

Si MEMS OSCILLATOR

SERIES 2NM, EPOXY MOLDING 2.5X2.0MM SURFACE MOUNT PACKAGE

Table 1. Marking Dimensions for Package Type

Package	X	X1	Y	Y1	Y2	Char Height	Char Pitch	Pin 1 Dot diameter
2.5 x 2.0	0.30	0.30	0.85	0.25	N/A	0.45	0.35	0.25
3.2 x 2.5	0.30	0.20	1.10	0.35	N/A	0.45	0.45	0.25
5.0 x 3.2	0.35	0.35	1.50	0.5	N/A	0.45	0.50	0.25
7.0 x 5.0	1.00	0.70	2.70	0.7	N/A	0.45	0.55	0.35

4. TEST CIRCUIT

Control input (output enable/disable)

Logic 1 or open on pad 1: Oscillator output

Logic 0 on pad 1 : Disable output to high impedance

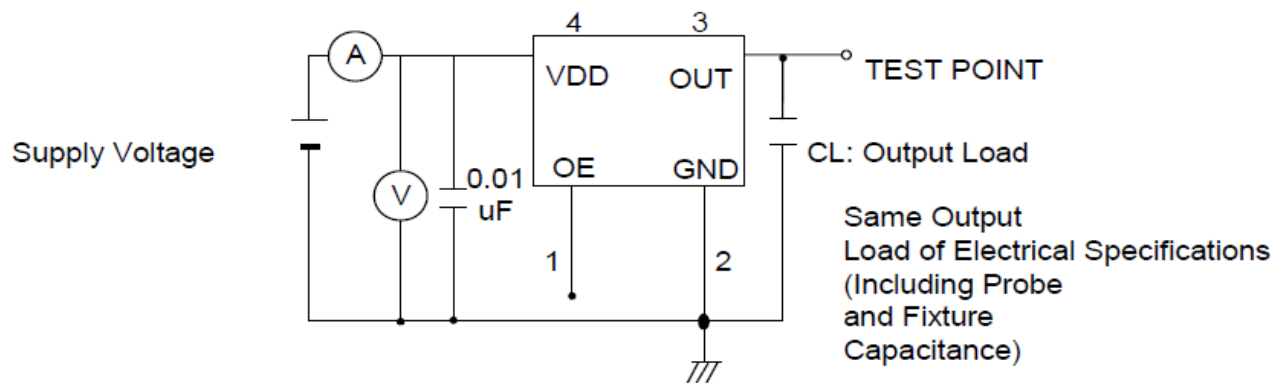

5. WAVEFORM CONDITIONS

Waveform measurement system should have a min. bandwidth of 5 times the frequency being tested.

Si MEMS OSCILLATOR

SERIES 2NM, EPOXY MOLDING 2.5X2.0MM SURFACE MOUNT PACKAGE

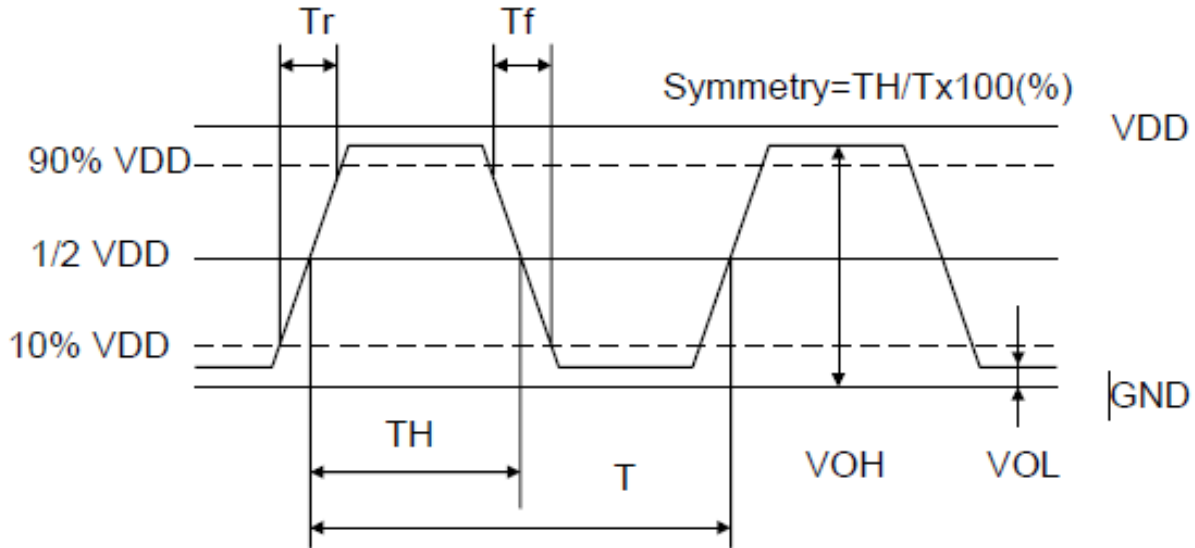

6. OUTPUT ENABLE / DISABLE DELAY

The following figure shows the oscillator timing during normal operation. Note that when the device is in standby, the oscillator stops. When standby is released, the oscillator starts and stable oscillator output occurs after a short delay.

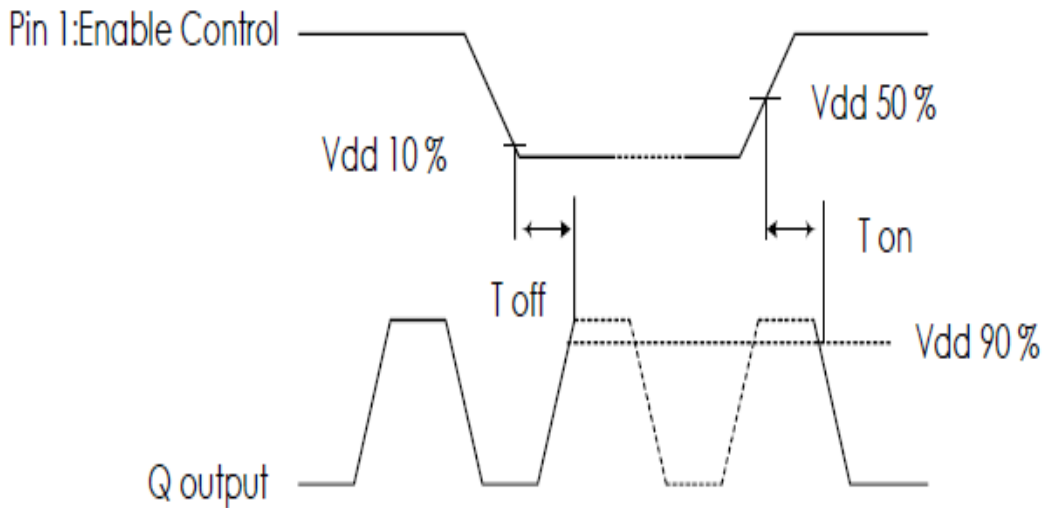

8. SUGGESTED REFLOW PROFILE

Si MEMS OSCILLATOR

SERIES 2NM, EPOXY MOLDING 2.5X2.0MM SURFACE MOUNT PACKAGE

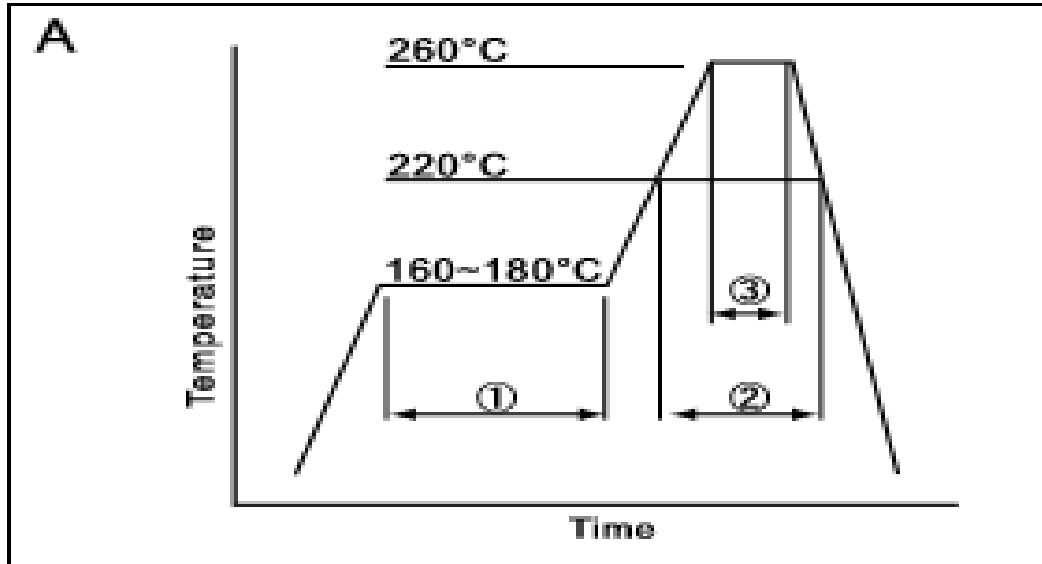

①	Preheat	160~180°C	120sec.
②	Primary heat	220°C	60sec.
③	Peak	260°C	10sec. max

Total time : 200 sec. Max / Solder melting point :220 °C

7. RELIABILITY TEST SPECIFICATION

1.Mechanical Endurance

No.	Test Item	Test Methods	REF. DOC
1	Drop Test	75 cm height,3 times on concrete floor .	JIS C6701
2	Mechanical Shock	Device are shocked to half sine wave (1000 G) three mutually perpendicular axes each 3 times. 0.5m sec. duration time	MIL-STD-202F
3	Vibration	Frequency range 10 ~ 2000 Hz Amplitude 1.52 mm/20G Sweep time 20 minutes Perpendicular axes each test time 4 Hrs (Total test time 12 Hrs)	MIL-STD-883E
4	Gross Leak	Standard Sample For Automatic Gross Leak Detector, Test Pressure: 2kg / cm ²	MIL-STD-883E
5	Fine Leak	Helium Bomging 4.5 kgf / cm ² for 2 Hrs	
6	Solderability	Temperature 245 °C ± 5°C Immersing depth 0.5 mm minimum Immersion time 5 ± 1 seconds Flux Rosin resin methyl alcohol solvent (1 : 4)	MIL-STD-883E

2.Environmental Endurance

Si MEMS OSCILLATOR

SERIES 2NM, EPOXY MOLDING 2.5X2.0MM SURFACE MOUNT PACKAGE

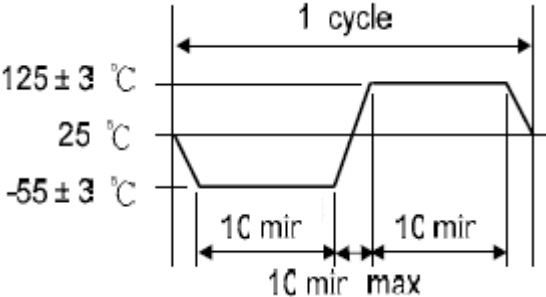
No.	Test Item	Test Methods	REF. DOC
1	Resistance To Soldering Heat	Pre-heat temperature 125 °C Pre-heat time 60 ~ 120 sec. Test temperature 260 ± 5 °C Test time 10 ± 1 sec.	MIL-STD-202F
2	High Temp. Storage	+ 125 °C ± 3 °C for 1000 ± 12 Hrs	MIL-STD-883E
3	Low Temp. Storage	- 40 °C ± 3 °C for 1000 ± 12 Hrs	
4	Thermal Shock	Total 100 cycles of the following temperature cycle 	MIL-STD-883E
5	Pressure Cooker Storage	121 ± 3 °C , RH100% , 2 bar , 240 Hrs	JIS C6701
6	High Temp & Humidity	85 °C ± 3 °C , RH 85% , 1000 Hrs	JIS C5023

X-ON Electronics

Largest Supplier of Electrical and Electronic Components

Click to view similar products for [Standard Clock Oscillators](#) category:

Click to view products by [SJK](#) manufacturer:

Other Similar products are found below :

[EP1400SJTSC-125.000M](#) [601137](#) [601252](#) [CSX750FBC-24.000M-UT](#) [CSX750FBC-33.333M-UT](#) [CSX750FCC-3.6864M-UT](#) [F335-12](#) [F335-25](#) [F535L-50](#) [DSC506-03FM2](#) [ASA-20.000MHZ-L-T](#) [ASA-25.000MHZ-L-T](#) [ASA-27.000MHZ-L-T](#) [ASV-20.000MHZ-LR-T](#) [ECS-2018-160-BN-TR](#) [EL13C7-H2F-125.00M](#) [MXO45HS-2C-66.6666MHZ](#) [NBXDBB017LN1TAG](#) [NBXHBA019LN1TAG](#) [SiT1602BI-22-33E-50.000000E](#) [SIT8003AC-11-33S-2.04800X](#) [SiT8256AC-23-33E-156.250000X](#) [SIT8918AA-11-33S-50.000000G](#) [SM4420TEV-40.0M-T1K](#) [SMA4306-TL-H](#) [F335-24](#) [F335-40](#) [F335-50](#) [F535L-10](#) [F535L-12](#) [F535L-16](#) [F535L-24](#) [F535L-27](#) [F535L-48](#) [PE7744DW-100.0M](#) [CSX750FBC-20.000M-UT](#) [CSX-750FBC33333000T](#) [CSX750FBC-4.000M-UT](#) [CSX750FBC-7.3728M-UT](#) [CSX750FBC-8.000M-UT](#) [CSX-750FCC14745600T](#) [CSX750FCC-16.000M-UT](#) [CSX-750FCC40000000T](#) [CSX750FCC-4.000M-UT](#) [ASA-22.000MHZ-L-T](#) [ASA2-26.000MHZ-L-T](#) [ASA-40.000MHZ-L-T](#) [ASA-48.000MHZ-L-T](#) [ASA-60.000MHZ-L-T](#) [ASF1-3.686MHZ-N-K-S](#)