



Image may differ from product. See technical specification for details.

W 6300-2RS1

Stainless steel deep groove ball bearing with integral sealing

Stainless steel single row deep groove ball bearing with seals or shields on both sides, provide greater chemical and corrosion resistance. As with deep groove ball bearings generally, they are particularly versatile, have low friction and are optimized for low noise and low vibration, which enables high rotational speeds. They accommodate radial and axial loads in both directions, are easy to mount, and require less maintenance than other bearing types. The integral sealing can significantly prolong bearing service life because it keeps lubricant in the bearings and contaminants out.

- Greater chemical and corrosion resistance
- Integral sealing prolongs bearing service life
- Typical benefits of single row deep groove ball bearings

Overview

Dimensions

Bore diameter	10 mm
Outside diameter	35 mm
Width	11 mm

Properties

Filling slots	Without
Number of rows	1
Locating feature, bearing outer ring	None
Bore type	Cylindrical
Cage	Sheet metal
Matched arrangement	No
Radial internal clearance	CN
Tolerance class	Normal
Material, bearing	Stainless steel
Coating	Without
Sealing	Seal on both sides
Sealing type	Contact
Lubricant	Grease
Relubrication feature	Without

Performance

Basic dynamic load rating	7.02 kN
Basic static load rating	3.4 kN
Limiting speed	15 000 r/min

Logistics

Product net weight	0.052 kg
eClass code	23-05-08-01
UNSPSC code	31171504

Technical specification

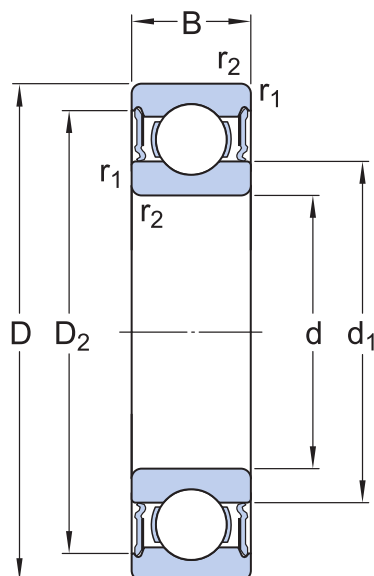

Dimensions

d	10 mm	Bore diameter
D	35 mm	Outside diameter
B	11 mm	Width
d ₁	≈ 17.7 mm	Shoulder diameter
d ₂	≈ 17.7 mm	Recess diameter
D ₂	≈ 29.3 mm	Recess diameter
r _{1,2}	min. 0.6 mm	Chamfer dimension

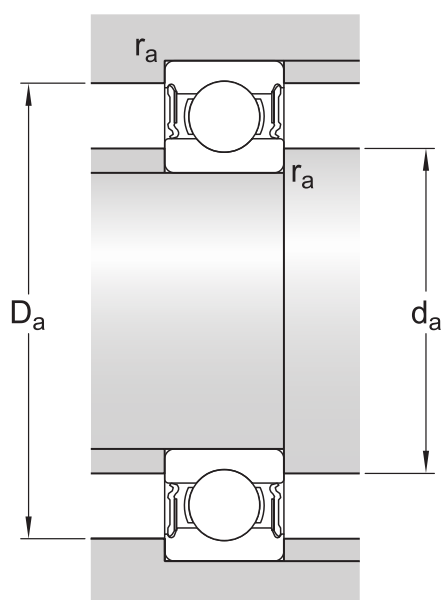

Abutment dimensions

d _a	min. 14 mm	Diameter of shaft abutment
d _a	max. 17.5 mm	Diameter of shaft abutment
D _a	max. 31 mm	Diameter of housing abutment
r _a	max. 0.6 mm	Radius of shaft or housing fillet

Calculation data

Basic dynamic load rating	C	7.02 kN
Basic static load rating	C ₀	3.4 kN
Fatigue load limit	P _u	0.146 kN
Limiting speed		15 000 r/min
Minimum load factor	k _r	0.035
Calculation factor	f ₀	11.2

Mass

Mass bearing	0.052 kg
--------------	----------

Tolerance class

Dimensional tolerances

Normal

Radial run-out

Normal

X-ON Electronics

Largest Supplier of Electrical and Electronic Components

Click to view similar products for [Screws & Fasteners](#) category:

Click to view products by [SKF](#) manufacturer:

Other Similar products are found below :

[5721-1440-1/4-SS](#) [0098.0094](#) [0098.9206](#) [59781-6](#) [0098.9212](#) [6292-1](#) [690432-1](#) [699161-000](#) [700989](#) [7230-3](#) [72609-02](#) [CAPTIVE JACK](#)
[SCREW](#) [73542-02](#) [CAPTIVE SHORT THUMBSCREW](#) [745564-1](#) [7680](#) [809704-1](#) [8700](#) [8860220](#) [9521](#) [992763-3](#) [1-18024-0](#) [A168P1](#) [1-](#)
[24921-1](#) [125416-1](#) [1301810313](#) [1-306131-6](#) [1301830042](#) [1458](#) [1-59781-3](#) [18029-4](#) [NBX-10953](#) [NUT-16-3P-HEX-NICKEL](#) [20993.45098](#)
[21004-1](#) [21009-4](#) [21014-5](#) [21021-2](#) [CA24037A01](#) [22987-4](#) [240632-1](#) [240632-2](#) [89506-9801](#) [2504](#) [9031](#) [9-1393249-2](#) [2.5NZPNBU](#) [26-](#)
[0048PP](#) [27210-1](#) [27210-8](#) [9318](#) [9520](#)