

600mA, 1.2MHz, Micropower Synchronous Step-Up Converter

General Description

The AAT1217 is a high efficiency, synchronous, fixed frequency, step-up converter designed for single-cell or dual-cell alkaline, NiMH, or NiCd battery-powered applications. The high 1.2MHz switching frequency and completely integrated control circuitry minimize the total solution footprint area while maintaining excellent regulation, ripple, and transient response throughout the full load range.

Light load mode operation and low quiescent current allow the AAT1217 to maintain high efficiency performance for light load conditions. With a 1.2A peak inductor current limit, the AAT1217 is capable of delivering 100mA to the load from a single AA cell, 400mA from dual AA cells, or up to 500mA from a single-cell lithium-ion battery. The AAT1217 has a 0.85V start-up voltage with operation down to 0.5V.

The AAT1217 is available in a Pb-free, space-saving low profile (1mm) 6-pin TSOT23 or 6-pin SOT23 package and is rated over the -40°C to +85°C ambient temperature range.

Features

- V_{IN} Operation Range: 0.5V to V_{OUT}
- V_{OUT} Range: 2.5V to 5.5V
- 100mA Output from a Single AA Cell Input
- 400mA Output from a Dual AA Cell Input
- 500mA Output from a Single Li+ Cell Input
- High Efficiency: Up to 93% Efficiency
- Low Start-Up Voltage: 0.85V Typical
- Internal Synchronous Rectifier
 - $V_{OUT} \leq 4.5V$: No External Schottky Diode
- Fixed Frequency Pulse Width Modulation (PWM) Current-Mode Control Scheme with Internal Compensation
- 1.2MHz Fixed Switching Frequency
- 1.2A Current Limit
- Light Load Mode Operation
- Over-Current Protection
- EMI Reduction Anti-Ringing Control Circuitry
- Low Shutdown Current: <1.0 μ A
- -40°C to +85°C Ambient Temperature Range
- Low Profile (1mm) TSOT23-6 or SOT23-6 Package

Applications

- Cellular and Smart Phones
- Digital Still and Video Cameras
- Microprocessors and DSP Core Supplies
- MP3 Player
- Portable Instruments
- Wireless and DSL Modems

Typical Application

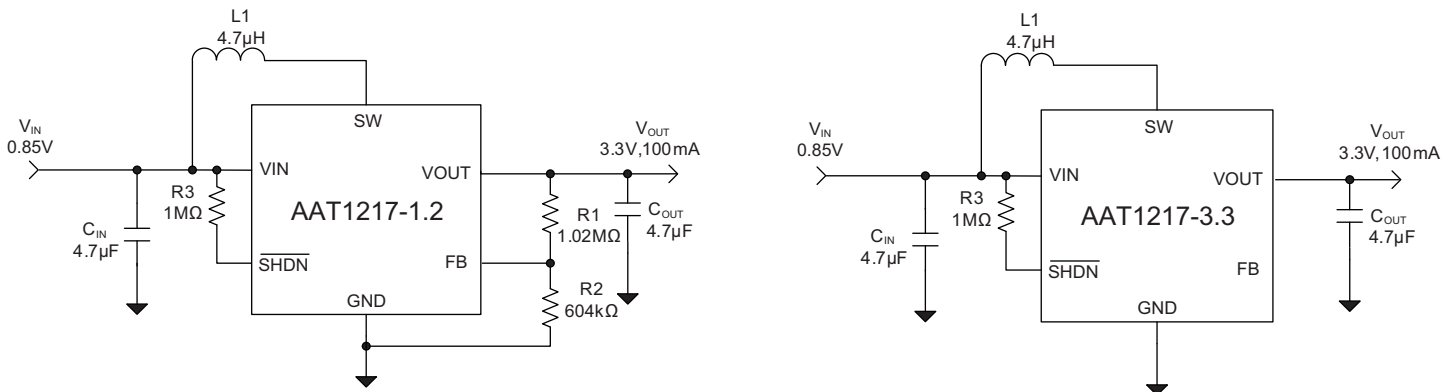

AAT1217**600mA, 1.2MHz, Micropower Synchronous Step-Up Converter****Pin Descriptions**

Pin #	Symbol	Function
1	SW	Power Switch Pin. Ties to the drains of the PMOS synchronous rectifier and the NMOS switch.
2	GND	Ground Pin
3	FB	Feedback Input Pin. Connect FB to the center point of the external resistor divider. The feedback threshold voltage is 1.23V.
4	$\overline{\text{SHDN}}$	Shutdown Signal Input. Logic high enables the IC. Logic low disables the IC. Shutdown current is $<1\mu\text{A}$.
5	VOUT	Power Output Pin. Tied to the source of the PMOS synchronous rectifier.
6	VIN	Power Supply Input. Must be closely decoupled to GND, Pin 2, with a $4.7\mu\text{F}$ or greater ceramic capacitor.

Pin Configuration

**TSOT23-6/SOT23-6
(Top View)**

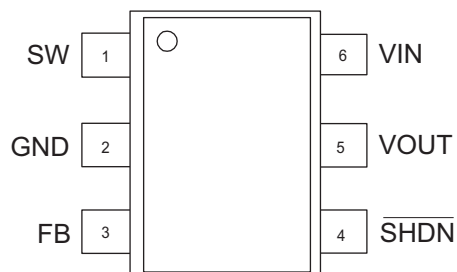

600mA, 1.2MHz, Micropower Synchronous Step-Up Converter**Absolute Maximum Ratings¹**

Symbol	Description	Value	Units
V_{IN}	Input Supply Voltage	-0.3 to 6	V
V_{SW}	SW Voltage	-0.3 to 6	V
V_{FB}, V_{SHDN}	FB, SHDN Voltages	-0.3 to 6	V
V_{OUT}	VOUT Voltage	-0.3 to 6	V
T_A	Operating Ambient Temperature Range ²	-40 to 85	°C
$T_{STORAGE}$	Storage Temperature Range	-65 to 150	°C
T_{LEAD}	Lead Temperature (Soldering, 10s)	300	°C
T_J	Operating Junction Temperature Range ²	-40 to 150	°C

Thermal Information³

Symbol	Description	Value	Units
θ_{JA}	Maximum Thermal Resistance	TSOT23-6	190
		SOT23-6	150
P_D	Maximum Power Dissipation	TSOT23-6	526
		SOT23-6	667

1. Absolute Maximum Ratings are those values beyond which the life of a device may be impaired.

2. T_J is calculated from the ambient temperature T_A and power dissipation P_D according to the following formula: $T_J = T_A + P_D \times \theta_{JA}$.

3. Mounted on an FR4 board.

600mA, 1.2MHz, Micropower Synchronous Step-Up Converter

Electrical Characteristics¹

$V_{IN} = 1.2V$, $V_{OUT} = 3.3V$, $T_A = 25^\circ C$, unless otherwise noted.

Symbol	Description	Conditions	Min	Typ	Max	Units
V_{IN}	Minimum Start-Up Voltage	$I_{OUT} = 1mA$		0.85	1	V
	Minimum Operating Voltage	$V_{SHDN} = V_{IN}$		0.5	0.65	
V_{OUT}	Output Voltage Range		2.5		5.5	V
	Output Voltage Accuracy ³	$I_{OUT} = 10mA$; $T_A = -40^\circ C$ to $+85^\circ C$	-4		+4	%
V_{FB}	Reference Voltage	$T_A = -40^\circ C$ to $+85^\circ C$	1.192	1.230	1.268	V
$\frac{\Delta V_{OUT}}{V_{OUT}} / \frac{\Delta V_{IN}}{V_{IN}}$	Reference Voltage Line Regulation	$V_{IN} = 1.2V$ to $2.4V$, $I_{OUT} = 10mA$, $V_{OUT} = 3.3V$		0.2		%/V
		$V_{IN} = 2.4V$ to $4.2V$, $I_{OUT} = 10mA$, $V_{OUT} = 5.0V$		0.4		
$\frac{\Delta V_{OUT}}{V_{OUT}} / \frac{\Delta I_{OUT}}{I_{OUT}}$	Reference Voltage Load Regulation	$V_{IN} = 1.2V$, $I_{OUT} = 10mA$ to $100mA$, $V_{OUT} = 3.3V$		0.003		%mA
		$V_{IN} = 3.6V$, $I_{OUT} = 10mA$ to $400mA$, $V_{OUT} = 5.0V$		0.004		
I_Q	Quiescent Current (Shutdown)	$V_{SHDN} = 0$		0.01	1	μA
	Quiescent Current (Active)	Measured on V_{OUT} , $V_{SHDN} = V_{IN}$		300	500	
$I_{LN MOS}$	NMOS Switch Leakage	$V_{SW} = 5V$		0.1	5	μA
$I_{LP MOS}$	PMOS Switch Leakage	$V_{SW} = 0V$		0.1	5	μA
$R_{DS(ON)L}$	NMOS Switch ON Resistance	$V_{OUT} = 3.3V$		0.35		Ω
		$V_{OUT} = 5V$		0.30		
$R_{DS(ON)H}$	PMOS Switch ON Resistance	$V_{OUT} = 3.3V$		0.60		Ω
		$V_{OUT} = 5V$		0.55		
I_{CL}	NMOS Current Limit		750	1200		mA
$\Delta t(I_{CL})$	Current Limit Delay to Output			40		ns
D_{MAX}	Maximum Duty Cycle	$V_{FB} = 1.15V$, $T_A = -40^\circ C$ to $+85^\circ C$	80	85		%
F_{OSC}	Switching Frequency	$T_A = -40^\circ C$ to $+85^\circ C$	0.9	1.2	1.5	MHz
V_{SHDN}	SHDN Input Low				0.35	V
	SHDN Input High		1.00			
I_{SHDN}	SHDN Input Current	$V_{SHDN} = 5.5V$		0.01	1	μA
T_{SD}	Thermal Shutdown			160		$^\circ C$
		Hysteresis		20		

1. Specifications over the temperature range are guaranteed by design, characterization, and correlation with statistical process controls.
 2. Not including the current into internal resistance divider.
 3. For fixed 3.3V and 5.0V output voltage version. The adjustable output voltage is guaranteed by reference voltage accuracy.

600mA, 1.2MHz, Micropower Synchronous Step-Up Converter

Typical Characteristics

Efficiency vs. Output Current

($V_{OUT} = 3.3V$; $T_A = 25^\circ C$)

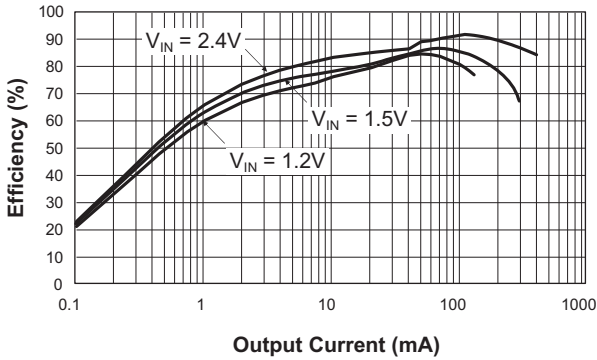

Efficiency vs. Output Current

($V_{OUT} = 5V$; $T_A = 25^\circ C$)

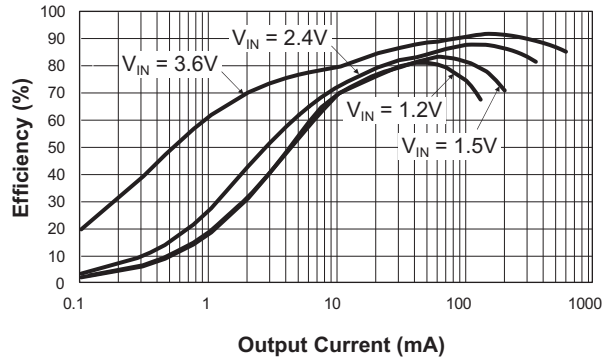

Output Voltage vs. Output Current

($V_{OUT} = 3.3V$; $T_A = 25^\circ C$)

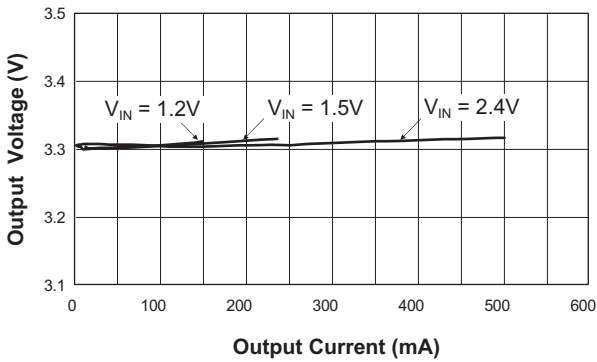

Output Voltage vs. Output Current

($V_{OUT} = 5V$; $T_A = 25^\circ C$)

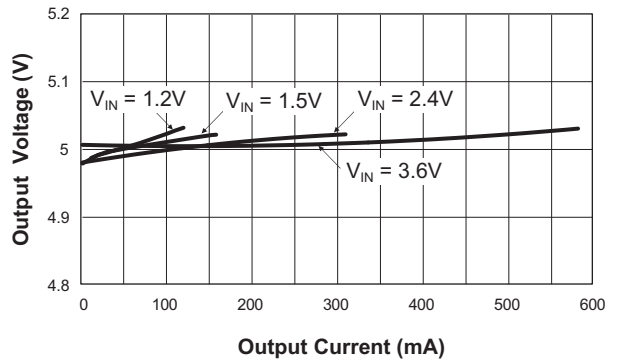

Minimum Start-Up Voltage vs. Output Current

($V_{OUT} = 3.3V$; $T_A = 25^\circ C$)

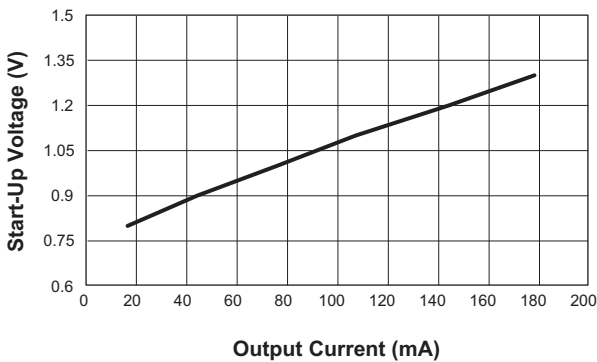

Maximum Output Current vs. Input Voltage

($L = 4.7\mu H$; $T_A = 25^\circ C$)

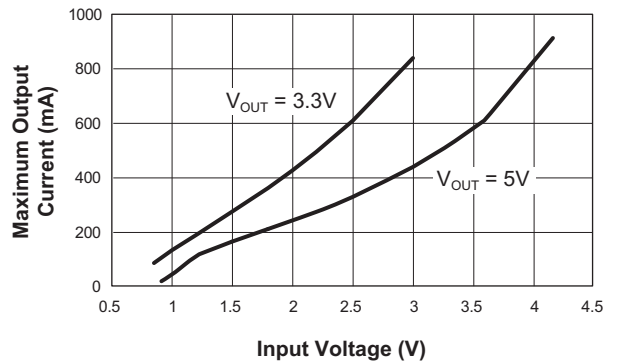

600mA, 1.2MHz, Micropower Synchronous Step-Up Converter

Typical Characteristics

No Load Input Current vs. Input Voltage
($V_{OUT} = 3.3V$; $T_A = 25^\circ C$; No Load)

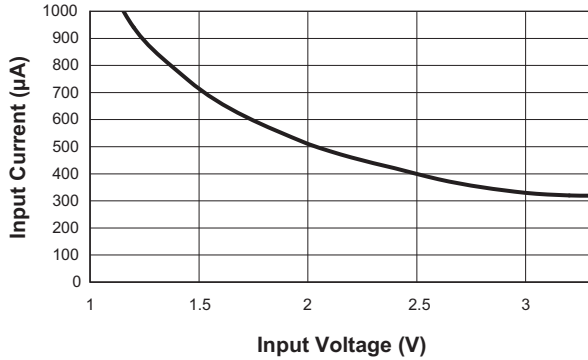

Output Voltage vs. Temperature

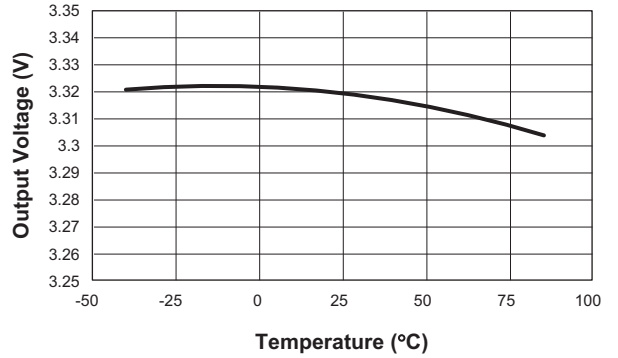

Light Load Mode Operation
($V_{IN} = 1.8V$; $V_{OUT} = 3.3V$; $I_{OUT} = 5mA$)

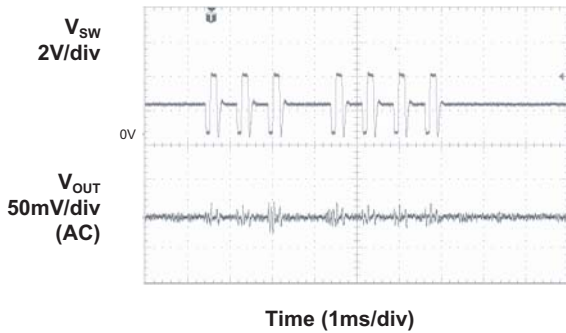

Anti-Ringing Operation at SW
($V_{IN} = 2.4V$; $V_{OUT} = 5V$; $I_{OUT} = 20mA$)

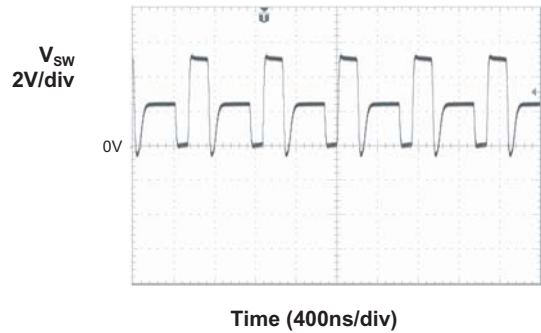

Load Transient Response
($V_{IN} = 1.5V$; $V_{OUT} = 3.3V$; $C_{FF} = 100pF$)

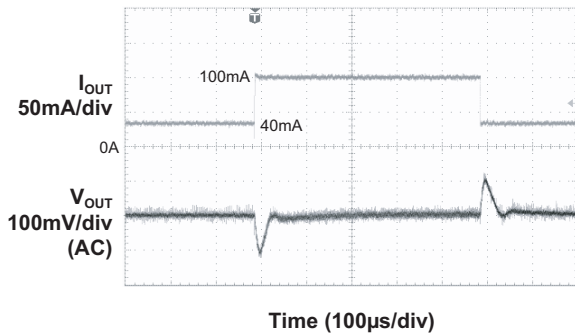

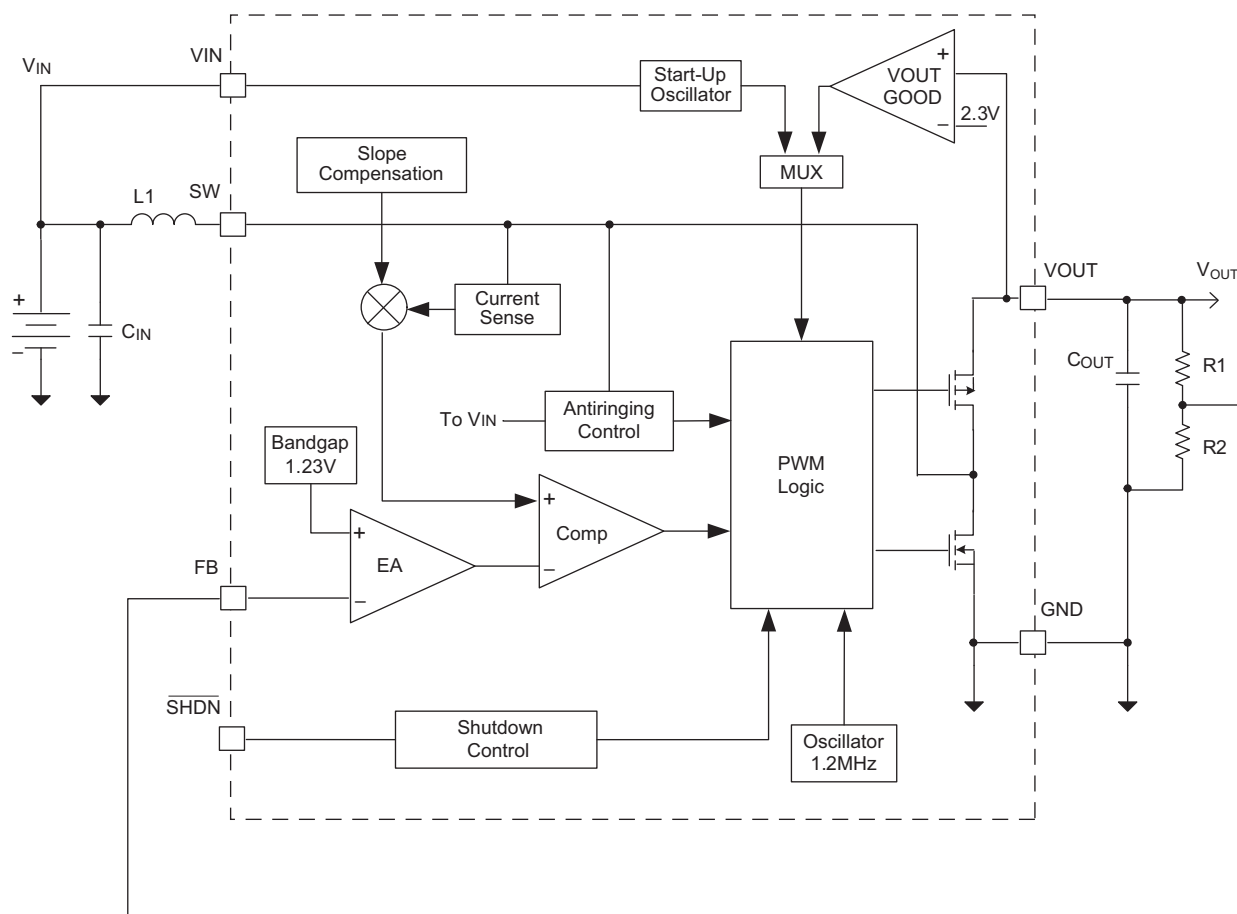
600mA, 1.2MHz, Micropower Synchronous Step-Up Converter**Functional Block Diagram****Functional Description**

The AAT1217 is a synchronous step-up DC-DC converter. It utilizes internal MOSFET switches to achieve high efficiency over the full load current range. It operates at a fixed switching frequency of 1.2MHz, and uses the slope compensated current mode pulse width modulation (PWM) architecture. The device can operate with an input voltage below 1V; the typical start-up voltage is 0.85V.

Synchronous Rectification

The AAT1217 integrates a synchronous rectifier to improve efficiency as well as to eliminate the need for an external Schottky diode. The synchronous rectifier is used to reduce the conduction loss contributed by the forward voltage of an external Schottky diode. The synchronous

rectifier is realized by a P-channel MOSFET (PMOS) with gate control circuitry that incorporates relatively complicated timing concerns. An external Schottky diode is required when the output voltage is greater than 4.5V.

Low Voltage Start-Up

The AAT1217 can start-up with supply voltages down to 0.85V. During start-up, the internal low voltage start-up circuitry controls the internal NMOS switch. The AAT1217 leaves the start-up mode once V_{OUT} exceeds 2.3V. An internal comparator (VOUT GOOD) monitors the output voltage and places the chip into normal operation once V_{OUT} exceeds 2.3V. The AAT1217's control circuitry is biased by V_{IN} during start-up and biased by V_{OUT} once V_{OUT} exceeds V_{IN} . When V_{OUT} exceeds V_{IN} , the AAT1217's operation will be independent of V_{IN} .

600mA, 1.2MHz, Micropower Synchronous Step-Up Converter

Current Mode Operation

The AAT1217 is based on a slope compensated current mode PWM control topology. It operates at a fixed frequency of 1.2MHz. At the beginning of each clock cycle, the main switch (NMOS) is turned on and the inductor current starts to ramp. After the maximum duty cycle or the sense current signal equals the error amplifier (EA) output, the main switch is turned off and the synchronous switch (PMOS) is turned on. This control topology features cycle-by-cycle current limiting which can prevent the main switch from overstress and the external inductor from saturating.

Light Load Mode Operation

At very light load, the AAT1217 automatically switches into light load mode operation to improve efficiency. During this mode, the PWM control will skip some pulses to maintain regulation. If the load increases and the output voltage drops, the device will automatically switch back to normal PWM mode and maintain regulation.

Anti-Ringing Control

An anti-ringing circuitry is included to remove the high frequency ringing that appears on the SW pin when the inductor current goes to zero. In this case, a ringing on the SW pin is induced due to remaining energy stored in parasitic components of switch and inductor. The anti-ringing circuitry clamps the voltage internally to the battery voltage and therefore dampens this ringing.

Device Shutdown

When $\overline{\text{SHDN}}$ is set logic high, the AAT1217 is put into active mode operation. If $\overline{\text{SHDN}}$ is set logic low, the device is put into shutdown mode and consumes less than 1 μ A of current. After start-up, the internal circuitry is supplied by V_{OUT} , however, if shutdown mode is enabled, the internal circuitry will be supplied by the input source again.

Application Information

Adjustable Output Voltage

An external resistor divider is used to set the output voltage. The output voltage of the switching regulator (V_{OUT}) is determined by the following equation:

$$V_{\text{OUT}} = 1.23\text{V} \cdot \left(1 + \frac{R1}{R2}\right)$$

Table 1 lists the recommended resistor values for particular output voltage settings.

V_{OUT}	$R1(\Omega)$	$R2(\Omega)$
3.3V	1.02M	604k
5.0V	1.02M	332k

Table 1: Resistor Selection for Output Voltage Setting.

Fixed Output Voltage

The AAT1217 has two fixed output voltage options: 3.3V and 5V. An internal resistor divider is connected to the FB pin inside the package which eliminates the need for external feedback resistors. When designing with the fixed output voltage option, remember to leave the FB pin open; otherwise the output voltage will be affected. However, a feed-forward capacitor can still be added between the FB and VOUT pins to enhance the control loop performance.

Inductor Selection

The high switching frequency of 1.2MHz allows for small surface mount inductors. For most applications, the AAT1217 operates with inductors from 2.2 μ H to 10 μ H. Use the following equations to select the proper inductor value for a particular application condition:

$$I_{\text{PEAK}} = I_{\text{DC}} + \frac{\Delta I_L}{2}$$

$$I_{\text{DC}} = \frac{I_{\text{OUT}} \cdot V_{\text{OUT}}}{\eta \cdot V_{\text{IN}}}$$

$$\Delta I_L = \frac{V_{\text{IN}} \cdot D}{L \cdot F_{\text{SW}}}; \quad D = \frac{V_{\text{OUT}} - V_{\text{IN}}}{V_{\text{OUT}}}$$

$$\Delta I_L = \frac{V_{\text{IN}} \cdot (V_{\text{OUT}} - V_{\text{IN}})}{L \cdot F_{\text{SW}} \cdot V_{\text{OUT}}}$$

600mA, 1.2MHz, Micropower Synchronous Step-Up Converter

$$I_{PEAK} = \frac{I_{OUT} \cdot V_{OUT}}{\eta \cdot V_{IN}} + \frac{V_{IN} \cdot (V_{OUT} - V_{IN})}{2L \cdot F_{SW} \cdot V_{OUT}}$$

- I_{PEAK} Peak Inductor Current
- I_{DC} DC Component (Average) of the Inductor Current
- ΔI_L Peak-Peak Inductor Ripple Current
- I_{OUT} Output (Load) Current
- V_{OUT} Output Voltage
- V_{IN} Input Voltage
- η AAT1217 Efficiency (consult the performance graphs in the "Typical Characteristics" section of the data sheet)
- D Steady-State Duty Cycle
- F_{SW} Switching Frequency
- L Inductor Value

For a given chosen inductor value and application conditions make sure the peak inductor current does not exceed the maximum current rating of the selected vendor's inductor. For optimum load transient and efficiency, low DCR inductors should be selected. Table 2 lists some typical surface mount inductors that are suitable for typical AAT1217 applications.

Input Capacitor

A surface mount 4.7µF or greater, X5R or X7R, ceramic capacitor is suggested for the input capacitor. The input capacitor provides a low impedance loop for the edges of pulsed current drawn by the AAT1217. Low ESR/ESL

X7R and X5R ceramic capacitors are ideal for this function. To minimize stray inductance, the capacitor should be placed as close as possible to the IC. This keeps the high frequency content of the input current localized, minimizing EMI and input voltage ripple. Always examine the ceramic capacitor DC voltage coefficient characteristics to get the proper value. For example, the capacitance of a 10µF, 6.3V, X5R ceramic capacitor with 5.0V DC applied is actually about 6µF.

A laboratory test set-up typically consists of two long wires running from the bench power supply to the evaluation board input voltage pins. The inductance of these wires, along with the low-ESR ceramic input capacitor, can create a high Q network that may affect converter performance. This problem often becomes apparent in the form of excessive ringing in the output voltage during load transients which can produce errors in loop phase and gain measurements. Since the inductance of a short printed circuit board (PCB) trace feeding the input voltage is significantly lower than the power leads from the bench power supply, most actual applications do not exhibit this problem. In applications where the input power source lead inductance cannot be reduced to a level that does not affect the converter performance, a high ESR tantalum or aluminum electrolytic capacitor should be placed in parallel with the low ESR, ESL bypass input ceramic capacitor. The introduction of the high ESR capacitor dampens the high Q network and stabilizes the AAT1217.

Part Number	L (µH)	Max DCR (mΩ)	Rated DC Current (A)	Size WxLxH (mm)
Sumida CDH28D11/S	2.2	123	1.15	3x3.3x1.2
	4.7	238	0.75	
	10	431	0.53	
Coiltronics SD3112	2.2	140 (typ)	1.12	3.1x3.1x1.2
	4.7	246 (typ)	0.8	
	10	446 (typ)	0.55	
TDK VLF3012A	2.2	100	1	2.8x2.6x1.2
	4.7	190	0.74	
	10	410	0.49	
Sumida CR43	2.2	71.2	1.75	4.3x4.8x3.5
	4.7	108.7	1.15	
	10	182	1.04	
Sumida CDRH4D28	2.2	31.3	2.04	5.0x5.0x3.0
	4.7	72	1.32	
	10	128	1	
Toko D53LC	4.7	45	1.87	5.0x5.0x3.0
	10	90	1.33	

Table 2: Typical Surface Mount Inductors.

600mA, 1.2MHz, Micropower Synchronous Step-Up Converter**Output Capacitor**

The output capacitor limits the output ripple and provides holdup during large load transitions. A 4.7 μ F to 10 μ F, X5R or X7R, ceramic capacitor is suggested for the output capacitor. Typically the recommended capacitor range provides sufficient bulk capacitance to stabilize the output voltage during large load transitions and has the ESR and ESL characteristics necessary for low output voltage ripple.

In addition, the output voltage droop during load transient is dominated by the capacitance of the ceramic output capacitor. During a step increase in load current, the ceramic output capacitor alone supplies the load current until the loop responds. Within several switching cycles, the loop responds and the inductor current increases to match the load current demand. Larger output capacitor values help to reduce the voltage droop during large load current transients.

External Diode Selection

An external Schottky diode is required when the output voltage is above 4.5V. The Schottky diode is optional for output voltages \leq 4.5V, but can improve efficiency by about 2% to 3%.

Load Disconnect in Shutdown

In conventional synchronous step-up converters, a conduction path exists from input to output through the backgate (body diode) of the P-channel MOSFET during shutdown. Special application circuitry can disconnect the load from the battery during shutdown (see Figure 1).

PCB Layout Guidance

The AAT1217 typically operates at 1.2MHz. This is a considerably high frequency for DC-DC converters. PCB layout is important to guarantee satisfactory performance. It is recommended to make traces of the power loop, especially where the switching node is involved, as short and wide as possible. First of all, the inductor, input and output capacitor should be as close as possible to the device. Feedback and shutdown circuits should avoid the proximity of large AC signals involving the power inductor and switching node. The optional rectifier diode (D1 in Figure 1) can improve efficiency and alleviate the stress on the integrated MOSFETs. The diode should also be close to the inductor and the chip to form the shortest possible switching loop. While the two-layer PCB shown in Figures 2 and 3 is enough for most applications, large and integral multi-layer ground planes are ideal for high power applications. Large areas of copper have lower resistance and help to dissipate heat. The converter's ground should join the system ground to which it supplies power at one point only. Figure 1 is the schematic for a highly efficient load disconnect application circuit for the AAT1217. An example PCB layout for the AAT1217 is shown in Figures 2 and 3.

AAT1217

600mA, 1.2MHz, Micropower Synchronous Step-Up Converter

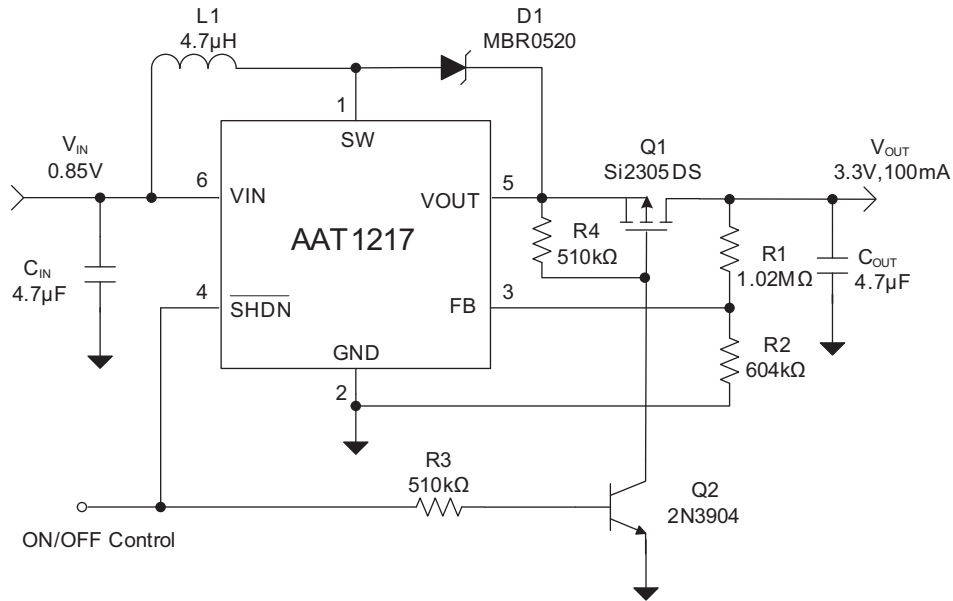

Figure 1: AAT1217 High Efficiency Load Disconnect Application Circuit.

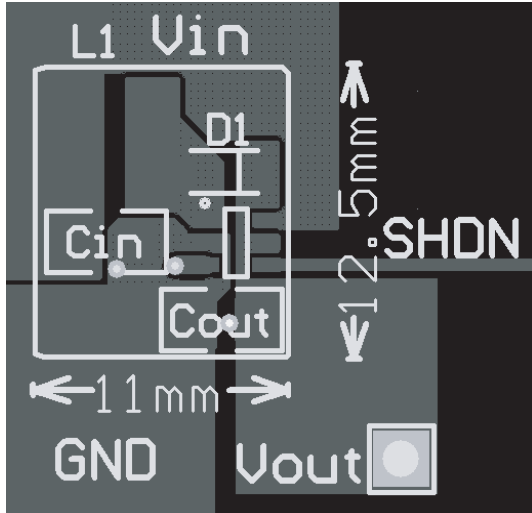

Figure 2: AAT1217 Evaluation Board Layout Example Top Layer.

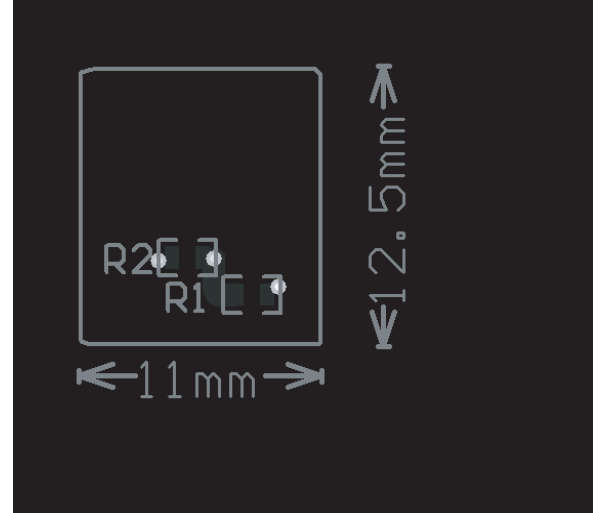

Figure 3: AAT1217 Evaluation Board Layout Example Bottom Layer.

AAT1217

600mA, 1.2MHz, Micropower Synchronous Step-Up Converter

Ordering Information

Output Voltage ¹	Package	Marking ²	Part Number (Tape and Reel) ³
Adj.	TSOT23-6	VZXY	AAT1217ICA-1.2-T1
Fixed 3.3V	TSOT23-6	WAXYY	AAT1217ICA-3.3-T1
Fixed 5.0V	TSOT23-6	WBXY	AAT1217ICA-5.0-T1
Fixed 3.3V	SOT23-6	3CXY	AAT1217IGU-3.3-T1



Skyworks Green™ products are compliant with all applicable legislation and are halogen-free. For additional information, refer to *Skyworks Definition of Green™*, document number SQ04-0074.

Package Information

TSOT23-6

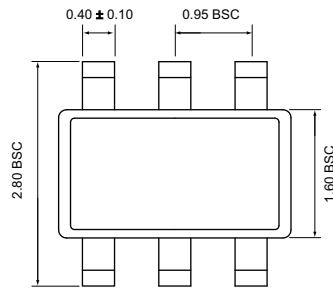

Top View

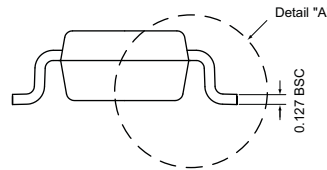

End View

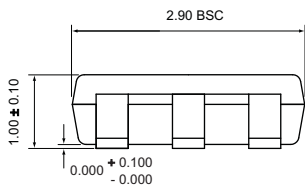

Side View

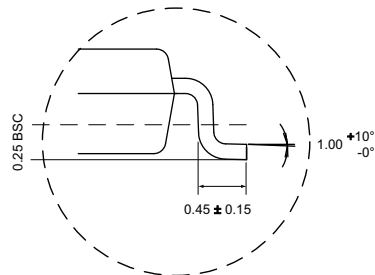

Detail "A"

All dimensions in millimeters.

1. Please contact sales for other voltage options.
2. XYY = Assembly and Date Code.
3. Sample stock is generally held on part numbers listed in **BOLD**.

600mA, 1.2MHz, Micropower Synchronous Step-Up Converter

SOT23-6

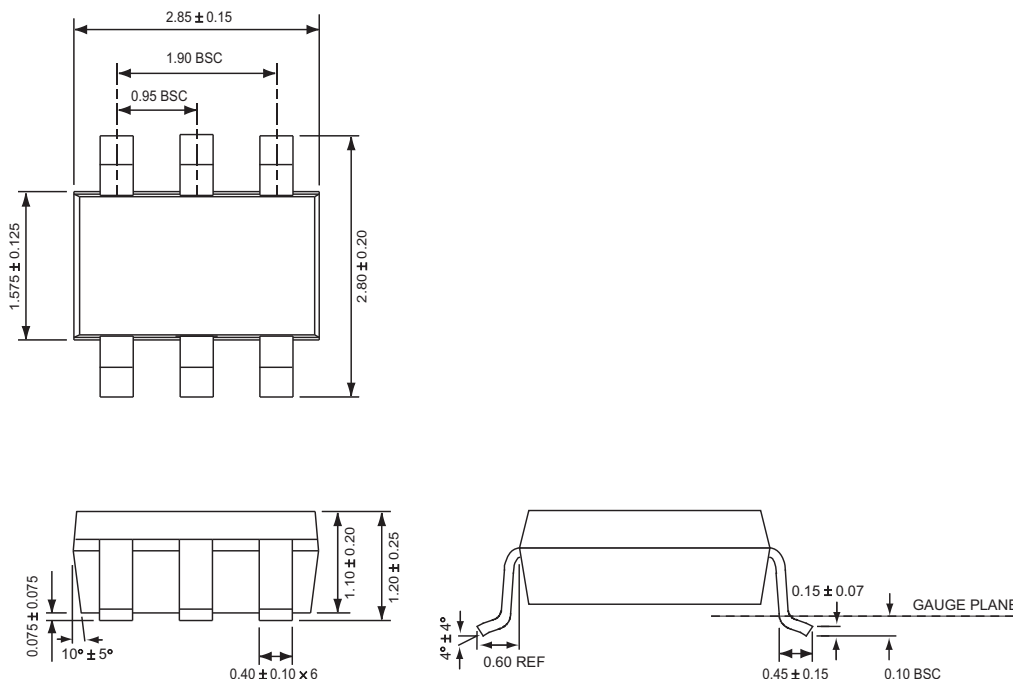

All dimensions in millimeters.

Copyright © 2012, 2013 Skyworks Solutions, Inc. All Rights Reserved.

Information in this document is provided in connection with Skyworks Solutions, Inc. ("Skyworks") products or services. These materials, including the information contained herein, are provided by Skyworks as a service to its customers and may be used for informational purposes only by the customer. Skyworks assumes no responsibility for errors or omissions in these materials or the information contained herein. Skyworks may change its documentation, products, services, specifications or product descriptions at any time, without notice. Skyworks makes no commitment to update the materials or information and shall have no responsibility whatsoever for conflicts, incompatibilities, or other difficulties arising from any future changes.

No license, whether express, implied, by estoppel or otherwise, is granted to any intellectual property rights by this document. Skyworks assumes no liability for any materials, products or information provided hereunder, including the sale, distribution, reproduction or use of Skyworks products, information or materials, except as may be provided in Skyworks Terms and Conditions of Sale.

THE MATERIALS, PRODUCTS AND INFORMATION ARE PROVIDED "AS IS" WITHOUT WARRANTY OF ANY KIND, WHETHER EXPRESS, IMPLIED, STATUTORY, OR OTHERWISE, INCLUDING FITNESS FOR A PARTICULAR PURPOSE OR USE, MERCHANTABILITY, PERFORMANCE, QUALITY OR NON-INFRINGEMENT OF ANY INTELLECTUAL PROPERTY RIGHT; ALL SUCH WARRANTIES ARE HEREBY EXPRESSLY DISCLAIMED. SKYWORKS DOES NOT WARRANT THE ACCURACY OR COMPLETENESS OF THE INFORMATION, TEXT, GRAPHICS OR OTHER ITEMS CONTAINED WITHIN THESE MATERIALS. SKYWORKS SHALL NOT BE LIABLE FOR ANY DAMAGES, INCLUDING BUT NOT LIMITED TO ANY SPECIAL, INDIRECT, INCIDENTAL, STATUTORY, OR CONSEQUENTIAL DAMAGES, INCLUDING WITHOUT LIMITATION, LOST REVENUES OR LOST PROFITS THAT MAY RESULT FROM THE USE OF THE MATERIALS OR INFORMATION, WHETHER OR NOT THE RECIPIENT OF MATERIALS HAS BEEN ADVISED OF THE POSSIBILITY OF SUCH DAMAGE.

Skyworks products are not intended for use in medical, lifesaving or life-sustaining applications, or other equipment in which the failure of the Skyworks products could lead to personal injury, death, physical or environmental damage. Skyworks customers using or selling Skyworks products for use in such applications do so at their own risk and agree to fully indemnify Skyworks for any damages resulting from such improper use or sale.

Customers are responsible for their products and applications using Skyworks products, which may deviate from published specifications as a result of design defects, errors, or operation of products outside of published parameters or design specifications. Customers should include design and operating safeguards to minimize these and other risks. Skyworks assumes no liability for applications assistance, customer product design, or damage to any equipment resulting from the use of Skyworks products outside of stated published specifications or parameters.

Skyworks, the Skyworks symbol, and "Breakthrough Simplicity" are trademarks or registered trademarks of Skyworks Solutions, Inc., in the United States and other countries. Third-party brands and names are for identification purposes only, and are the property of their respective owners. Additional information, including relevant terms and conditions, posted at www.skyworksinc.com, are incorporated by reference.

X-ON Electronics

Largest Supplier of Electrical and Electronic Components

Click to view similar products for [Switching Voltage Regulators](#) category:

Click to view products by [Skyworks](#) manufacturer:

Other Similar products are found below :

[FAN53610AUC33X](#) [FAN53611AUC123X](#) [FAN48610BUC33X](#) [FAN48610BUC45X](#) [FAN48617UC50X](#) [R3](#) [430464BB](#) [KE177614](#)
[FAN53611AUC12X](#) [MAX809TTR](#) [NCV891234MW50R2G](#) [NCP81103MNTXG](#) [NCP81203PMNTXG](#) [NCP81208MNTXG](#)
[NCP81109GMNTXG](#) [SCY1751FCCT1G](#) [NCP81109JMNTXG](#) [AP3409ADNTR-G1](#) [NCP81241MNTXG](#) [LTM8064IY](#) [LT8315EFE#TRPBF](#)
[LTM4664EY#PBF](#) [LTM4668AIY#PBF](#) [NCV1077CSTBT3G](#) [XCL207A123CR-G](#) [MPM54304GMN-0002](#) [MPM54304GMN-0004](#)
[MPM54304GMN-0003](#) [AP62300Z6-7](#) [MP8757GL-P](#) [MIC23356YFT-TR](#) [LD8116CGL](#) [HG2269M/TR](#) [OB2269](#) [XD3526](#) [U6215A](#) [U6215B](#)
[U6620S](#) [LTC3412IFE](#) [LT1425IS](#) [MAX25203BATJA/VY+](#) [MAX77874CEWM+](#) [XC9236D08CER-G](#) [MP3416GJ-P](#) [MP5461GC-Z](#)
[MPQ4415AGQB-Z](#) [MPQ4590GS-Z](#) [MAX38640BENT18+T](#) [MAX77511AEWB+](#) [MAX20406AFOD/VY+](#)