

DATA SHEET

OLI500: Miniature High CMR, High-Speed Logic Gate Optocoupler for Hybrid Assembly

Features

- Performance guaranteed over -55 °C to +125 °C ambient temperature range
- Guaranteed minimum Common Mode Rejection (CMR) transient immunity, >1000 V/μs
- 1500 V_{DC} electrical isolation
- Low-Power Schottky Transistor-Transistor Logic (LSTTL)/ Transistor-to-Transistor Logic (TTL) compatible
- High-speed, 10 Mbps typical
- Low input LED current
- Similar to 6N134, 6N137, and HCPL2601
- Radiation tolerant

Description

The OLI500 is suitable for high-speed digital interfacing applications, elimination of ground loops, and input/output buffering. Each OLI500 has an LED and integrated high-speed detector mounted and coupled in a miniature custom ceramic package, that provides 1500 V_{DC} electrical isolation between the input and output.

The light from the LED is collected by the photodiode in the integrated detector and amplified by a high gain linear amplifier that drives a Schottky-clamped open collector output transistor. Typical propagation delay for the OLI500 is 60 ns. The internal shield improves common mode transient immunity to 1000 V/μs minimum.

Device mounting is achieved by a standard hybrid assembly with non-conductive epoxies. Gold or aluminum wire bonding can be used to make electrical connections for maximum placement flexibility.

Note: *Certain cleaning processes may be harmful to this device. Contact Isolink for details.*

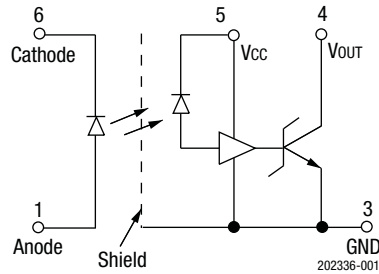

Figure 1. OLI500 Block Diagram

Figure 1 shows the OLI500 functional block diagram. Table 1 provides the OLI500 absolute maximum ratings. Table 2 provides the OLI500 electrical specifications.

Figures 2 through 5 illustrate the OLI500 typical performance characteristics. Figure 6 shows the OLI500 switching test circuit. Figure 7 provides the OLI500 package dimensions.

Table 1. OLI500 Absolute Maximum Ratings¹

Parameter	Symbol	Minimum	Maximum	Units
<i>Coupled</i>				
Input to output isolation voltage ²	V _{DC}	-1500	+1500	V
Storage temperature range	T _{STG}	-65	+150	°C
Operating temperature range	T _A	-55	+125	°C
Mounting temperature range (3 minutes maximum)			+240	°C
Total power dissipation	P _D		+170	mW
<i>Input Diode</i>				
Average input current	I _{DD}		20	mA
Peak forward current (≤1 ms duration)	I _F		40	mA
Reverse voltage	V _R		5	V
Power dissipation	P _D		36	mW
<i>Output Detector</i>				
Peak output current			25	mA
Supply voltage (1 minute maximum)	V _{CC}		7	V
Output collector power dissipation	P _D		40	mW

¹ Exposure to maximum rating conditions for extended periods may reduce device reliability. There is no damage to the device with only one parameter set at the limit and all other parameters set at or below their nominal value. Exceeding any of the limits listed here may result in permanent damage to the device.

² Measured between pins 1 and 6 shorted together, and pins 2, 3, 4, and 5 shorted together. T_A = 25°C and duration = 1 s.

ESD HANDLING: *Although this device is designed to be as robust as possible, electrostatic discharge (ESD) can damage this device. This device must be protected at all times from ESD when handling or transporting. Static charges may easily produce potentials of several kilovolts on the human body or equipment, which can discharge without detection. Industry-standard ESD handling precautions should be used at all times.*

Table 2. OLI500 Electrical Specifications¹
(T_A = -55 °C to +125 °C, Unless Otherwise Noted)

Parameter	Symbol	Test Condition	Minimum	Typical	Maximum	Units
Low-level output voltage ²	V _{OL}	V _{CC} = 5.5 V, I _{OL} = 10.0 mA, I _F = 5.0 mA		0.4	0.6	V
High-level output current ²	I _{OH}	V _{CC} = V _O = 5.5 V, I _F = 250.0 μA		5.0	250.0	μA
High-level supply current ²	I _{CCH}	V _{CC} = 5.5 V, I _F = 0 mA		11.0	16.0	mA
Low-level supply current ²	I _{CCL}	V _{CC} = 5.5 V, I _F = 5.0 mA		16.0	20.0	mA
Input:						
Forward voltage	V _F	I _F = 10.0 mA		1.8	2.5	V
Reverse breakdown voltage	B _{VR}	I _R = 10.0 μA	3.0			V
Output leakage current ³	I _{L_O}	R _H ≤ 50%, T _A = 25 °C, V _{L_O} = 1500.0 V _{DC}			1.0	μA
Propagation delay time: ²						
Logic high to low	t _{PHL}	I _F = 7.5 mA, V _{CC} = 5.0 V, R _L = 510.0 Ω		60.0	140.0	ns
Logic low to high	t _{PLH}	I _F = 7.5 mA, V _{CC} = 5.0 V, R _L = 510.0 Ω		60.0	140.0	ns
Common mode transient immunity: ²						
High output level	CM _H	V _{CM} = 50.0 V peak, V _O (minimum) = 2.0 V, R _L = 510.0 Ω, I _F = 0 mA, T _A = 25 °C	1000	10,000		V/μs
Low output level	CM _L	V _{CM} = 50.0 V peak, V _O (maximum) = 0.8 V, R _L = 510.0 Ω, I _F = 5.0 mA, T _A = 25 °C	1000	10,000		V/μs

¹ Performance is guaranteed only under the conditions listed in the above table.

² A ceramic bypass capacitor (0.01 μF to 0.1 μF) is required between pins 3 and 5 to stabilize the operation of the amplifier.

³ Measured between pins 1 and 6 shorted together, and pins 2, 3, 4, and 5 shorted together. T_A = 25 °C and duration = 1 s.

Typical Performance Characteristics

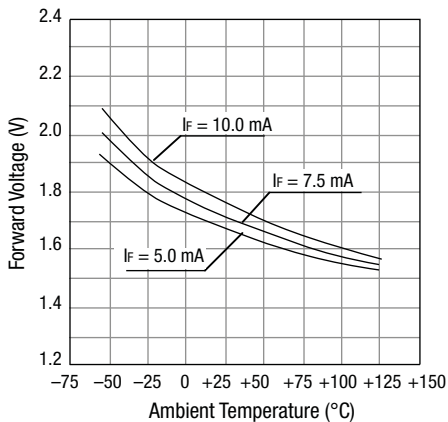

Figure 2. Input Diode Forward Voltage vs Temperature

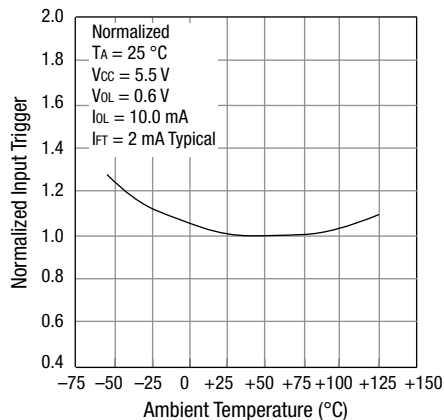

Figure 3. Normalized Input Trigger Current vs Temperature

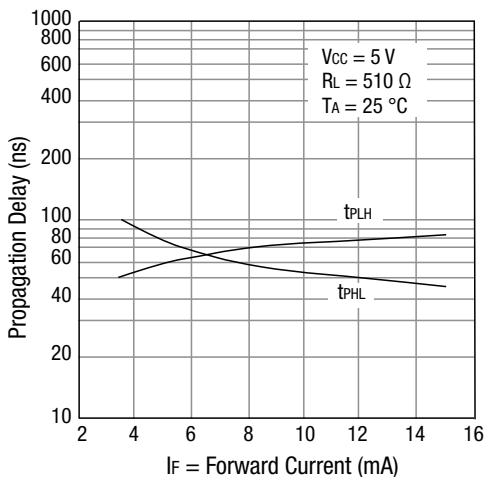

Figure 4. Propagation Delay vs Input Forward Current

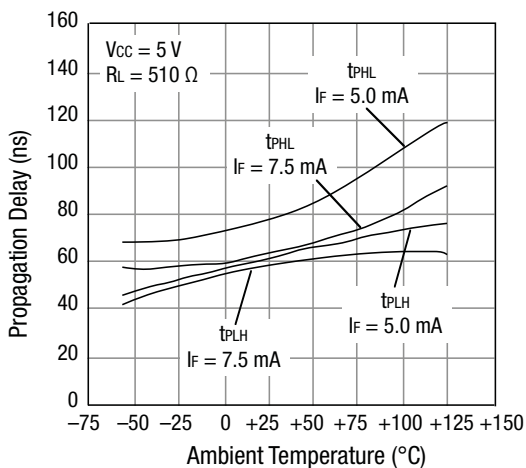

Figure 5. Propagation Delay vs Temperature

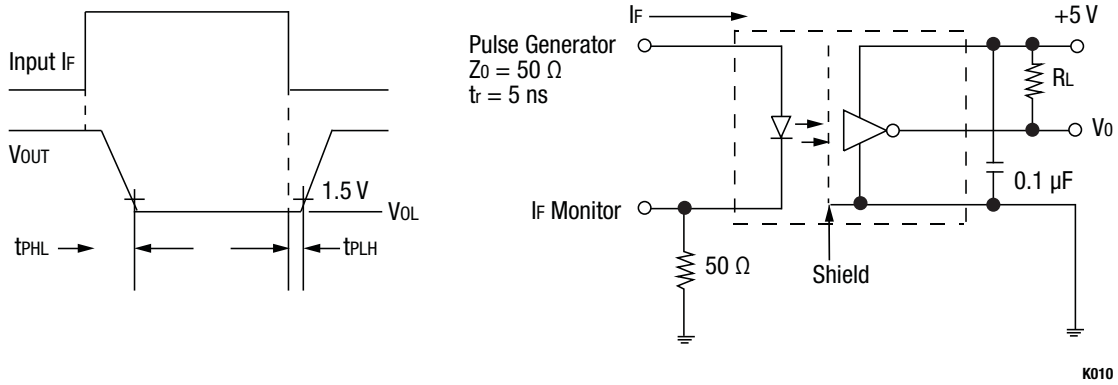

Figure 6. OLI500 Switching Test Circuit

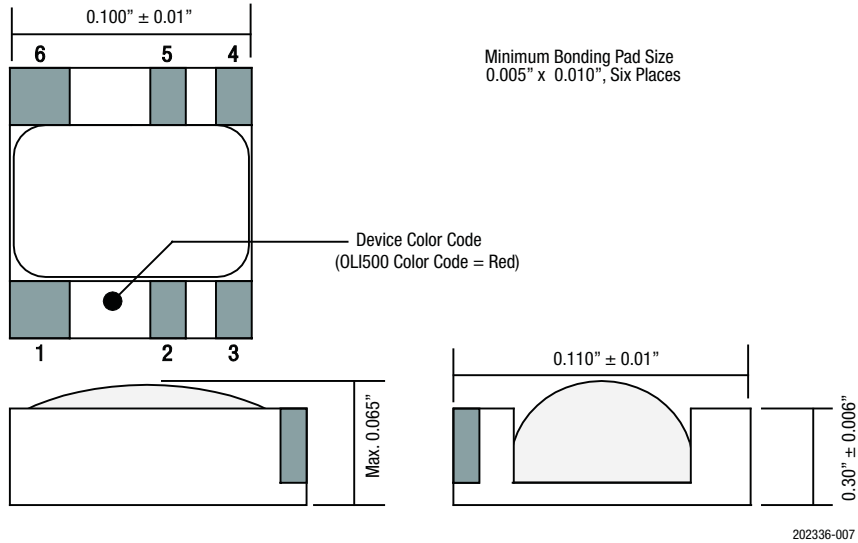

Figure 7. OLI500 Package Dimensions

Ordering Information

Model Name	Manufacturing Part Number
OLI500: High CMR, High-Speed Logic Gate Hermetic Optocoupler	OLI500

Copyright © 2012-2015, 2017 Isolink, Inc. All Rights Reserved.

Information in this document is provided in connection with Isolink, Inc. ("Isolink"), a wholly-owned subsidiary of Skyworks Solutions, Inc. These materials, including the information contained herein, are provided by Isolink as a service to its customers and may be used for informational purposes only by the customer. Isolink assumes no responsibility for errors or omissions in these materials or the information contained herein. Isolink may change its documentation, products, services, specifications or product descriptions at any time, without notice. Isolink makes no commitment to update the materials or information and shall have no responsibility whatsoever for conflicts, incompatibilities, or other difficulties arising from any future changes.

No license, whether express, implied, by estoppel or otherwise, is granted to any intellectual property rights by this document. Isolink assumes no liability for any materials, products or information provided hereunder, including the sale, distribution, reproduction or use of Isolink products, information or materials, except as may be provided in Isolink Terms and Conditions of Sale.

THE MATERIALS, PRODUCTS AND INFORMATION ARE PROVIDED "AS IS" WITHOUT WARRANTY OF ANY KIND, WHETHER EXPRESS, IMPLIED, STATUTORY, OR OTHERWISE, INCLUDING FITNESS FOR A PARTICULAR PURPOSE OR USE, MERCHANTABILITY, PERFORMANCE, QUALITY OR NON-INFRINGEMENT OF ANY INTELLECTUAL PROPERTY RIGHT; ALL SUCH WARRANTIES ARE HEREBY EXPRESSLY DISCLAIMED. ISOLINK DOES NOT WARRANT THE ACCURACY OR COMPLETENESS OF THE INFORMATION, TEXT, GRAPHICS OR OTHER ITEMS CONTAINED WITHIN THESE MATERIALS. ISOLINK SHALL NOT BE LIABLE FOR ANY DAMAGES, INCLUDING BUT NOT LIMITED TO ANY SPECIAL, INDIRECT, INCIDENTAL, STATUTORY, OR CONSEQUENTIAL DAMAGES, INCLUDING WITHOUT LIMITATION, LOST REVENUES OR LOST PROFITS THAT MAY RESULT FROM THE USE OF THE MATERIALS OR INFORMATION, WHETHER OR NOT THE RECIPIENT OF MATERIALS HAS BEEN ADVISED OF THE POSSIBILITY OF SUCH DAMAGE.

Customers are responsible for their products and applications using Isolink products, which may deviate from published specifications as a result of design defects, errors, or operation of products outside of published parameters or design specifications. Customers should include design and operating safeguards to minimize these and other risks. Isolink assumes no liability for applications assistance, customer product design, or damage to any equipment resulting from the use of Isolink products outside of stated published specifications or parameters.

Isolink is a trademark of Isolink Inc. in the United States and other countries. Skyworks and the Skyworks symbol are trademarks or registered trademarks of Skyworks Solutions, Inc., in the United States and other countries. Third-party brands and names are for identification purposes only, and are the property of their respective owners.

X-ON Electronics

Largest Supplier of Electrical and Electronic Components

Click to view similar products for [Transistor Output Optocouplers](#) category:

Click to view products by [Skyworks](#) manufacturer:

Other Similar products are found below :

[LTV-814S-TA](#) [LTV-824HS](#) [LTV-852S](#) [66095-001](#) [6N136-X017T](#) [MCT6-X007](#) [MOC8101-X017T](#) [PS2561A-1-W-A](#) [PS2561B-1-L-A](#)
[PS2561L-1-V-A](#) [MRF658](#) [IL755-1X007](#) [ILD74-X001](#) [ILQ615-2X017](#) [ILQ615-3X016](#) [LDA102S](#) [LDA110S](#) [PS2561-1-V-W-A](#) [PS2561AL-1-V-A](#) [PS2561L1-1-L-A](#) [PS2701A-1-F3-P-A](#) [PS2801-1-F3-P-A](#) [PS2911-1-L-AX](#) [CNY17-2X017](#) [CNY17-4X001](#) [CNY17-4X017](#) [CNY17F-1X007](#) [CNY17F-2X017](#) [CNY17F-4X001](#) [CNY17G-1](#) [LTV-214](#) [LTV-702VB](#) [LTV-733S](#) [LTV-816S-TA](#) [LTV-825S](#) [TCET1113](#) [TCET2100](#)
[4N25-X007T](#) [IL215AT](#) [ILD615-1X007](#) [ILQ2-X007](#) [VOS615A-2T](#) [WPPC-A11066AA](#) [WPPC-A11066AD](#) [WPPC-A11084ASS](#) [WPPC-A21068AA](#) [WPPC-D11066AA](#) [WPPC-D21068ED](#) [WPPC-D410616EA](#) [WPPC-D410616ED](#)