

DATA SHEET

OLS910: Hermetic Surface-Mount Photovoltaic Optocoupler

Features

- Performance guaranteed over -55 °C to +125 °C ambient temperature range
- 1500 V_{DC} electrical isolation
- High open-circuit voltage
- High short-circuit current
- Small hermetic surface mount package
- High reliability and rugged construction
- Isolated voltage source
- Offers 100% high reliability screenings

Description

The OLS910 consists of a pair of LEDs that are optically coupled to a dielectrically isolated photovoltaic diode array, packaged in a small hermetic Leadless Chip Carrier (LCC). When the LED is energized, the infrared emission is detected by the photovoltaic array and a DC output voltage is generated. This electrically isolated voltage can be used to drive the gates of Metal Oxide Semiconductor (MOS) devices.

Device mounting is achieved with reflow soldering or conductive epoxies.

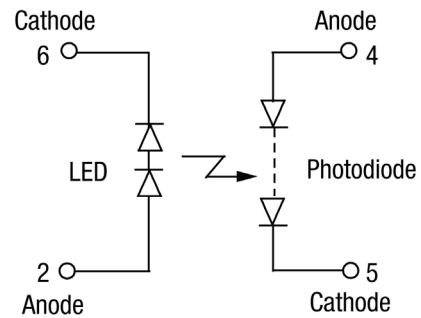

1, 3 = Do Not Connect

201346-001

Figure 1. OLS910 Block Diagram

Figure 1 shows the OLS910 functional block diagram. Table 1 provides the OLS910 absolute maximum ratings. Table 2 provides the OLS910 electrical specifications.

Figures 2 through 6 illustrate the OLS910 typical performance characteristics. Figure 7 shows the OLS910 package dimensions.

Table 1. OLS910 Absolute Maximum Ratings¹

Parameter	Symbol	Minimum	Maximum	Units
Coupled				
Input to output isolation voltage	V _{DC}	-1500	+1500	V
Storage temperature range	T _{STG}	-65	+150	°C
Operating temperature range	T _A	-55	+125	°C
Mounting temperature range (3 minutes maximum)			+240	°C
Input Diode				
Average input current	I _{DD}		50	mA
Peak forward current (≤1 ms duration)	I _F		100	mA
Reverse voltage	V _R		5	V
Power dissipation	P _D		100	mW
Output Detector				
Forward voltage	V _F		20	V
Reverse voltage	V _R		200	V

¹ Exposure to maximum rating conditions for extended periods may reduce device reliability. There is no damage to the device with only one parameter set at the limit and all other parameters set at or below their nominal value. Exceeding any of the limits listed here may result in permanent damage to the device.

CAUTION: Although this device is designed to be as robust as possible, electrostatic discharge (ESD) can damage this device. This device must be protected at all times from ESD. Static charges may easily produce potentials of several kilovolts on the human body or equipment, which can discharge without detection. Industry-standard ESD precautions should be used at all times.

Table 2. OLS910 Electrical Specifications¹
(T_A = -55 °C to +125 °C, Unless Otherwise Noted)

Parameter	Symbol	Test Condition	Minimum	Typical	Maximum	Units
Open circuit voltage	V _{OC}	I _F = 10.0 mA	7.5	13.0		V
Short circuit current	I _{SC}	I _F = 10 mA	-7	-20		μA
Input:						
Forward voltage	V _F	I _F = 10 mA, T _A = 25 °C I _F = +10 mA, T _A = -55 °C I _F = 10 mA, T _A = 125 °C	2.4 +2.8 2.2	2.8	3.2 +3.6 3.0	V V V
Reverse breakdown voltage	B _{VR}	I _R = 10 μA	5			V
Output leakage current ²	I _{L_O}	R _H ≤50%, 1500 V _{DC} , T _A = 25 °C, Duration = 1 s			1	μA
Time:						
Turn on	t _{ON}	I _F = 10 mA, PW = 100 μs, f = 1 kHz, C = 15 pf, T _A = 25 °C, R _L = 10 MΩ t _{ON} = 0 V to 90%		60		μs
Turn off	t _{OFF}	t _{OFF} = V _{OC} to 10%		400		μs

¹ Performance is guaranteed only under the conditions listed in the above table.

² Measured between pins 1, 2, and 6 shorted together, and pins 3, 4, and 5 shorted together. T_A = 25°C and duration = 1 s.

Typical Performance Characteristics

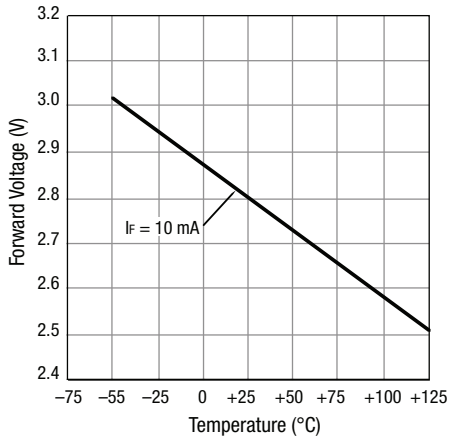

Figure 2. LED Forward Voltage vs Temperature

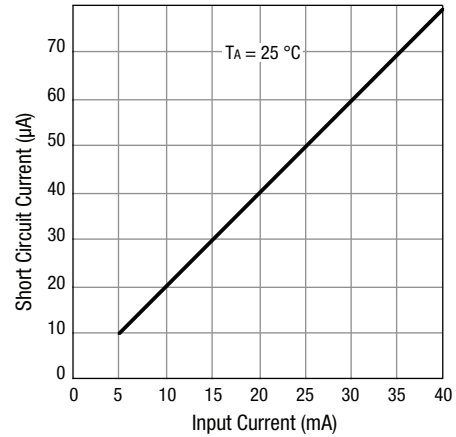

Figure 3. Short Circuit Current vs Input Current

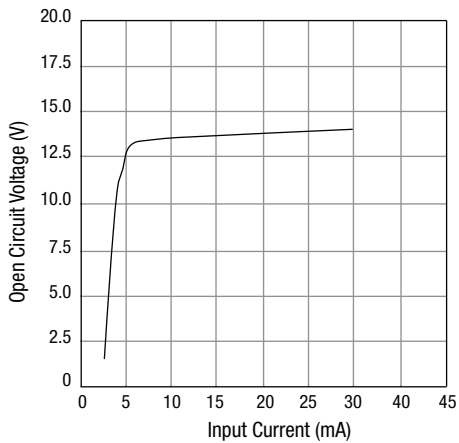

Figure 4. Open Circuit Voltage vs Input Current

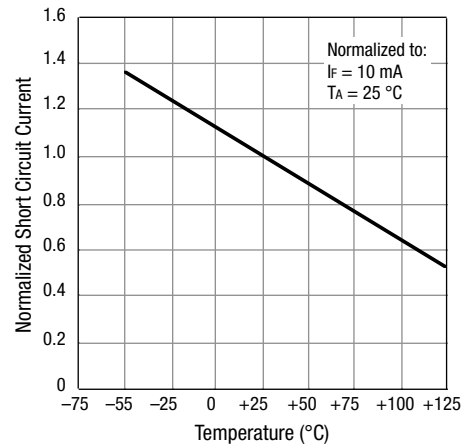

Figure 5. Normalized Short Circuit Current vs Temperature

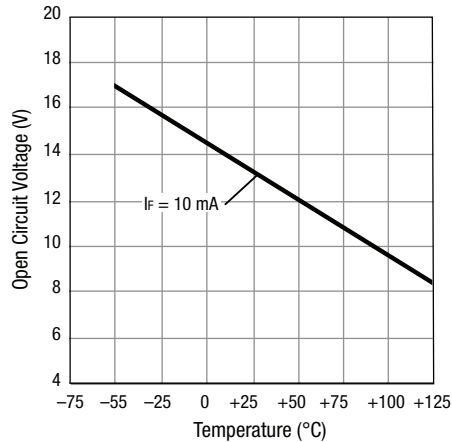
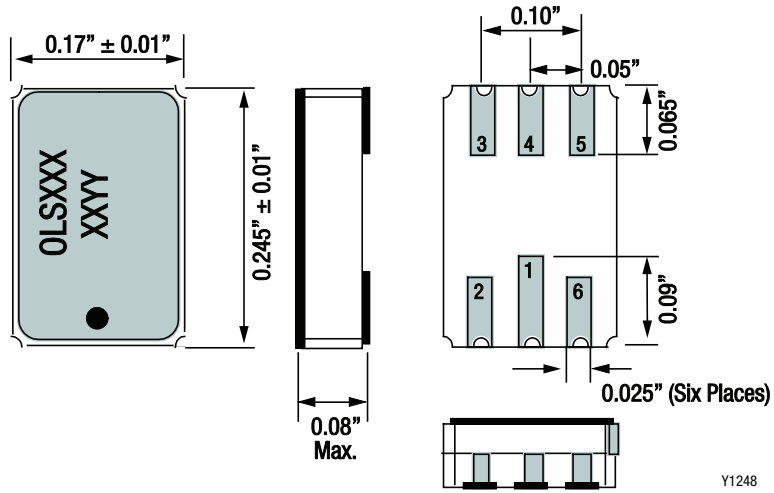

Figure 6. Open Circuit Voltage vs Temperature



Y1248

Figure 7. OLS910 Package Dimensions

Ordering Information

Part Number	Product Description
OLS910	Hermetic Surface Mount Photovoltaic Optocoupler

Copyright © 2012-2015, 2017, 2019 Isolink, Inc. All Rights Reserved.

Information in this document is provided in connection with Isolink, Inc. (“Isolink”), a wholly-owned subsidiary of Skyworks Solutions, Inc. These materials, including the information contained herein, are provided by Isolink as a service to its customers and may be used for informational purposes only by the customer. Isolink assumes no responsibility for errors or omissions in these materials or the information contained herein. Isolink may change its documentation, products, services, specifications or product descriptions at any time, without notice. Isolink makes no commitment to update the materials or information and shall have no responsibility whatsoever for conflicts, incompatibilities, or other difficulties arising from any future changes.

No license, whether express, implied, by estoppel or otherwise, is granted to any intellectual property rights by this document. Isolink assumes no liability for any materials, products or information provided hereunder, including the sale, distribution, reproduction or use of Isolink products, information or materials, except as may be provided in Skyworks Terms and Conditions of Sale.

THE MATERIALS, PRODUCTS AND INFORMATION ARE PROVIDED “AS IS” WITHOUT WARRANTY OF ANY KIND, WHETHER EXPRESS, IMPLIED, STATUTORY, OR OTHERWISE, INCLUDING FITNESS FOR A PARTICULAR PURPOSE OR USE, MERCHANTABILITY, PERFORMANCE, QUALITY OR NON-INFRINGEMENT OF ANY INTELLECTUAL PROPERTY RIGHT; ALL SUCH WARRANTIES ARE HEREBY EXPRESSLY DISCLAIMED. ISOLINK DOES NOT WARRANT THE ACCURACY OR COMPLETENESS OF THE INFORMATION, TEXT, GRAPHICS OR OTHER ITEMS CONTAINED WITHIN THESE MATERIALS. ISOLINK SHALL NOT BE LIABLE FOR ANY DAMAGES, INCLUDING BUT NOT LIMITED TO ANY SPECIAL, INDIRECT, INCIDENTAL, STATUTORY, OR CONSEQUENTIAL DAMAGES, INCLUDING WITHOUT LIMITATION, LOST REVENUES OR LOST PROFITS THAT MAY RESULT FROM THE USE OF THE MATERIALS OR INFORMATION, WHETHER OR NOT THE RECIPIENT OF MATERIALS HAS BEEN ADVISED OF THE POSSIBILITY OF SUCH DAMAGE.

Isolink products are not intended for use in medical, lifesaving or life-sustaining applications, or other equipment in which the failure of the Isolink products could lead to personal injury, death, physical or environmental damage. Isolink customers using or selling Isolink products for use in such applications do so at their own risk and agree to fully indemnify Isolink for any damages resulting from such improper use or sale.

Customers are responsible for their products and applications using Isolink products, which may deviate from published specifications as a result of design defects, errors, or operation of products outside of published parameters or design specifications. Customers should include design and operating safeguards to minimize these and other risks. Isolink assumes no liability for applications assistance, customer product design, or damage to any equipment resulting from the use of Isolink products outside of stated published specifications or parameters.

Isolink is a trademark of Isolink, Inc. in the United States and other countries. Skyworks and the Skyworks symbol are trademarks or registered trademarks of Skyworks Solutions, Inc. or its subsidiaries in the United States and other countries. Third-party brands and names are for identification purposes only, and are the property of their respective owners.

X-ON Electronics

Largest Supplier of Electrical and Electronic Components

Click to view similar products for [Skyworks](#) manufacturer:

Other Similar products are found below :

[RFX2401C-EVB](#) [SKY67101-396LF-EVB](#) [SKY65405-21-EVB](#) [SKY13377-313LF-EVB](#) [SKY13351-378LF-EVB](#) [CLA4606-085LF-EVB](#)
[CLA4603-085LF-EVB](#) [SKY12338-337LF-EVB](#) [SKY67150-396LF-EVB \(380-530 MHZ\)](#) [SKY67150-396LF-EVB \(650-1100 MHZ\)](#)
[SKY67153-396LF-EVB \(3400-3800 MHZ\)](#) [SKY67153-396LF-EVB \(700-1000 MHZ\)](#) [CLA4603-085-EVB](#) [AWB7227RM52P8](#) [SKY13414-](#)
[485LF-EVB](#) [SKY85314-11EK1](#) [SKY67159-396EK2](#) [SKY66423-11EK1](#) [SKY66188-11-EK1](#) [SKY66184-11-EVB](#) [SKY66181-11-EK1](#)
[SKY66005-11-EVB](#) [SKY66002-11-EVB](#) [SKY65981-11EK1](#) [SKY65805-696EK1](#) [SKY65017-70LF-EVB](#) [SKY13373-460LF-EVB](#)
[SKY13355-374LF-EVB](#) [SE5516A-EK1](#) [SE5023L-EK1](#) [SE2436L-EK1](#) [SKY13575-639-EVB](#) [SKY12211-478LF-EVB](#) [SKY65111-348LF-](#)
[EVB](#) [SE5003L1-R-EK1](#) [SKY67151-396EK3](#) [SKY13372-467LF-EVB](#) [SKY85302-11EK1](#) [SKY85803-11EK1](#) [SKY65405-21EK1](#) [MAFX-](#)
[000015-RL00FR](#) [SKY65162-70EK4](#) [SKYA21043EK1](#) [SKY13698-694EK1](#) [SKY85735-11EK1](#) [SKY67189-396EK1](#) [RFX2411N-EVB](#)
[AS179-92LF](#) [AS169-73LF-EVB](#) [SMP1330-085-EVB](#)