



DATA SHEET

SE2568U: 2.4 GHz High Efficiency Wireless LAN PA

Applications

- IEEE802.11b DSSS WLAN
- IEEE802.11g/n OFDM WLAN
- General applications

Features

- Dual mode IEEE802.11b & IEEE802.11g
- Integrated PA, digital bias control, 50 Ω input and output match, 3.2 GHz TX filter
- Integrated harmonic filter
- Integrated load insensitive power detector, with < 1 dB error at 2 : 1 mismatch
- 20 dBm, 802.11b, 11 Mbps, ACPR < -30 dBc, 3.3 V
- 18 dBm, 802.11g, @ 3.0 % EVM, 54 Mbps, 3.3 V
- 20.5 dBm, 802.11g @ 3.0 % EVM, 54 Mbps, 5.0 V
- Lead free, halogen free, ROHS compliant QFN (8-pin, 2 × 2 × 0.5 mm) package (MSL1, 260 °C per JEDEC J-STD-020)



Skyworks Green™ products are compliant with all applicable legislation and are halogen-free. For additional information, refer to *Skyworks Definition of Green™*, document number SQ04-0074.

Description

The SE2568U is a complete 802.11 b/g WLAN discrete power amplifier. The device provides all the functionality of the power amplifier, power detector, filter, associated input, inter-stage and output matching in an ultra-compact 2 mm × 2 mm × 0.5 mm form factor.

The SE2568U is designed for ease of use, with all the critical input and output matching integrated. The SE2568U includes a transmitter power detector with 20 dB of dynamic range and a digital Enable for power on/off control. Harmonic filters and an input 3.2 GHz LO rejection filter are integrated on-chip. The power ramp rise/fall time is 0.7 μs typical.

The device package and pinout for the 8-pin QFN are shown in Figure 1. A block diagram of the SE2568U is shown in Figure 2.

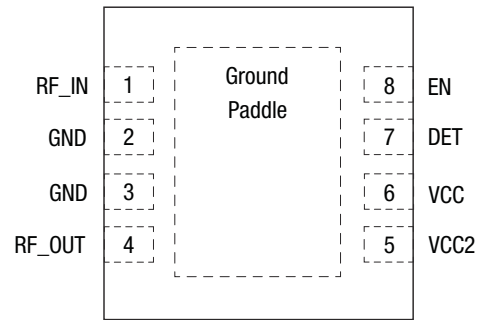

ts001

Figure 1. SE2568U Pinout – 8-Pin QFN (Top View)

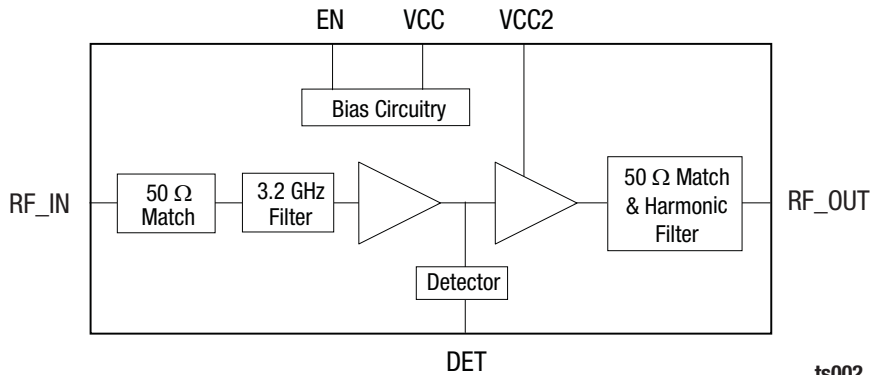

ts002

Figure 2. SE2568U Block Diagram

Electrical and Mechanical Specifications

Signal pin assignments and functional pin descriptions are described in Table 1. The absolute maximum ratings of the

SE2568U are provided in Table 2. Recommended operating conditions are specified in Table 3. Electrical specifications are provided in Tables 4 through 6, and Figure 3.

Table 1. SE2568U Signal Descriptions

Pin	Name	Description
1	RF_IN	RF input (no DC voltage on the pin, but DC short to ground)
2	GND	Ground
3	GND	Ground
4	RF_OUT	RF output (no DC voltage on the pin, DC open to ground)
5	VCC2	Final stage supply voltage (may attach directly to battery)
6	VCC	First stage supply voltage (may attach directly to battery)
7	DET	Power detector output
8	EN	Power amplifier enable
Die paddle	GND	Ground

Table 2. SE2568U Absolute Maximum Ratings (Note 1)

Parameter	Symbol	Minimum	Maximum	Units
Supply voltage on VCC	VCC	-0.3	+5.5	V
DC input on EN	EN	-0.3	+4.0	V
RF input power. ANT terminated in 50 Ω match	TX		12.0	dBm
Operating temperature range	TA	-40	+85	°C
Storage temperature range	TSTG	-40	+150	°C
Electrostatic discharge: Human Body Model (HBM), Class 1B	ESD		500	V

Note 1: Exposure to maximum rating conditions for extended periods may reduce device reliability. There is no damage to device with only one parameter set at the limit and all other parameters set at or below their nominal value. Exceeding any of the limits listed here may result in permanent damage to the device.

CAUTION: Although this device is designed to be as robust as possible, Electrostatic Discharge (ESD) can damage this device. This device must be protected at all times from ESD. Static charges may easily produce potentials of several kilovolts on the human body or equipment, which can discharge without detection. Industry-standard ESD precautions should be used at all times.

Table 3. SE2568U Recommended Operating Conditions

Parameter	Symbol	Minimum	Typical	Maximum	Units
Ambient temperature	TA	-40	25	85	°C
Supply voltage, nominal operation	Vcc	3.0	3.3	5.0	V
Supply voltage, output power reduced by 2 dB typ.		2.3	3.0		V

Table 4. SE2568U Electrical Specifications: DC Characteristics (Note 1)

(Vcc = 3.3 V (default) or Vcc = 5.0 V (as noted), EN = 3.3 V, TA = +25 °C as Measured on the SE2568U-EK1 Evaluation Board, All Unused Ports Terminated with 50 Ω, Unless Otherwise Noted)

Parameter	Symbol	Test Condition	Min	Typ	Max	Units
Total supply current	ICC_G	54 Mbps OFDM signal, 64QAM 18 dBm, Vcc = 3.3 V 20.5 dBm, Vcc = 5.0 V		135 150		mA
Total supply current	ICC_N	802.11n, MCS7 17 dBm, Vcc = 3.3 V 19 dBm, Vcc = 5.0 V		115 130		mA
Total supply current	ICC_B	11 Mbps CCK signal, BT = 0.45 20 dBm, Vcc = 3.3 V 22 dBm, Vcc = 5.0 V		160 175		mA
Total supply current	ICQ	No RF. Vcc = 3.3 V Vcc = 5.0 V		90 100		mA
Total supply current	ICC_OFF	EN = 0 V, no RF applied		1	10	μA

Note 1: Performance is guaranteed only under the conditions listed in this table.

Table 5. SE2568U Electrical Specifications: AC Characteristics (802.11g/n Transmit) (Note 1)

(Vcc = 3.3 V (default) or Vcc = 5.0 V (as noted), EN = 3.3 V, TA = +25 °C as Measured on the SE2568U-EK1 Evaluation Board, All Unused Ports Terminated with 50 Ω, Unless Otherwise Noted)

Parameter	Symbol	Test Condition	Min	Typ	Max	Units
Frequency range	f _{IN}		2400		2500	MHz
Output power, 3.3 V	P _{OUT}	54 Mbps OFDM, 64 QAM, EVM = 3%		18		dBm
		11 Mbps CCK, BT = 0.45, Mask		20		dBm
		802.11n, HT20, all data rates, Mask		22		dBm
		802.11n, HT40, all data rates, Mask		20		dBm
Output power, 5.0 V	P _{OUT}	54 Mbps OFDM, 64 QAM, EVM = 3%		20.5		dBm
		11 Mbps CCK, BT = 0.45, Mask		22		dBm
		802.11n, HT20, all data rates, Mask		24		dBm
		802.11n, HT40, all data rates, Mask		22		dBm
1 dB output compression point	P _{1DB}	Vcc = 3.3 V		25.0		dBm
Small signal gain	IS ₂₁		25	28	29	dB
Small signal gain variation	ΔS ₂₁	Gain variation over single 20 MHz channel		0.5		dB
		Gain variation over band			1.1	dB
Gain @ limit at Ref-VCO spur frequency	S _{21,3,2}	3206 to 3312 MHz			15	dB
2 nd harmonics	2f _o	1 Mbps, BPSK, 20 dBm, 3.3 V, 22 dBm, 5.0 V		-50	-45	dBm/MHz
3 rd harmonics	3f _o	1 Mbps, BPSK, 20 dBm, 3.3 V, 22 dBm, 5.0 V		-50 -48	-45 -43	dBm/MHz dBm/MHz
Delay and rise/fall time	t _R , t _F	50 % of V _{EN} edge and 90/10 % of final output power level		0.7		μs
Input return loss	IS ₁₁		7	10		dB
Stability	STAB	CW, P _{OUT} = 20 dBm, Vcc = 3.3 V, 0.1 GHz ~ 2 GHz, load VSWR = 10:1	All non-harmonically related outputs less than -42 dBm/MHz			
Ruggedness	R _u	P _{IN} = 12 dBm, Vcc = 3.3 V, Load VSWR = 10:1	No permanent damage			

Note 1: Performance is guaranteed only under the conditions listed in this table.

Table 6. SE2568U Electrical Specifications: Power Detector Characteristics (Note 1)

(V_{CC} = 3.3 V, EN = 3.3 V, T_A = +25 °C as Measured on the SE2568U-EK1 evaluation board, all unused ports terminated with 50 Ω, Unless Otherwise Noted)

Parameter	Symbol	Test Condition	V _{CC} = 3.3 V			V _{CC} = 5.0 V			Units
			Min	Typ	Max	Min	Typ	Max	
Frequency range	f _{OUT}		2400		2500	2400		2500	MHz
Power detect range, CW	PDR	Measured at ANT	0		23	0		23	dBm
DC source impedance on PD_OUT	PDZSRC			1			1		kΩ
Output voltage, P _{OUT} = No RF	PDV _{NORF}	Measured into 1 MΩ		0.12			0.12		V
Output voltage, P _{OUT} = 18 dBm CW	PDV _{P18}	Measured into 1 MΩ		0.60			0.55		V
Output voltage, P _{OUT} = 20 dBm CW	PDV _{P20}	Measured into 1 MΩ		0.75			0.70		V
Output voltage, P _{OUT} = 23 dBm CW	PDV _{P23}	Measured into 1 MΩ		NA			1.00		V
Power detect low-pass filter -3dB corner frequency	LPF-3dB	Measured into 1 MΩ	260	290	400	270	290	400	kHz

Note 1: Performance is guaranteed only under the conditions listed in this table.

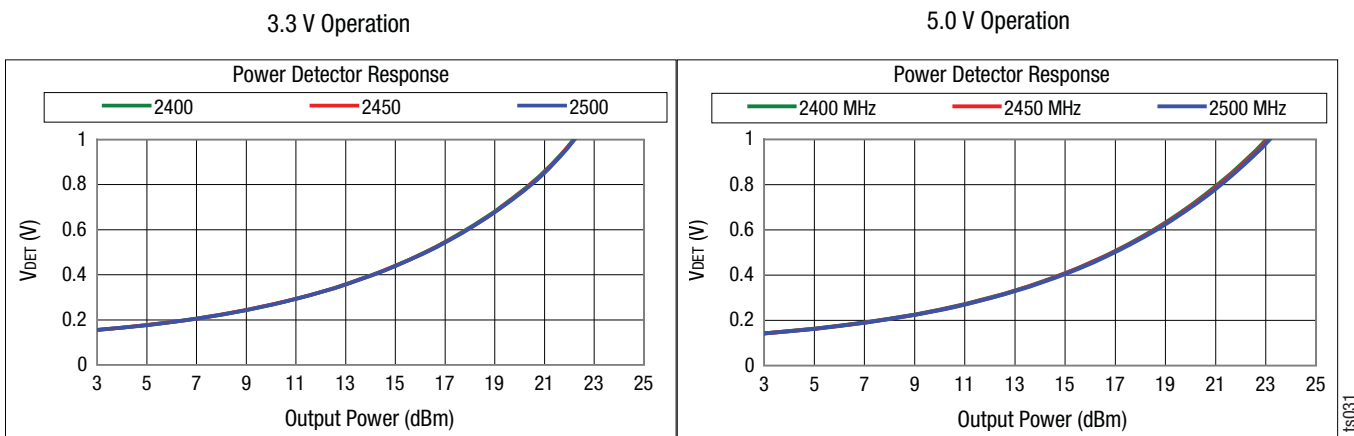

Figure 3. SE2568U Power Detector Characteristics

Package Dimensions

The PCB layout footprint for the SE2568U is provided in Figure 4. Typical case markings are shown in Figure 5. Package dimensions for the 8-pin QFN are shown in Figure 6, and carrier tape dimensions are provided in Figure 7.

Package and Handling Information

Instructions on the shipping container label regarding exposure to moisture after the container seal is broken must be followed. Otherwise, problems related to moisture absorption may occur when the part is subjected to high temperature during solder assembly.

The SE2568U is rated to Moisture Sensitivity Level 1 (MSL1) at 260 °C. It can be used for lead or lead-free soldering. For additional information, refer to the Skyworks Application Note, *Solder Reflow Information*, document number 200164.

Care must be taken when attaching this product, whether it is done manually or in a production solder reflow environment. If the part is manually attached, precaution should be taken to insure that the device is not subjected to temperatures above its rated peak temperature for an extended period of time. For details on both attachment techniques, precautions, and handling procedures recommended by Skyworks, please refer to:

- Skyworks Application Note: *QFN Solder Reflow and Rework Information Application Note*, Document Number QAD-00045.
- Skyworks Application Note: *Handling, Packing, Shipping and Use of Moisture Sensitive QFN Application Note*, Document Number QAD-00044.

Production quantities of this product are shipped in a standard tape and reel format.

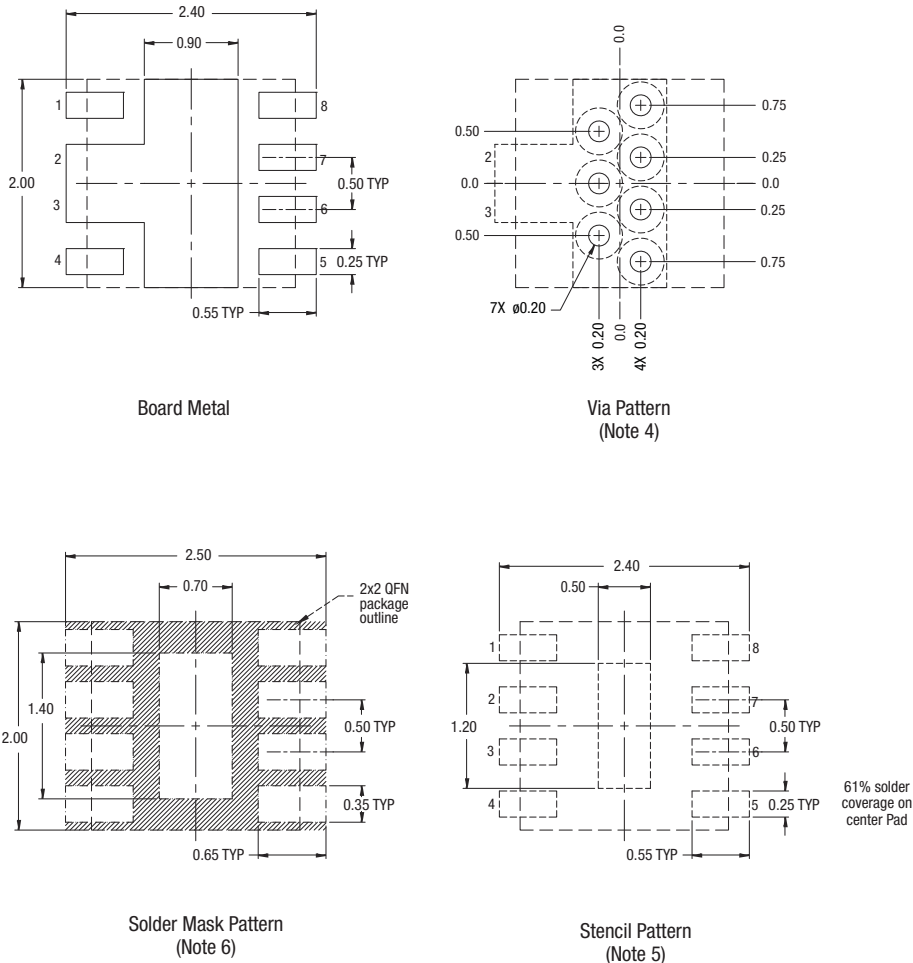

- Notes:
1. All dimensions are in millimeters.
 2. Dimensions and tolerances per ASME Y14.5M-1994.
 3. Unless specified, dimensions are symmetrical about center lines.
 4. Via hole recommendations: 0.025 mm Cu via wall plating (minimum). Via holes to be filled with conductive paste and plated over.
 5. Stencil recommendations: 0.125 mm stencil thickness., laser cut apertures, trapezoidal walls and rounded corners offer better paste release.
 6. Solder mask recommendations: contact board fabricator for recommended solder mask offset and tolerance.

ts034

Figure 6. PCB Layout Footprint for the SE2568U

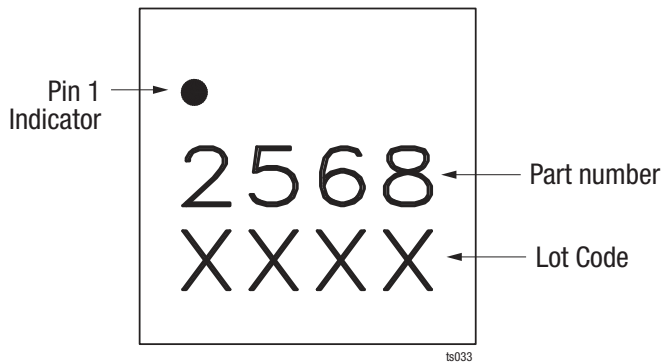
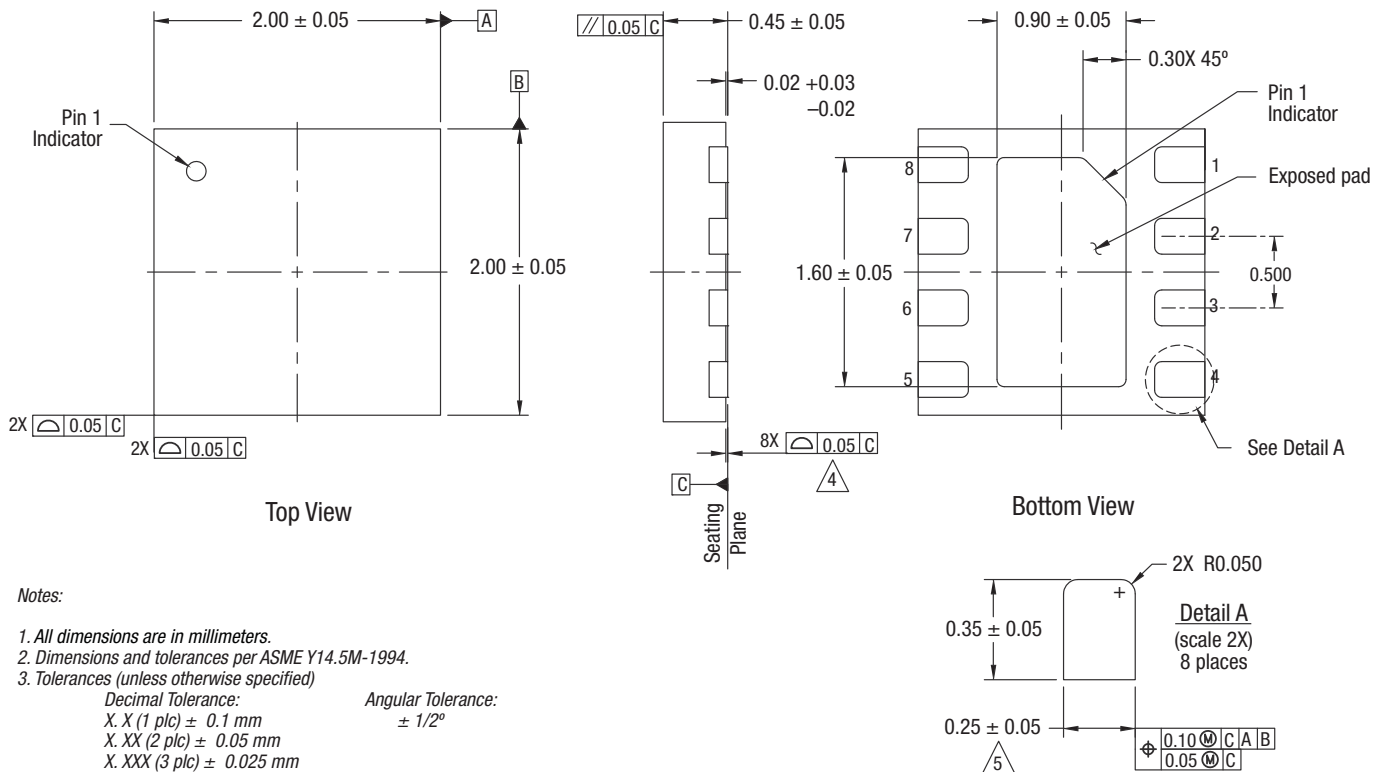

Figure 7. Typical Case Markings (Top View)



Notes:

1. All dimensions are in millimeters.
2. Dimensions and tolerances per ASME Y14.5M-1994.
3. Tolerances (unless otherwise specified)

Decimal Tolerance:	Angular Tolerance:
X.X (1 plc) ± 0.1 mm	± 1/2°
X.XX (2 plc) ± 0.05 mm	
X.XXX (3 plc) ± 0.025 mm	
4. Coplanarity applies to the terminal as well as all other bottom surface metallization.
5. Dimension applies to metallized terminal. If terminal tip has a radius, dimension should not be measured in that radius area.
6. Plating requirements per source control drawing (SCD) 2504.
7. Unless otherwise specified, dimensions are symmetrical about center lines.

ts032

Figure 8. SE2568U 8-Pin QFN Package Dimensions

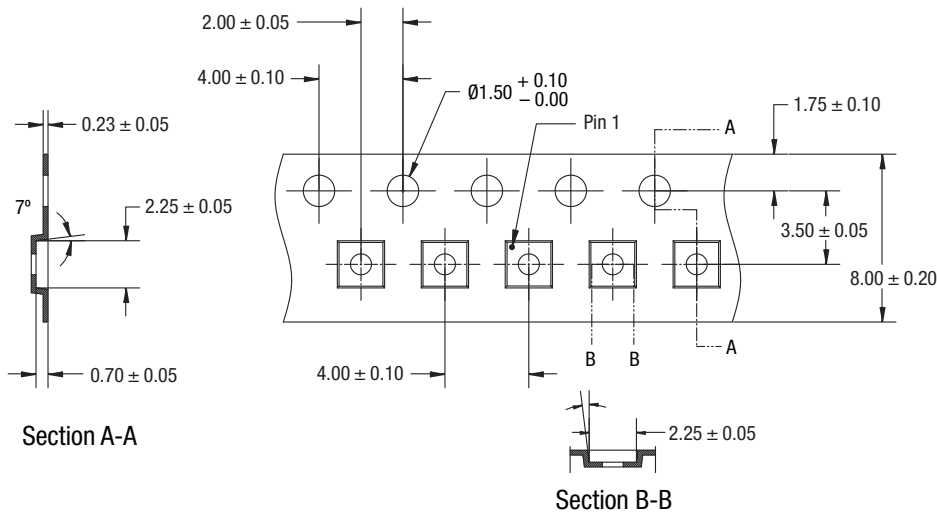

All measurements are in millimeters unless otherwise stated.

ts035

Figure 9. SE2568U 8-Pin QFN Carrier Tape Dimensions

Ordering Information

Model Name	Manufacturing Part Number	Evaluation Board Part Number
SE2568U: 2.4 GHz high efficiency wireless LAN PA	SE2568U	SE2568U-EK1

Copyright © 2012-2014 Skyworks Solutions, Inc. All Rights Reserved.

Information in this document is provided in connection with Skyworks Solutions, Inc. (“Skyworks”) products or services. These materials, including the information contained herein, are provided by Skyworks as a service to its customers and may be used for informational purposes only by the customer. Skyworks assumes no responsibility for errors or omissions in these materials or the information contained herein. Skyworks may change its documentation, products, services, specifications or product descriptions at any time, without notice. Skyworks makes no commitment to update the materials or information and shall have no responsibility whatsoever for conflicts, incompatibilities, or other difficulties arising from any future changes.

No license, whether express, implied, by estoppel or otherwise, is granted to any intellectual property rights by this document. Skyworks assumes no liability for any materials, products or information provided hereunder, including the sale, distribution, reproduction or use of Skyworks products, information or materials, except as may be provided in Skyworks Terms and Conditions of Sale.

THE MATERIALS, PRODUCTS AND INFORMATION ARE PROVIDED “AS IS” WITHOUT WARRANTY OF ANY KIND, WHETHER EXPRESS, IMPLIED, STATUTORY, OR OTHERWISE, INCLUDING FITNESS FOR A PARTICULAR PURPOSE OR USE, MERCHANTABILITY, PERFORMANCE, QUALITY OR NON-INFRINGEMENT OF ANY INTELLECTUAL PROPERTY RIGHT; ALL SUCH WARRANTIES ARE HEREBY EXPRESSLY DISCLAIMED. SKYWORKS DOES NOT WARRANT THE ACCURACY OR COMPLETENESS OF THE INFORMATION, TEXT, GRAPHICS OR OTHER ITEMS CONTAINED WITHIN THESE MATERIALS. SKYWORKS SHALL NOT BE LIABLE FOR ANY DAMAGES, INCLUDING BUT NOT LIMITED TO ANY SPECIAL, INDIRECT, INCIDENTAL, STATUTORY, OR CONSEQUENTIAL DAMAGES, INCLUDING WITHOUT LIMITATION, LOST REVENUES OR LOST PROFITS THAT MAY RESULT FROM THE USE OF THE MATERIALS OR INFORMATION, WHETHER OR NOT THE RECIPIENT OF MATERIALS HAS BEEN ADVISED OF THE POSSIBILITY OF SUCH DAMAGE.

Skyworks products are not intended for use in medical, lifesaving or life-sustaining applications, or other equipment in which the failure of the Skyworks products could lead to personal injury, death, physical or environmental damage. Skyworks customers using or selling Skyworks products for use in such applications do so at their own risk and agree to fully indemnify Skyworks for any damages resulting from such improper use or sale.

Customers are responsible for their products and applications using Skyworks products, which may deviate from published specifications as a result of design defects, errors, or operation of products outside of published parameters or design specifications. Customers should include design and operating safeguards to minimize these and other risks. Skyworks assumes no liability for applications assistance, customer product design, or damage to any equipment resulting from the use of Skyworks products outside of stated published specifications or parameters.

Skyworks, the Skyworks symbol, and “Breakthrough Simplicity” are trademarks or registered trademarks of Skyworks Solutions, Inc., in the United States and other countries. Third-party brands and names are for identification purposes only, and are the property of their respective owners. Additional information, including relevant terms and conditions, posted at www.skyworksinc.com, are incorporated by reference.

X-ON Electronics

Largest Supplier of Electrical and Electronic Components

Click to view similar products for [RF Development Tools](#) category:

Click to view products by [Skyworks](#) manufacturer:

Other Similar products are found below :

[MAAM-011117](#) [MAAP-015036-DIEEV2](#) [EV1HMC1113LP5](#) [EV1HMC6146BLC5A](#) [EV1HMC637ALP5](#) [EVAL-ADG919EBZ](#) [ADL5363-EVALZ](#) [LMV228SDEVAL](#) [SKYA21001-EVB](#) [SMP1331-085-EVB](#) [EV1HMC618ALP3](#) [EVAL01-HMC1041LC4](#) [MAAL-011111-000SMB](#)
[MAAM-009633-001SMB](#) [107712-HMC369LP3](#) [107780-HMC322ALP4](#) [SP000416870](#) [EV1HMC470ALP3](#) [EV1HMC520ALC4](#)
[EV1HMC244AG16](#) [MAX2614EVKIT#](#) [124694-HMC742ALP5](#) [SC20ASATEA-8GB-STD](#) [MAX2837EVKIT+](#) [MAX2612EVKIT#](#)
[MAX2692EVKIT#](#) [EV1HMC629ALP4E](#) [SKY12343-364LF-EVB](#) [108703-HMC452QS16G](#) [EV1HMC863ALC4](#) [EV1HMC427ALP3E](#)
[119197-HMC658LP2](#) [EV1HMC647ALP6](#) [ADL5725-EVALZ](#) [106815-HMC441LM1](#) [EV1HMC1018ALP4](#) [UXN14M9PE](#) [MAX2016EVKIT](#)
[EV1HMC939ALP4](#) [MAX2410EVKIT](#) [MAX2204EVKIT+](#) [EV1HMC8073LP3D](#) [SIMSA868-DKL](#) [SIMSA868C-DKL](#) [SKY65806-636EK1](#)
[SKY68020-11EK1](#) [SKY67159-396EK1](#) [SKY66181-11-EK1](#) [SKY65804-696EK1](#) [SKY13396-397LF-EVB](#)