

DATA SHEET
SE2595L: Dual-Band 802.11n Wireless LAN Front-End
Preliminary Information

Applications

- 802.11n, MIMO solutions
- IEEE802.11b DSSS WLAN
- IEEE802.11g OFDM WLAN
- IEEE802.11a OFDM WLAN
- Access Points, PCMCIA, PC cards

Features

- 1 Transmit and 1 receive path architecture for use as MIMO building block.
- All RF ports matched to 50 Ω
- Integrated 2.4/5 GHz PA, 2.4/5 GHz LNA, TX Filter, T/R switches and diplexers
- Integrated Power Detector
- 19 dBm O/P Power, 802.11b, 11 Mbits, ACPR = 32 dBc
- 18 dBm @ 3.0 % EVM, 802.11g, 54 Mbits
- 16 dBm @ 3.0 % EVM, 802.11a, 54 Mbits
- Single supply voltage: 3.3 V \pm 10 %
- Lead free, Halogen Free and RoHS compliant
- Thin lead free plated package, 4 mm x 6 mm x 0.9 mm, MSL 1

Product Description

The SE2595L is a complete 802.11n WLAN RF front-end module providing all the functionality of the power amplifiers, LNA, power detector, T/R switch, diplexers and associated matching. The SE2595L provides a complete 2.4 GHz and 5 GHz WLAN Multiple Input, Multiple Output (MIMO) RF solution from the output of the transceiver to the antennas in a compact form factor.

The receive path is designed to maximize performance by providing both a low noise amplifier as well as a bypass state, for use when high power signals are being received.

Designed for ease of use, all RF ports are matched to 50 Ω to simplify PCB layout and the interface to the transceiver RFIC. The SE2595L also includes a transmitter power detector for each band with 20 dB of dynamic range. The power ramp rise/fall time is less than 0.5 μ s.

The device also provides band pass filters for both the a and b/g bands prior to the input of each 2.4 GHz and 5 GHz power amplifiers, respectively.

Ordering Information

Part No.	Package	Remark
SE2595L	32 pin QFN	Samples
SE2595L-R	32 pin QFN	Tape & Reel
SE2595L-EK1	N/A	Evaluation kit

DATA SHEET
SE2595L: Dual-Band 802.11n Wireless LAN Front-End
Preliminary Information

Functional Block Diagram

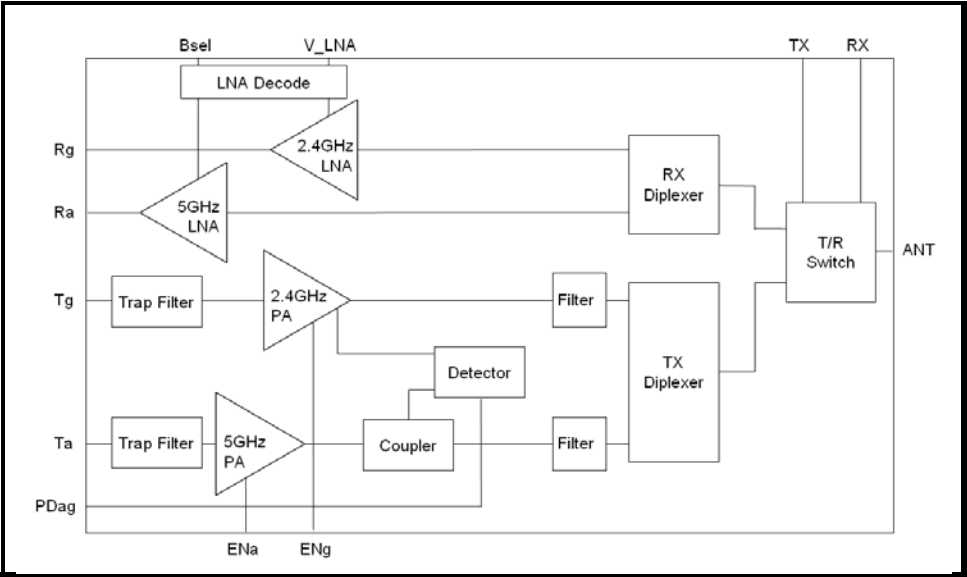

Figure 1: Functional Block Diagram

DATA SHEET
SE2595L: Dual-Band 802.11n Wireless LAN Front-End
Preliminary Information

Pin Out Diagram

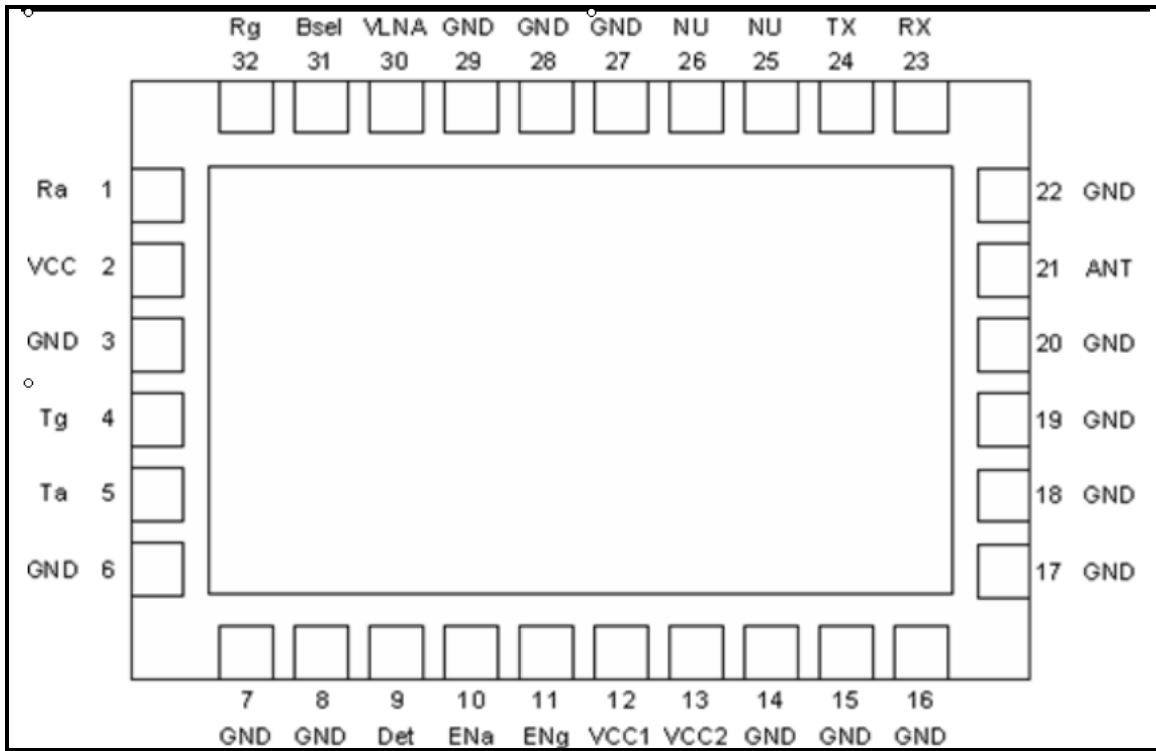

Figure 2: SE2595L Pin Out (Top View Through Package)

Pin Out Description

Pin No.	Name	Description
1	Ra	5 GHz Receive Output
2	VCC	Supply Voltage, LNA
3	GND	Ground
4	Tg	2.4 GHz Transmit Input
5	Ta	5 GHz Transmit Input
6	GND	Ground
7	GND	Ground
8	GND	Ground
9	Det	Power Detector, 2.5 & 5 GHz
10	ENa	5 GHz PA Enable
11	ENg	2.4 GHz PA Enable
12	VCC1	Supply Voltage, Driver Stage
13	VCC2	Supply Voltage, Power Stage

Pin No.	Name	Description
14	GND	Ground
15	GND	Ground
16	GND	Ground
17	GND	Ground
18	GND	Ground
19	GND	Ground
20	GND	Ground
21	ANT	Antenna
22	GND	Ground
23	RX	Rx Switch Select
24	TX	Tx Switch Select
25	NU	Not Used
26	NU	Not Used

DATA SHEET
SE2595L: Dual-Band 802.11n Wireless LAN Front-End
Preliminary Information

Pin No.	Name	Description	Pin No.	Name	Description
27	GND	Ground	30	V_LNA	LNA Enable
28	GND	Ground	31	Bsel	LNA Band Select
29	GND	Ground	32	Rg	2.4 GHz Receive Output

Absolute Maximum Ratings

These are stress ratings only. Exposure to stresses beyond these maximum ratings may cause permanent damage to, or affect the reliability of the device. Avoid operating the device outside the recommended operating conditions defined below. This device is ESD sensitive. Handling and assembly of this device should be at ESD protected workstations.

Symbol	Definition	Min.	Max.	Unit
V _{CC}	Supply Voltage	-0.3	4.2	V
PU	ENg, ENa, V_LNA, Bsel	-0.3	4.0	V
TX _{RF}	Ta, Tg, ANT terminated into 50Ω match	-	10.0	dBm
T _A	Operating Temperature Range	-40	85	°C
T _{STG}	Storage Temperature Range	-40	150	°C
ESD _{HBM}	JEDEC JESD22-A114 all pins	150	-	V

Recommended Operating Conditions

Symbol	Parameter	Min.	Typ.	Max.	Unit
V _{CC}	Supply Voltage	3.0	3.3	3.6	V
T _A	Ambient Temperature	-40	25	85	°C

DC Electrical Characteristics

Conditions: V_{CC} = 3.3 V, T_A = 25 °C, as measured on Skyworks Solutions' SE2595L-EV1 evaluation board (de-embedded to device), all unused ports terminated with 50 ohms, unless otherwise noted

Symbol	Parameter	Conditions	Min.	Typ.	Max.	Unit
TX _{ICC-G}	Total 802.11g Transmit Supply Current	P _{OUT} = 17 dBm, 54 Mbps OFDM signal, 64QAM, ENg = 3.3 V, ENa = 0 V, TX = 3.3 V, RX = 0 V	-	180	-	mA
TX _{ICQ-G}	Quiescent current , 802.11g Transmit supply Current	No RF applied ENg = 3.3 V, ENa = 0 V, TX = 3.3V, RX = 0 V	-	110	-	mA
TX _{ICC-A}	Total 802.11a Transmit Supply Current	P _{OUT} = 17 dBm, 54 Mbps OFDM signal, 64QAM, ENa = 3.3 V, ENg = 0 V, TX = 3.3 V, RX = 0 V	-	230	-	mA

DATA SHEET
SE2595L: Dual-Band 802.11n Wireless LAN Front-End
Preliminary Information

Symbol	Parameter	Conditions	Min.	Typ.	Max.	Unit
TxI _{Cq-A}	Quiescent current , 802.11a Transmit supply Current	No RF applied ENa = 3.3V, ENg = 0V, TX = 3.3V, RX = 0V	-	155	-	mA
RxI _{CC-G}	Total 802.11b/g Receive Supply Current	V_LNA = 3.3 V, Bsel = 3.3 V, RX = 3.3 V, TX = 0 V	-	8.5	15	mA
RxI _{CC-a}	Total 802.11a Receive Supply Current	V_LNA = 3.3 V, Bsel = 0 V, RX = 3.3 V, TX = 0 V	-	8.5	15	mA
I _{CC-OFF}	Total Supply Current	No RF, ENg = ENa = 0 V, V_LNA = 0 V, TX = RX = 0 V	-	2	100	μA

Transmit Power Amplifier Logic Characteristics

Conditions: V_{CC} = 3.3 V, T_A = 25 °C, as measured on Skyworks Solutions' SE2595L-EV1 evaluation board (de-embedded to device), all unused ports terminated with 50 ohms, unless otherwise noted.

Symbol	Parameter	Conditions	Min.	Typ.	Max.	Unit
V _{ENH}	Logic High Voltage for ENg, ENa (Module On)	-	-	2.0	V _{CC}	V
V _{ENL}	Logic Low Voltage ENg, ENa (Module Off)	-	0	0.5	-	V
I _{ENH}	Input Current Logic High Voltage (ENg, ENa)	-	-	100	150	μA
I _{ENL}	Input Current Logic Low Voltage (ENg, ENa)	-	-	0.2	-	μA

Receive LNA Logic Characteristics

Conditions: V_{CC} = 3.3 V, T_A = 25 °C, as measured on Skyworks Solutions' SE2595L-EV1 evaluation board (de-embedded to device), all unused ports terminated with 50 ohms, unless otherwise noted.

Symbol	Parameter	Conditions	Min.	Typ.	Max.	Unit
V _{RENH}	Logic High Voltage for V_LNA, Bsel (Module On)	-	-	3.2	V _{CC}	V
V _{RENL}	Logic Low for V_LNA, Bsel (Module Off)	-	-0.5	0.3	-	V
I _{RENH}	Input Current Logic High Voltage (V_LNA, Bsel)	-	-	-	400	μA
I _{RENL}	Input Current Logic Low Voltage (V_LNA, Bsel)	-	-	0	-	μA

DATA SHEET
SE2595L: Dual-Band 802.11n Wireless LAN Front-End
Preliminary Information

LNA Enable Logic		LNA Function		Comment
V_LNA	Bsel	2.4 GHz LNA	5 GHz LNA	
VRENH	VRENH	Bypass Mode	Bypass Mode	No gain in either path. This can be used for high input signal conditions.
VRENH	VRENH	Bypass Mode	Bypass Mode	No gain in either path. This can be used for high input signal conditions.
VRENH	VRENH	Off	On	Activates a-band LNA
VRENH	VRENH	On	Off	Activates bg-band LNA

RF Switch Characteristics

Conditions: $V_{CC} = V_{EN} = 3.3\text{ V}$, $T_A = 25\text{ }^\circ\text{C}$, as measured on Skyworks Solutions' SE2595L-EV1 evaluation board (de-embedded to device), all unused ports terminated with 50 ohms, unless otherwise noted.

Symbol	Parameter	Conditions	Min.	Typ.	Max.	Unit
VCTL_ON	Control Voltage (On State)	-	3.0	-	3.6	V
VCTL_OFF	Control Voltage (OFF State)	-	0.0	-	0.2	V
SW_ON	Low Loss Switch Control Voltage	High State = VCTL_ON - VCTL_OFF	2.8	-	V _{CC}	V
SW_OFF	High Loss Switch Control Voltage	Low State = VCTL_OFF - VCTL_OFF	0	-	0.2	V
ICTL_ON	Switch Control Bias Current (RF Applied)	On pin (TX, RX) being driven high. RF Applied	-	-	100	μA
ICTL_ON	Switch Control Bias Current (No RF)	On pin (TX, RX) being driven high. No RF	-	-	30	μA
CCTL	Control Input Capacitance	-	-	-	100	pF

RF Switch Logic		RF Switch Function	
CTRL_T	CTRL_R	Tg, Ta – ANT	Rg, Ra – ANT
SW_ON	SW_OFF	ON	OFF
SW_OFF	SW_ON	OFF	ON

DATA SHEET
SE2595L: Dual-Band 802.11n Wireless LAN Front-End
Preliminary Information

2.4 GHz AC Electrical Characteristics

2.4 GHz Transmit Characteristics

Conditions: $V_{CC} = 3.3\text{ V}$, $ENg = TX = 3.3\text{ V}$, $V_{LNA} = ENa = RX = 0\text{ V}$, $T_A = 25\text{ }^\circ\text{C}$, as measured on Skyworks Solutions' SE2595L-EV1 evaluation board (de-embedded to device), all unused ports terminated with 50 ohms, unless otherwise noted.

Symbol	Parameter	Condition	Min.	Typ.	Max.	Unit
F_{IN}	Frequency Range	-	2400	-	2485	MHz
$P_{802.11g}$	Output power	54 Mbps OFDM signal, 64QAM, EVM $\leq 3.0\%$	17	18	-	dBm
$P_{802.11b}$	Output power	11 Mbps CCK signal, BT = 0.45 ACPR(Adj) < -32 ACPR(Alt) < -52	19	20	-	dBm
BEVM	Backed Off EVM	54 Mbps, OFDM signal, 64 QAM, P $\leq 12\text{ dBm}$	-	1.5	-	%
P_{1dB}	P1dB	-	-	23	-	dBm
S_{21}	Small Signal Gain	2400 – 2485 MHz 960 – 1600 MHz 1600 – 1660 MHz 3260 – 3267 MHz	23 - - -	- - - -	30 0 0 2	dB
ΔS_{21}	Small Signal Gain Variation Over Band	Over any 40 MHz band	-	-	0.5	dB
$2f, 3f$	Harmonics	$P_{out} = 18\text{ dBm}$, 1 Mbps, BPSK	-	-50	-45.2	dBm
		$P_{out} = 17\text{ dBm}$, 54Mbps OFDM signal	-	-55	-48.2	
NF	Noise Figure	$P_{out} < 20\text{ dBm}$	-	-	10	dB
t_r	Rise Time	10 % to 90% of final output power level	-	-	0.5	μs
t_{dr}, t_{df}	Delay and rise/fall Time	50 % of V_{EN} edge and 90/10 % of final output power level	-	-	0.5	μs
S_{11}	Input Return Loss	-	-	10	-	dB
Spur	Spurious	$P_{out} < 20\text{ dBm}$, VSWR = 2:1 100 MHz to 10 GHz	-	-	-45	dBm/MHz
STAB	Stability	$P_{OUT} \leq 20\text{ dBm}$ Load VSWR = 10:1	All non-harmonically related outputs less than -50 dBc/1MHz			

DATA SHEET
SE2595L: Dual-Band 802.11n Wireless LAN Front-End
Preliminary Information

2.4 GHz Receive Characteristics

Conditions: VCC = V_LNA = Bsel = RX = 3.3V, ENg = ENa = TX = 0 V, TA = 25 °C, as measured on Skyworks Solutions' SE2595L-EV1 evaluation board (de-embedded to device), all unused ports terminated with 50 ohms, unless otherwise noted.

Symbol	Parameter	Condition	Min.	Typ.	Max.	Unit
F _{OUT}	Frequency Range	-	2400	-	2500	MHz
S ₂₁	Receive Gain, LNA enabled.	2400 – 2485 MHz	11	13	-	dB
		800 – 1200 MHz	-	-	-10	
1200 – 1700 MHz		-	-	3		
1700 – 1900 MHz		-	-	10		
3200 – 6000 MHz		-	10	-		
	Receive Gain, Bypass mode	V_LNA = 0 V 2400 – 2485 MHz	-	-7	-	dB
ΔS ₂₁	Gain Variation	2400 – 2485 MHz, Over any 40MHz band	-	-	.5	dB
NF	Noise Figure		-	2.6 7	2.8 -	dB
IIP3	Third Order Intercept	2.45GHz, 1MHz offset	-	9	-	dBm
ISOL _{RRX}	Reverse Isolation	V_LNA = 0V, RX = 0 V	-	-23	-	dB
INT	Interferer	With this input , IIP3 can only degrade by 1dB	-10	-	-	dBm
S ₁₁	Input Return Loss	-	10	12	-	dB
IP1dB	Input P1dB	V_LNA = 3.3 V V_LNA = 0 V	-	-3.5 8	-	dBm
T _{EN}	Enable Time	10% to 90% of RX RF power, from time that V_LNA is at 50%	-	-	500	nsec

DATA SHEET
SE2595L: Dual-Band 802.11n Wireless LAN Front-End
Preliminary Information

5 GHz AC Electrical Characteristics

5 GHz Transmit Characteristics

Conditions: VCC = 3.3 V, ENa = TX = 3.3 V, V_LNA = ENg = RX = 0 V, TA = 25 °C, as measured on Skyworks Solutions' SE2595L-EV1 evaluation board (de-embedded to device), all unused ports terminated with 50 ohms, unless otherwise noted.

Symbol	Parameter	Condition	Min.	Typ.	Max.	Unit
F _{IN}	Frequency Range	-	4900	-	5850	MHz
P _{802.11a}	Nominal Output Power	54 Mbps OFDM signal, 64 QAM, EVM = 3.0 %	-	16	-	dBm
BEVM	Backed Off EVM	54 Mbps, OFDM signal, 64 QAM, P ≤ 7 dBm	-	1.5	-	%
P _{1dB}	P1DB	-	-	21	-	dBm
S ₂₁	Small Signal Gain	4900 – 5850 MHz	22	-	31	dB
		960 – 3265 MHz	-	-30	10	
		3265 – 3900 MHz	-	-10	8	
		6900 – 7250 MHz	-	-10	6	
		7250 – 7800 MHz	-	-12	-10	
ΔS ₂₁	Small Signal Gain Variation Over 40 MHz Channel		-	0.4	-	dB
	Small Signal Gain Variation Over Band		-	6	-	dB
2f,3f	Harmonics, 54Mbps, 802.11a signal	P _{out} = 16dBm 4900 – 5150 MHz 5150 – 5850 MHz	- -	-45 -50	-42 -48	dBm/MHz
NF	Noise Figure	P _{out} < 16 dBm 4900 – 5850 MHz	-	-	10	dB
t _r	Rise Time	10 % to 90% of final output power level	-	-	0.8	μs
t _{dr} , t _{df}	Delay and rise/fall Time	50 % of V _{EN} edge and 90/10 % of final output power level	-	-	0.5	μs
S ₁₁	Input Return Loss	-	-	8	-	dB
SPUR	Spurious	P _{out} < 16dBm, VSWR = 2:1, 100 – 24000 MHz	-	-	-45	dBm/MHz
STAB	Stability	P _{OUT} ≤ 17 dBm Load VSWR = 10:1	All non-harmonically related outputs less than -50 dBc/1MHz			

DATA SHEET
SE2595L: Dual-Band 802.11n Wireless LAN Front-End
Preliminary Information

5 GHz Receive Characteristics

Conditions: $V_{CC} = V_{LNA} = RX = 3.3$ V, $Bsel = ENg = ENa = TX = 0$ V, $T_A = 25$ °C, as measured on Skyworks Solutions' SE2595L-EV1 evaluation board (de-embedded to device), all unused ports terminated with 50 ohms, unless otherwise noted.

Symbol	Parameter	Condition	Min.	Typ.	Max.	Unit
F _{OUT}	Frequency Range	-	4900	-	5850	MHz
S ₂₁	Receive Gain	4900 – 5850 MHz	-	12	-	dB
		800 – 2500 MHz	-	-10	-5	
2500 – 3900 MHz		-	6	-		
6500 – 7800 MHz		-	11	-		
	Receive Gain, Bypass mode	$V_{LNA} = 0.0$ V	-	-7	-	dB
ΔS_{21}	Gain Variation	4900 – 5850 MHz, Over any 40MHz band	-	-	0.5	dB
NF	Noise Figure		-	2.8	3.2	dB
IIP3	Third Order Intercept	5.45GHz, 1MHz offset	-	-3	-	dBm
ISOL _{RRX}	Reverse Isolation	$V_{LNA} = 0V$, $RX = 0V$	-	20	-	dB
INT	Interferer	With this input IIP3 can only degrade by 1dB	-10	-	-	dBm
S ₁₁	Return Loss	-	-	8	-	dB
IP1dB	Input P1dB	$V_{LNA} = 3.3$ V $V_{LNA} = 0$ V	-	-3 10	-	dBm
T _{EN}	Enable Time	10% to 90% of RX RF power, from time that V_{LNA} is at 50%	-	-	500	nsec

2.4 GHz Power Detector Characteristics

Conditions: $V_{CC} = 3.3$ V, $ENg = TX = 3.3$ V, $V_{LNA} = RX = ENa = 0$ V, $T_A = 25$ °C, as measured on Skyworks Solutions' SE2595L-EV1 evaluation board (de-embedded to device), all unused ports terminated with 50 ohms, unless otherwise noted.

Symbol	Parameter	Condition	Min.	Typ.	Max.	Unit
F _{OUT}	Frequency Range	-	2400	-	2500	MHz
PDR	Power detect range, peak power	Measured at ANT	0	-	22	dBm
PDZ _{LOAD}	DC load impedance	-	-	2.7	3	k Ω
PDV _{P22}	Output Voltage, P _{OUT} = 21 dBm	-	-	0.86	-	V
PDV _{p0}	Output Voltage, P _{OUT} = 5 dBm	-	-	0.35	-	V

DATA SHEET
SE2595L: Dual-Band 802.11n Wireless LAN Front-End
Preliminary Information

Symbol	Parameter	Condition	Min.	Typ.	Max.	Unit
PDV _{pnoRF}	Output Voltage, P _{OUT} = No RF	-	-	0.32	-	V
LPF _{-3dB} (Note 2)	Power detect low pass filter -3dB corner frequency	Load = high impedance Typ: 500 kΩ	270	300	400	KHz

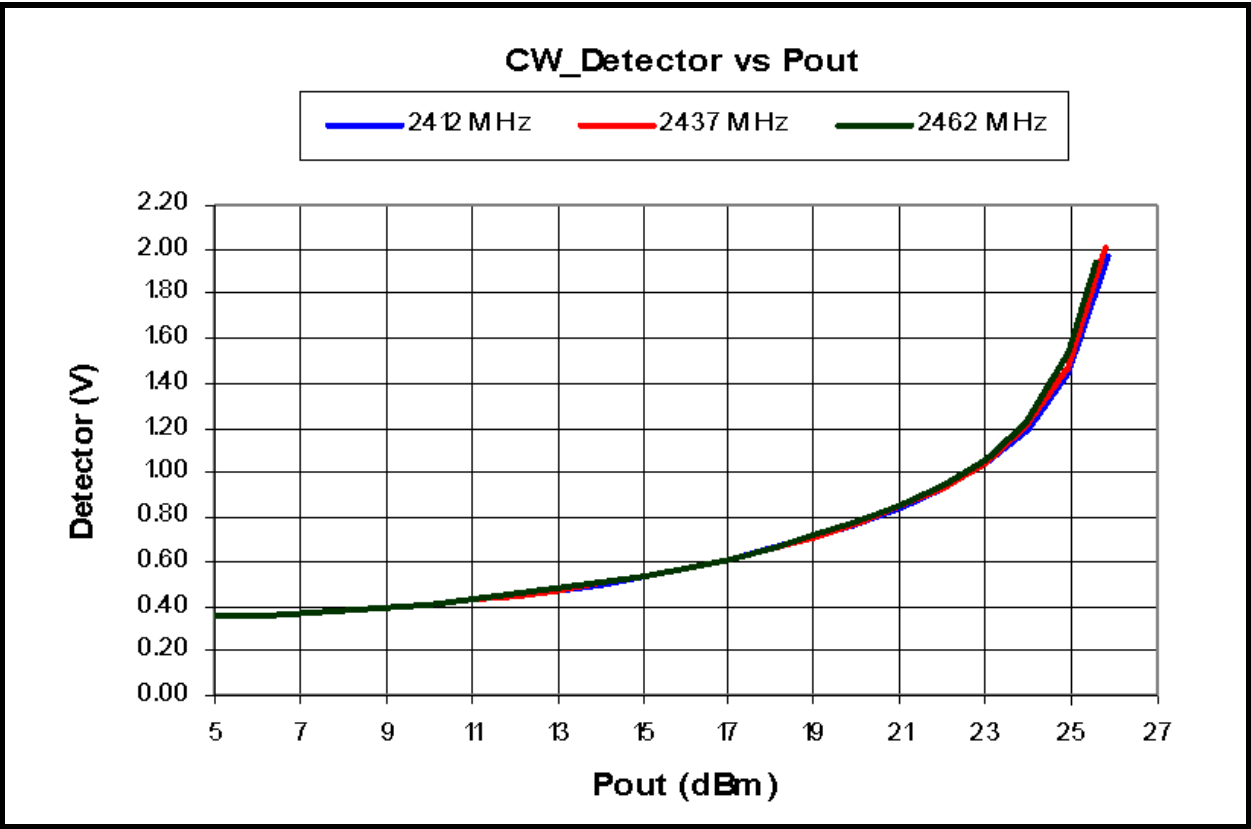

Figure 3: Power Detector Characteristics



DATA SHEET
SE2595L: Dual-Band 802.11n Wireless LAN Front-End
Preliminary Information

5 GHz Power Detector Characteristic

Conditions: $V_{CC} = 3.3\text{ V}$, $E_{NA} = TX = 3.3\text{ V}$, $V_{LNA} = RX = ENg = 0\text{ V}$, $T_A = 25\text{ }^\circ\text{C}$, as measured on Skyworks Solutions' SE2595L-EV1 evaluation board (de-embedded to device), all unused ports terminated with 50 ohms, unless otherwise noted.

Symbol	Parameter	Condition	Min.	Typ.	Max.	Unit
F_{OUT}	Frequency Range	-	4900	-	5850	MHz
PDR	Power detect range, peak power	Measured at ANT	0	-	20	dBm
PDZ _{LOAD}	DC load impedance	-	-	2.7	3	k Ω
PDV _{P20}	Output Voltage, $P_{OUT} = 17\text{ dBm}$	-	-	0.80	-	V
PDV _{p0}	Output Voltage, $P_{OUT} = 3\text{ dBm}$	-	-	0.34	-	V
PDV _{pnoRF}	Output Voltage, $P_{OUT} = \text{No RF}$	-	-	0.32	-	V
LPF _{-3dB} (Note 3)	Power detect low pass filter -3dB corner frequency	Load = high impedance Typ: 500 k Ω	270	300	400	KHz

DATA SHEET
SE2595L: Dual-Band 802.11n Wireless LAN Front-End
Preliminary Information

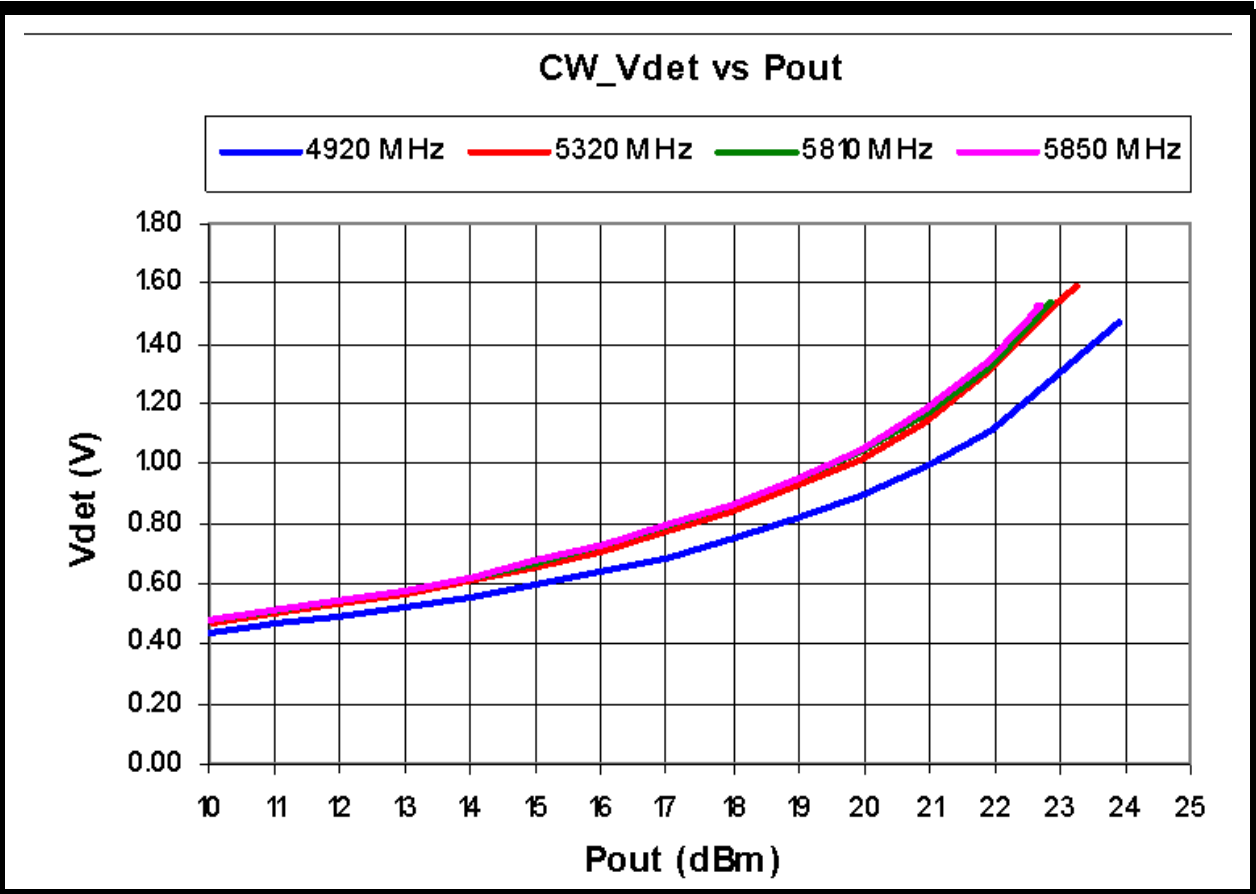

DATA SHEET
SE2595L: Dual-Band 802.11n Wireless LAN Front-End
Preliminary Information

Package Diagram

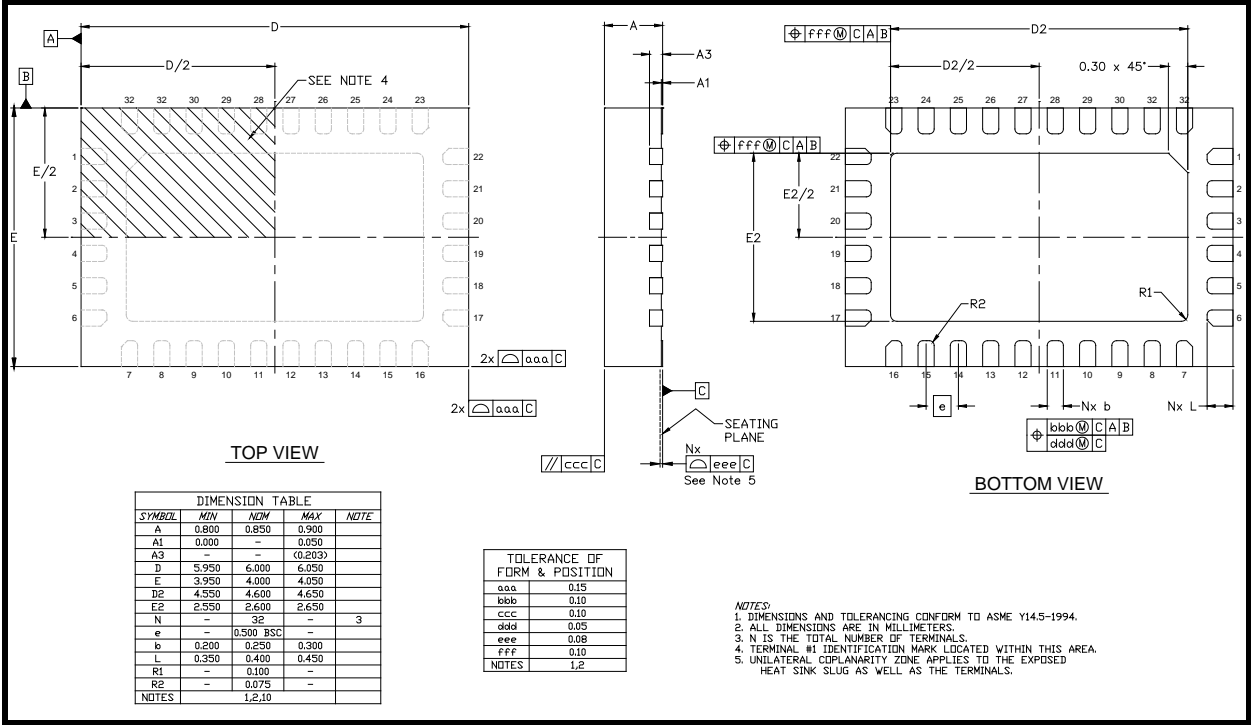

Figure 4: Package Outline Drawing

Recommended Land and Solder Patterns

DATA SHEET
SE2595L: Dual-Band 802.11n Wireless LAN Front-End
Preliminary Information

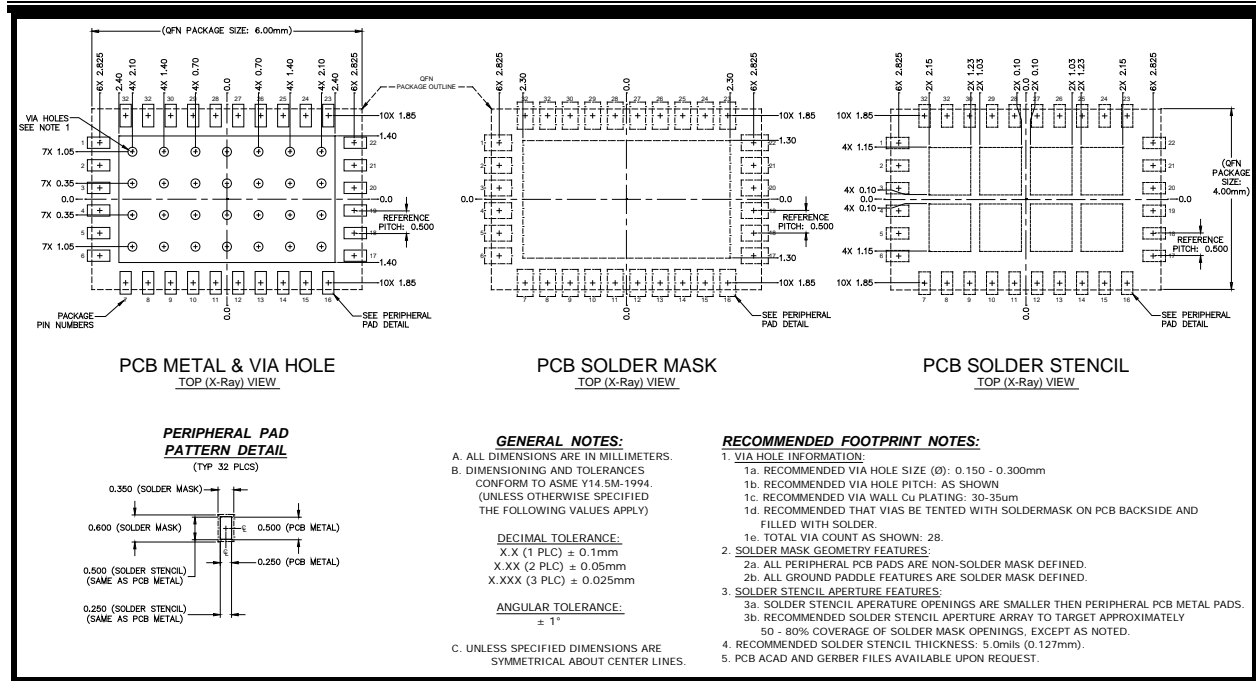

Figure 5: Recommended Land and Solder Pattern

Package Handling Information

Because of its sensitivity to moisture absorption, instructions on the shipping container label must be followed regarding exposure to moisture after the container seal is broken, otherwise, problems related to moisture absorption may occur when the part is subjected to high temperature during solder assembly. The SE2595L is capable of withstanding a Pb free solder reflow. Care must be taken when attaching this product, whether it is done manually or in a production solder reflow environment. If the part is manually attached, precaution should be taken to insure that the device is not subjected to temperatures above its rated peak temperature for an extended period of time. For details on both attachment techniques, precautions, and handling procedures recommended, please refer to:

- “Quad Flat No-Lead Module Solder Reflow & Rework Information”, *Document Number QAD-00045*
- “Handling, Packing, Shipping and Use of Moisture Sensitive QFN”, *Document Number QAD-00044*
- “ESD Control Policy”, *Document Number SQ03-0062*



Caution! Class 0 ESD sensitive device

DATA SHEET
SE2595L: Dual-Band 802.11n Wireless LAN Front-End
Preliminary Information

Tape and Reel Information

Parameter	Value
Devices Per Reel	3000
Reel Diameter	13 inches
Tape Width	16 millimeters

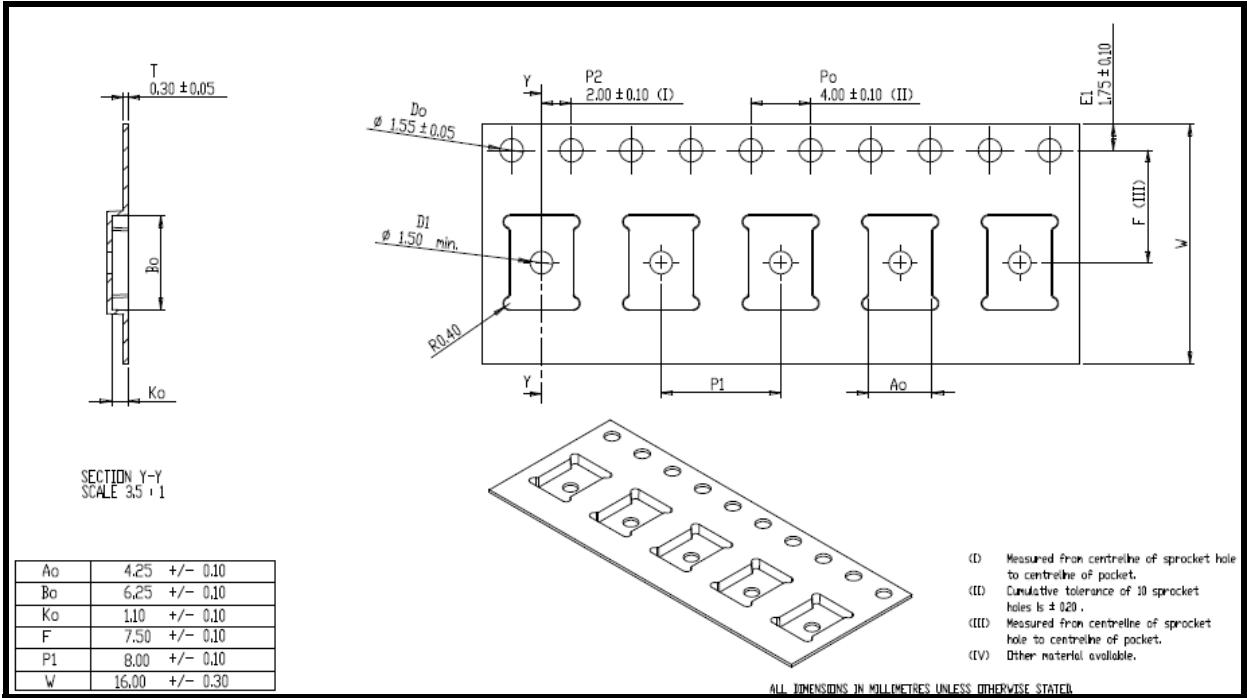

Figure 6: Tape and Reel Information

Branding Information

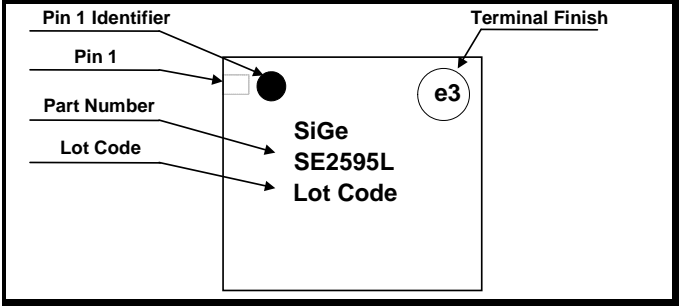

Figure 7: SE2595L Branding Information



DATA SHEET
SE2595L: Dual-Band 802.11n Wireless LAN Front-End
Preliminary Information

Document Change History

Revision	Date	Notes
1.0	June 29, 2008	Create
1.1	March 11, 2009	Update Gain in both bands Updated detector characteristics Updated packing method to Tape & Reel Added package outline drawing and recommended land pattern Updated input return loss. Updated RX IIP3
1.2	April 6, 2009	Updated LNA characteristics. Corrected product and terminal finish marking on Branding information
1.3	April 29, 2009	Updated LNA Logic Characteristics (I_{RENH}) to 400uA
1.4	May 1, 2009	Updated detector characteristics
1.5	July 30, 2009	Updated 5GHz Gain Characteristics
1.6	Aug 28, 2009	Updated Tape and Reel drawings.
1.7	Jan 11, 2010	Updated ICC_OFF specification.
1.8	Jan 8, 2011	Updated MSL rating to MSL 1
1.9	Apr 9, 2011	Updated recommended operating conditions to industrial temperature range
2.0	Mar 28, 2012	Updated with Skyworks logo and disclaimer statement



DATA SHEET
SE2595L: Dual-Band 802.11n Wireless LAN Front-End
Preliminary Information

Copyright © 2012 Skyworks Solutions, Inc. All Rights Reserved.

Information in this document is provided in connection with Skyworks Solutions, Inc. ("Skyworks") products or services. These materials, including the information contained herein, are provided by Skyworks as a service to its customers and may be used for informational purposes only by the customer. Skyworks assumes no responsibility for errors or omissions in these materials or the information contained herein. Skyworks may change its documentation, products, services, specifications or product descriptions at any time, without notice. Skyworks makes no commitment to update the materials or information and shall have no responsibility whatsoever for conflicts, incompatibilities, or other difficulties arising from any future changes.

No license, whether express, implied, by estoppel or otherwise, is granted to any intellectual property rights by this document. Skyworks assumes no liability for any materials, products or information provided hereunder, including the sale, distribution, reproduction or use of Skyworks products, information or materials, except as may be provided in Skyworks Terms and Conditions of Sale.

THE MATERIALS, PRODUCTS AND INFORMATION ARE PROVIDED "AS IS" WITHOUT WARRANTY OF ANY KIND, WHETHER EXPRESS, IMPLIED, STATUTORY, OR OTHERWISE, INCLUDING FITNESS FOR A PARTICULAR PURPOSE OR USE, MERCHANTABILITY, PERFORMANCE, QUALITY OR NON-INFRINGEMENT OF ANY INTELLECTUAL PROPERTY RIGHT; ALL SUCH WARRANTIES ARE HEREBY EXPRESSLY DISCLAIMED. SKYWORKS DOES NOT WARRANT THE ACCURACY OR COMPLETENESS OF THE INFORMATION, TEXT, GRAPHICS OR OTHER ITEMS CONTAINED WITHIN THESE MATERIALS. SKYWORKS SHALL NOT BE LIABLE FOR ANY DAMAGES, INCLUDING BUT NOT LIMITED TO ANY SPECIAL, INDIRECT, INCIDENTAL, STATUTORY, OR CONSEQUENTIAL DAMAGES, INCLUDING WITHOUT LIMITATION, LOST REVENUES OR LOST PROFITS THAT MAY RESULT FROM THE USE OF THE MATERIALS OR INFORMATION, WHETHER OR NOT THE RECIPIENT OF MATERIALS HAS BEEN ADVISED OF THE POSSIBILITY OF SUCH DAMAGE.

Skyworks products are not intended for use in medical, lifesaving or life-sustaining applications, or other equipment in which the failure of the Skyworks products could lead to personal injury, death, physical or environmental damage. Skyworks customers using or selling Skyworks products for use in such applications do so at their own risk and agree to fully indemnify Skyworks for any damages resulting from such improper use or sale.

Customers are responsible for their products and applications using Skyworks products, which may deviate from published specifications as a result of design defects, errors, or operation of products outside of published parameters or design specifications. Customers should include design and operating safeguards to minimize these and other risks. Skyworks assumes no liability for applications assistance, customer product design, or damage to any equipment resulting from the use of Skyworks products outside of stated published specifications or parameters.

Skyworks, the Skyworks symbol, and "Breakthrough Simplicity" are trademarks or registered trademarks of Skyworks Solutions, Inc., in the United States and other countries. Third-party brands and names are for identification purposes only, and are the property of their respective owners. Additional information, including relevant terms and conditions, posted at www.skyworksinc.com, are incorporated by reference.

X-ON Electronics

Largest Supplier of Electrical and Electronic Components

Click to view similar products for [RF Front End](#) category:

Click to view products by [Skyworks](#) manufacturer:

Other Similar products are found below :

[SE2622L-R](#) [BGM1032N7E6327XUSA1](#) [LX5586LL](#) [SKY85703-11](#) [LX5586HLL](#) [LX5586ALL](#) [SKY66111-21](#) [SKY65728-11](#) [SKY68000-31](#)
[SKY85308-11](#) [SKY85302-11](#) [SKY65724-11](#) [ADTR1107ACCZ](#) [LMP91051MTX/NOPB](#) [SE5501L-R](#) [QPF4519SR](#) [SE5503A-R](#)
[ADA8282WBCPZ](#) [ADRF5545ABCPZN](#) [ADRF5545ABCPZN-R7](#) [AD8283WBCPZ](#) [AD8284WCSVZ](#) [ADRF5547BCPZN](#)
[ADRF5547BCPZN-R7](#) [ADRF5549BCPZN](#) [ADRF5549BCPZN-R7](#) [HV7350K6-G](#) [SE5516A-R](#) [MCP2030-I/SL](#) [MAX2009ETI+](#)
[MAX2078CTK+](#) [MAX2335ETI+](#) [MAX2678GTB/V+T](#) [MD2131K7-G](#) [MD2134K7-G](#) [RFFM6903TR13](#) [HV7351K6-G](#) [MCP2035-I/ST](#)
[SE2614BT-R](#) [SE2438T-R](#) [SST12LF02-QXCE](#) [SST12LF09-Q3CE](#) [RFX2401C](#) [RFX2402E](#) [SKY85201-11](#) [RFFM4591FTR7](#) [RFFM8211TR7](#)
[RFFM4293TR7](#) [RFFM4203TR7](#) [RFFM5765QTR7](#)