

DATA SHEET
SE4150L: GPS Receiver IC
Preliminary Datasheet

Applications

- High sensitivity / low power GPS / A-GPS apps.
- Personal Navigation Devices (PNDs) , mobile phones, and GPS peripheral devices

Product Description

The SE4150L is a highly integrated GPS receiver IC offering high performance and low-power operation in a wide range of low-cost applications. It is particularly well-suited to high sensitivity L1-band GPS systems.

Features

- Single-conversion L1-band GPS radio with integrated IF filter
- Integrated LNA with high-gain (20 dB typ.) and low NF (0.9 dB typ.)
- Integrated antenna switching with active antenna current detection
- Low cascaded system noise figure of 1.2 dB typical
- 2-bit SIGN & MAG digital IF output
- 2.7 V - 3.6 V operation
- Standby current <10 μ A
- Fully integrated PLL synthesizer, VCO & loop filter compatible with 16.368 MHz ref. frequency
- 4 x 4 x 0.9 mm 24 pin QFN
- Pb-free, RoHS compliant and Halogen free

The SE4150L is ideal for use in GPS receivers needing dual-antenna inputs. The SE4150L includes two RF inputs with integrated antenna switching and external active-antenna current detection. A high-linearity on-chip LNA is used with one of the inputs, allowing the SE4150L to be used in multi-function wireless systems, without the need for additional external LNA devices. A fully integrated image-reject low-noise mixer is used with a linear AGC, an on-chip IF filter, and a 2-bit analogue-to-digital converter (ADC).

The SE4150L features two gain control modes, to optimize the performance of the LNA and mixer for systems which either require high signal handling, or systems which need minimal supply current.

The SE4150L synthesizer is fully integrated including the VCO and PLL loop-filter. The synthesizer can operate from a 16.368 MHz reference frequency, normally with an external TCXO.

Ordering Information

Part No.	Package	Remark
SE4150L-R	24 pin QFN	Shipped in Tape & Reel

The SE4150L is optimized for operation from a 3.3 V core power supply. It incorporates current-controlled low-spurious output buffers which may operate from a separate external supply. Output buffers supply sufficient current to drive up to 15 pF load directly.

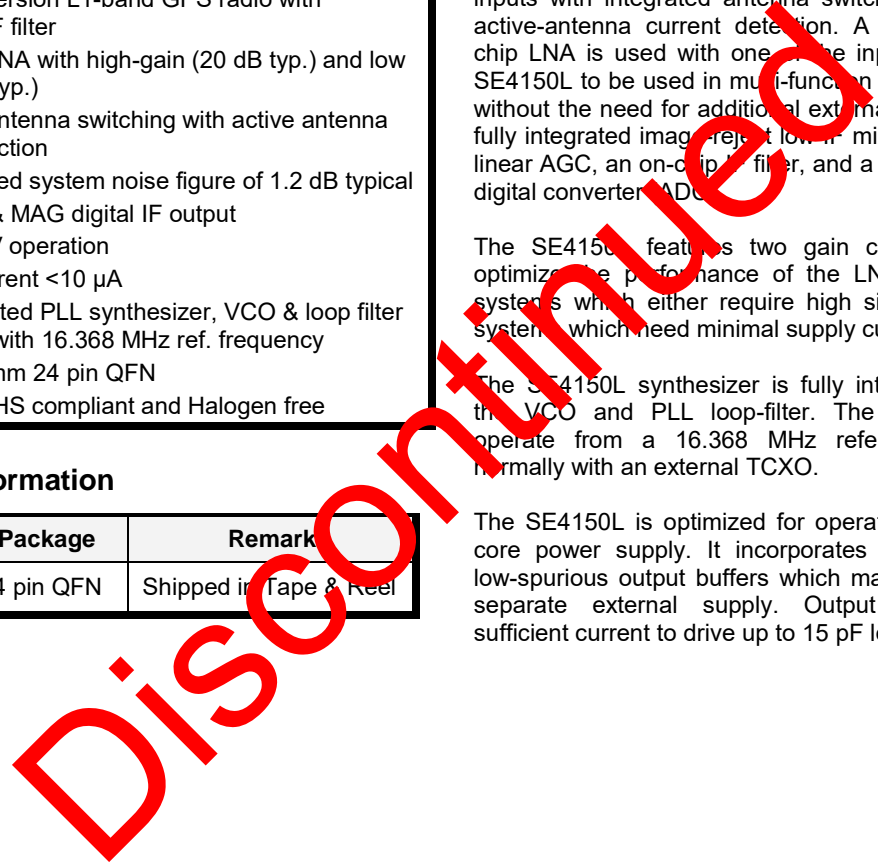

DATA SHEET
SE4150L: GPS Receiver IC
Preliminary Datasheet

Functional Block Diagram

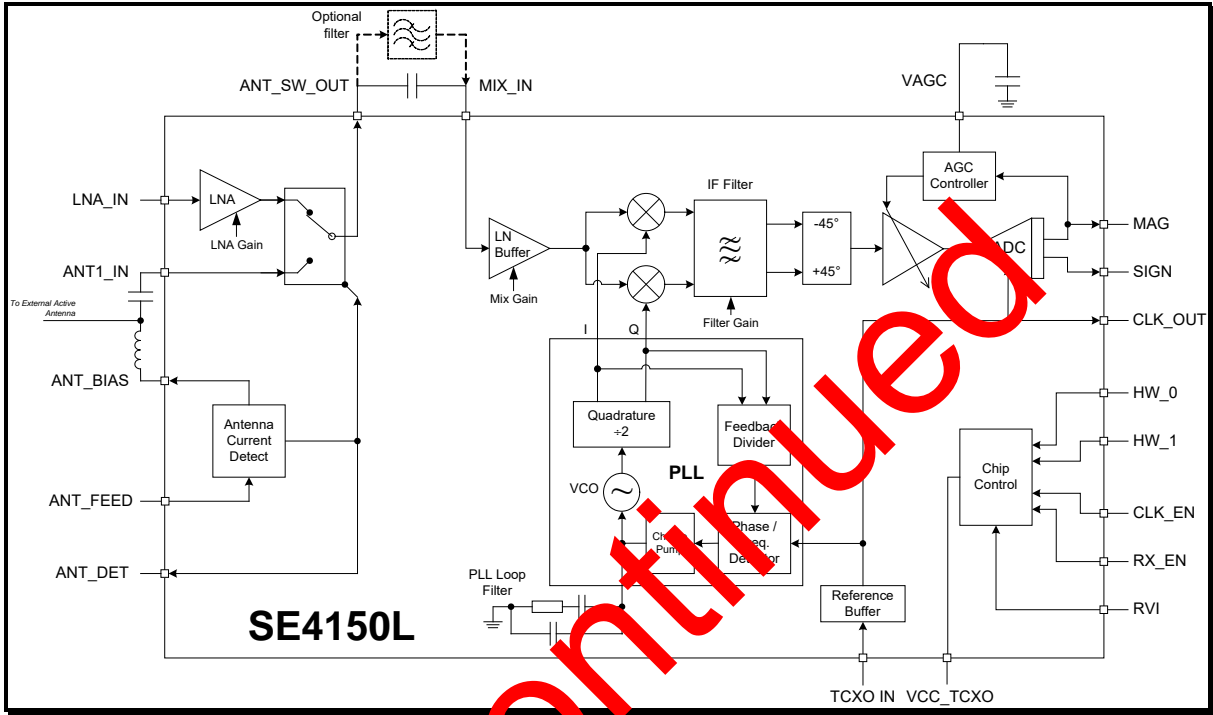

Discontinued

DATA SHEET
SE4150L: GPS Receiver IC
Preliminary Datasheet

Pin Out Diagram

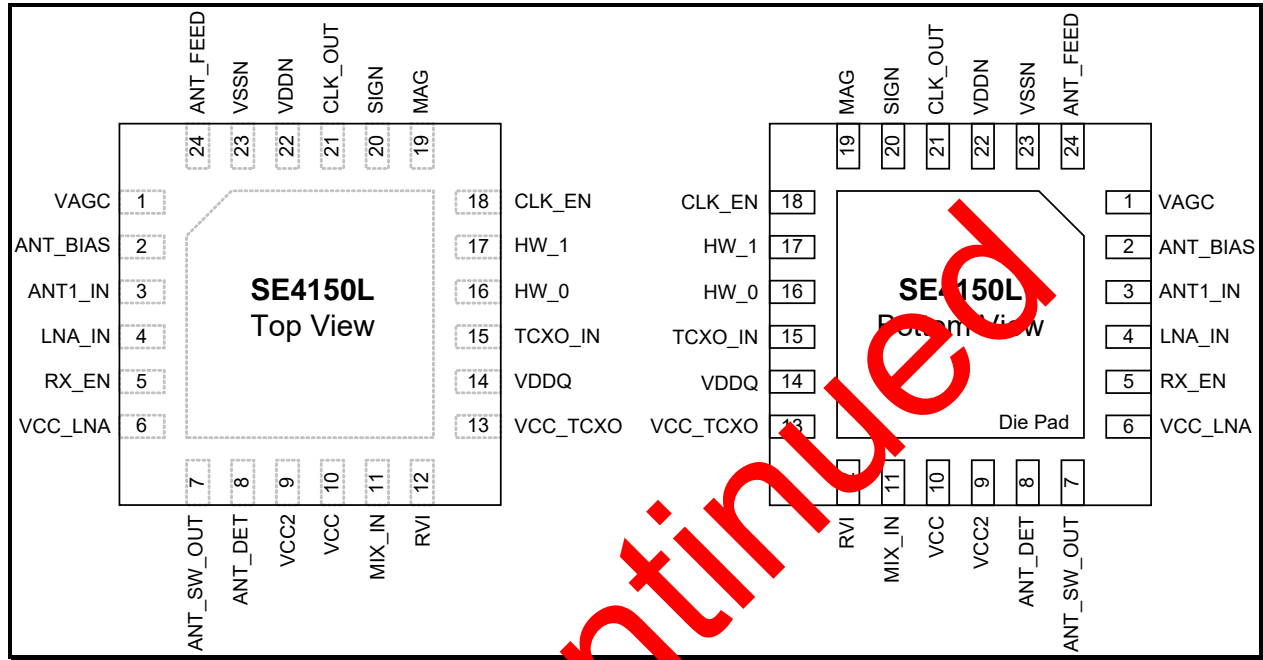

Pin Out Description

Pin No.	Name	Description	Connection
1	VAGC	ACC filter capacitor	Single capacitor (10nF) to GND
2	ANT_BIAS	External antenna bias output	Connect to external antenna on ANT1_IN (pin 3). Use capacitor to DC block the bias from the ANT1_IN input.
3	ANT1_IN	RF input from external antenna	DC bias on this pin. DC blocking capacitor required. Connect to RF input matching network
4	LNA_IN	RF input, via on-chip LNA	DC bias on this pin. Connect either direct to passive GNSS antenna element, or to grounded components using a DC blocking capacitor.
5	RX_EN	Receiver enable	Connect to VDDN to enable radio Connect to VSSN / GND to disable radio
6	VCC_LNA	Analogue power supply for LNA	Connect to VCC via dedicated decoupling network to enable LNA Connect to GND to disable LNA
7	ANT_SW_OUT	Antenna switch output	DC bias on this pin. Connect to SAW filter input or coupling capacitor.

DATA SHEET
SE4150L: GPS Receiver IC
Preliminary Datasheet

Pin No.	Name	Description	Connection
8	ANT_DET	External-antenna connected detect output (<i>controls internal antenna switch</i>)	Logic 1 output (VDDN) = External active antenna connected. Antenna switch routes the ANT1_IN (pin 3) signal to ANT_SW_OUT (pin 7). Logic 0 output (VSSN) = No external active antenna connected. Antenna switch routes the LNA_IN (pin 4) signal to ANT_SW_OUT (pin 7). Antenna switch can be overridden by driving this pin from a DC source (<10kΩ impedance)
9	VCC2	Power supply	Connect to VCC
10	VCC	Power supply	Connect to VCC
11	MIX_IN	Mixer input	DC bias on this pin. Connect to SAW filter output or coupling capacitor.
12	RVI	Program baseband output drive current	Leave unconnected Connect via a resistor to analogue VCC for up to 2x output drive current
13	VCC_TCXO	Power supply to the external TCXO	Connect to the TCXO Supply or leave unconnected
14	VDDQ	Power supply for most digital circuits	Connect to VCC
15	TCXO_IN	TCXO connection	Connect to AC coupled TCXO reference signal
16	HW_0	Hardware mode select pin (bit 0)	Select desired LNA and mixer linearity setting as per "Hardware Configuration" table (Connect to VDDN or VSSN / GND as required)
17	HW_1	Hardware mode select pin (bit 1)	
18	CLK_EN	Clock output enable in standby mode	Connect to VDDN to enable CLK_OUT signal (pin 21) Connect to VSSN / GND to disable CLK_OUT signal
19	MAG	MAG IF output	ADC MAG output to baseband IC, at VDDN logic levels
20	SIGN	SIGN IF output	ADC SIGN output to baseband IC, at VDDN logic levels
21	CLK_OUT	Clock output	ADC sample clock output to baseband IC, at VDDN logic levels
22	VDDN	Digital power supply for digital interface	Connect to VDD, or digital supply for baseband IC
23	VSSN	Ground return for digital interface	Connect to GND, or digital ground for baseband IC
24	ANT_FEED	Power supply to external active antenna, via ANT_BIAS (and antenna current detect IC block)	Connect to VCC

DATA SHEET
SE4150L: GPS Receiver IC
Preliminary Datasheet

Pin No.	Name	Description	Connection
Die Pad	GND	Ground connection	Main IC GND connection

Functional Description

LNA

A high-performance LNA is available for use with systems with an external passive antenna.

The LNA noise figure is the largest single contributor to overall system sensitivity in GPS signal reception. The internal LNA of the SE4150L allows excellent performance to be achieved from a low-power GPS receiver without requiring any additional active components.

The GPS L1 input signal which is applied to LNA_IN (pin 4), is a spread-spectrum signal centered on 1575.42 MHz with a 1.023Mbps BPSK modulation. The signal level at the antenna is typically -130 dBm in open-sky conditions, dropping to below -150 dBm in masked signal areas (e.g. indoors).

The LNA input requires a minimum of external matching components to achieve good RF gain with minimal noise figure. Although attention should be paid to track lengths and interference throughout the design, the LNA input matching circuit is the only RF circuit critically sensitive to layout.

The LNA output includes internal 50Ω matching for connection to the mixer input, either directly or via an optional external filter.

Antenna Switch

An antenna switch is included on the SE4150L, to allow selection of either the LNA_IN (pin 4) RF path, or the ANT1_IN (pin 3) RF path to connect to a single RF output; ANT_SW_OUT (pin 7). This is useful in systems where two antenna sources can be provided (e.g. a PND, where an internal antenna and a socket for an external antenna are available).

The antenna switch is driven from the antenna current detector block. The antenna switch will transfer the RF input from the default LNA_IN (pin 4) over to ANT1_IN (pin 3), when the antenna current detector block senses a current being consumed, for example, from an external active antenna. The switching threshold is typically 1mA with some hysteresis.

Antenna Current Detector

The antenna current detector is designed to monitor the supply current to an external active antenna and provide a logic output, ANT_DET (pin 8). This is used to indicate if the current is within an expected range. The current monitor senses the current which passes through the ANT_BIAS (pin 2) output.

ANT_DET (pin 8) is connected to the switchover control of the internal antenna switch. The antenna switch will transfer the route of the RF input path from the internal LNA (supplied from the LNA_IN (pin 4) input) across to ANT1_IN (pin 3), through to the ANT_SW_OUT (pin 7) output, when current is detected.

ANT_BIAS (pin 2) should be connected to the core connection of a coax socket via an isolating choke for an external active antenna, in conjunction with ANT_IN (pin 3) connected to the same core connection of the socket via a dc-blocking capacitor. When an external active antenna is connected, DC current to drive the active antenna will flow through ANT_BIAS (pin 2), and the antenna current detector.

Antenna Switch Override

The antenna switch (and antenna current detector) can be overridden by externally driving ANT_DET (pin 8) from a low-impedance external source, at VDDN (pin 22) or GND levels.

This can be useful, for example, in applications where the external antenna is not powered by the SE4150L feed, or to facilitate user override via the host processor man-machine interface.

The external source applied to ANT_DET (pin 8) must be able to source >300 uA into the pin, or sink >70 uA out of the pin to allow guaranteed levels to be set.

Mixer RF Input

The mixer RF input, MIX_IN (pin 11), is a single-ended 50 Ω input designed to interface either to ANT_SW_OUT (pin 7) or to the output of an external filter. An external active antenna can also be

DATA SHEET
SE4150L: GPS Receiver IC
Preliminary Datasheet

connected directly to MIX_IN (pin 11) in some applications.

The image reject mixer ensures that the receiver's full sensitivity is achieved without an external filter. For applications where additional selectivity is required, an external filter can be added between the ANT_SW_OUT (pin 7) and MIX_IN (pin 11) pins.

IF Filter

The SE4150L includes a fully integrated Intermediate Frequency (IF) filter which provides excellent interference rejection with no additional external components. The filter has a 3rd order Butterworth bandpass response.

The bandpass response has a nominal bandwidth of 2.2 MHz; the nominal center frequency is preset to 4.092 MHz. These parameters ensure very low implementation loss in all frequency plan configurations.

AGC and ADC

The SE4150L features a linear IF chain with 2-bit SIGN / MAG ADC. SIGN output is pin 20, and MAG output is pin 19.

An Automatic Gain Control (AGC) system is included. This provides 50 dB of gain control range so that the output signal level is held at an optimum level at the input of the ADC.

The MAG data controls the AGC loop, such that the MAG bit is active (HIGH) for approximately 33% of the time.

The SIGN (pin 20) and MAG (pin 19) signals are latched by the falling edge of the sample clock, CLK_OUT (pin 21) within the ADC. The SIGN and MAG signals, once they arrive at the GPS baseband IC, are best re-sampled on the *rising* edge of CLK_OUT, for optimum sample and hold.

The AGC time constant is determined by a single external capacitor, connected between VAGC (pin 1), and VSSN / GND. The settling-time of the AGC is within 10ms with a 10nF capacitor.

PLL and Loop Filter

The entire Phase-Locked Loop (PLL) generating the local oscillator for the mixer is contained on-chip.

A classic three-element RC PLL loop filter has been implemented on-chip between the output of the internal charge pump and GND / VSSN. The PLL

follows a classic 3rd-order response. Typical PLL Loop- Bandwidth is set to be approx. 200kHz.

The reference frequency for the PLL is provided by an external reference source; normally a TCXO.

TCXO Connection

The SE4150L can be used with an external TCXO. The TCXO should have a clipped sinewave signal output which is connected to the TCXO_IN (pin 15) input.

The supply to the external TCXO can be connected to pin 13 of the SE4150L. The VCC_TCXO supply is disabled when the SE4150L is in stand-by mode.

The VCC_TCXO pin can be left floating if a direct connection from VCC to the power supply of the external TCXO is desired.

VCC_TCXO supply modes

CLK_EN Logic level	CLK_EN Logic level	Note	VCC_TCXO output
'0'	'0'	-	OPEN
'0'	'1'	1	VCC
'1'	'1'	1	VCC

Note: (1) TCXO supply current limited to 30 mA max.

Clock and Data Output Coupling

The high input sensitivity achieved by the SE4150L's internal LNA requires careful control of harmonically related sources of interference.

For this reason the CLK_OUT (pin 21), SIGN (pin 20) and MAG (pin 19) outputs provide carefully controlled current and slew-rate. The data and clock outputs of the SE4150L are specified to drive up to 15pF load (N.B. the max standard CMOS input capacitance is 10pF). The output drive of the SE4150L can be adjusted with a resistor connected between VDDQ (pin 14) and RVI (pin 12), as shown in the Logic Output Current Drive Adjustment Settings section below.

The output current drive is determined by a bias current ratio internal to the SE4150L and the external resistor.

DATA SHEET
SE4150L: GPS Receiver IC
Preliminary Datasheet

Hardware Configuration

The SE4150L can be configured to change the LNA Gain/Linearity and the Mixer Gain/Linearity by means of the settings on the HW_0 (pin 16) and HW_1 (pin 17) logic inputs. The adjustment of the gain and linearity allow the SE4150L to be used in differing environments, either with significant co-located interference sources (e.g. mobile phone) or no interference sources (e.g. PND).

LNA Gain & Linearity Selection

The SE4150L supports two settings for gain and input IP3 in the on-chip LNA.

Supported LNA Gain & Linearity Modes

LNA Mode	LNA Gain	LNA IIP3
Hi Gain	20 dB	-6 dBm
Lo Gain	17 dB	-12 dBm

Mixer Gain Selection

The SE4150L supports two gain settings for the on-chip mixer.

Supported Mixer Gain Modes

Mixer Mode	Mixer Buffer Gain
Hi Gain	32 dB
Lo Gain	24 dB

The following truth table gives the settings for hardware configuration of both the LNA Gain/Linearity and also the Mixer Gain/Linearity.

Hardware Configuration

LNA Mode	Mixer Mode	Selection value (HW_<1:0>)
Hi Gain	Hi Gain	11
Lo Gain	Lo Gain	00

Power Management

The SE4150L uses RX_EN (pin 5) to put the device into standby. In standby mode, all circuits are off and the device consumes only leakage current.

The RX_EN input has a 200 kΩ pull-down resistor to GND, on-chip. This ensures that the RFIC will put itself in standby when the RX_EN controller on the baseband is tri-stated to an impedance much greater than 200 kΩ.

The internal LNA can be disabled by connecting the Vcc supply connection to the LNA, VCC_LNA (pin 6) to GND. This may be desirable in some applications, and prevents the LNA from consuming any current, saving approximately 5mA.

The sample clock output, CLK_OUT (pin 21) can be kept active by setting CLK_EN (pin 18) pin to logic '1' (HI). This will cause all circuits required to produce the CLK_OUT signal to remain active, even when the receiver is forced into Standby mode (RX_EN (pin 5) set to Logic '0').

Logic Interfacing

The SE4150L Logic Inputs can either be driven from an external baseband IC, or permanently set by connecting to either VDDN (pin 22) for Logic '1', or GND for Logic '0'. The digital interface on the SE4150L, supplied from VDDN, has been designed to operate at the same voltage as the GPS baseband IC.

The ANT_DET (pin 8) output is sourced from the antenna current detector, and is also connected to the internal antenna switch; the switch toggles the RF signal source automatically when an external active antenna is connected.

The antenna current detector can be overridden by applying a low impedance source (<10kΩ impedance) at VDDN (pin 22) or GND levels to ANT_DET (pin 8), such as a logic output from a GPIO pin on the GPS Baseband IC. This means that automatic switching can be activated by leaving the GPIO pin on the Baseband IC in a high impedance state, or overridden by setting to the appropriate state.

The SE4150L Logic Input and Output signals are shown in the following tables:

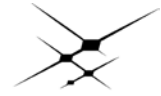

DATA SHEET
SE4150L: GPS Receiver IC
Preliminary Datasheet

SE4150L Logic Inputs

Pin	Name	Description	Logic
5	RX_EN	Receiver enable	'1' Enable receiver '0' Standby mode
8	ANT_DET	Antenna detect antenna-switch override input	'1' Antenna switch routes signal path to ANT_SW_OUT (pin 7) output from ANT1_IN (pin 3) input '0' Antenna switch routes signal path to ANT_SW_OUT (pin 7) output from LNA_IN (pin 4) input, via internal LNA
16	HW_0	Hardware mode select (bit 0)	See table: "Hardware Configuration"
17	HW_1	Hardware mode select (bit 1)	
18	CLK_EN	Enables CLK_OUT (pin 21) while receiver in 'Standby mode' (as configured by RX_EN (pin 5)). When receiver is enabled (RX_EN (pin 5) = '1'), CLK_EN has no effect.	'1' Enable CLK_OUT '0' Disable CLK_OUT

SE4150L Logic Outputs

Pin	Name	Description	Logic
8	ANT_DET	Antenna detect output	'1' Active antenna connected to ANT_BIAS (pin 2) / ANT1_IN (pin 3) '0' No active antenna connected.

Discontinued

DATA SHEET
SE4150L: GPS Receiver IC
Preliminary Datasheet

Absolute Maximum Ratings

These are stress ratings only. Exposure to stresses beyond these maximum ratings may cause permanent damage to, or affect the reliability of the device. Avoid operating the device outside the recommended operating conditions defined below. This IC can be damaged by electro-static discharges. Handling and assembly of this device should be at ESD protected workstations.

Symbol	Parameter	Note	Min.	Max.	Unit
V _{CC} /V _{DD}	Supply Voltage	1	-0.3	+3.6	V
V _X	Voltage On Any Pin With Respect To GND	1, 3	-0.3	V _{DD} + 3	V
LNA_IN _{MAX}	LNA Input Power		-	+3	dBm
ANT1_IN _{MAX}	ANT1_IN Input Power		-	+3	dBm
ESD	Electrostatic Discharge Immunity (HBM)	1, 2	-	2	kV
T _{STG}	Storage Temperature Range	1	-40	+150	°C
T _{SLDR}	Solder Reflow Temperature	1	-	+260	°C

- Note:**
- (1) No damage assuming only one parameter is set at limit at a time with all other parameters set at or below the recommended operating conditions.
 - (2) ESD checked to the Human Body Model (HBM). A charged 100 pF capacitor discharged through a switch and 1.5 kΩ series resistor into the pin.
 - (3) Maximum voltage on any pin should not exceed 3.6 V.

Recommended Operating Conditions

Symbol	Parameter	Note	Min.	Max.	Unit
T _A	Ambient Operating Temperature	-	-40	+85	°C
V _{CC}	Main Supply Voltage		2.7	3.6	V
V _{DDN}	Digital I/O Supply Voltage	1	2.7	3.6	V

- Note:** (1) V_{DDN} cannot exceed V_{CC}

DC Electrical Characteristics

Conditions: V_{CC} = V_{DDN} = 3.3 V, T_A = 25°C

Symbol	Parameter	Min.	Typ.	Max.	Unit
I _{CC}	Total Supply Current, All Circuits Active	-	15	18	mA
I _{CC(LNA_OFF)}	Total Supply Current, All Circuits Active except LNA	-	10	13	mA
I _{CC(CLK)}	Total supply current, receiver Shut Down, clock circuits only active	-	1	-	mA
I _{CC(OFF)}	Supply Current, All Circuits Shut Down	-	-	10	μA
I _{CC(LNA)}	LNA Supply Current	-	5	-	mA

DATA SHEET
SE4150L: GPS Receiver IC
Preliminary Datasheet

AC Electrical Characteristics, LNA

Conditions: $V_{CC} = V_{DDN} = 3.3\text{ V}$, $T_A = 25^\circ\text{C}$, $f_{RF} = 1575.42\text{ MHz}$ unless otherwise stated

Symbol	Parameter	Note	Min.	Typ.	Max.	Unit
I _{CC_LNA}	LNA Supply Current	1	-	5.0	-	mA
		2	-	3.0	-	mA
S _{21_LNA}	Forward Gain	1	-	20	-	dB
		2	-	17	-	dB
NF _{LNA}	Noise Figure	1, 3	-	0.9	-	dB
		2, 3	-	1.1	-	dB
IP1dB	Input compression point		-	-13	-	dBm
IIP3 _{LNA}	Input IP3, tones at 1575 ± 50 MHz @ -40 dBm	1	-	-6	-	dBm
		2	-	-12	-	dBm
S _{11_LNA}	S ₁₁ , into 50 Ω, f _{RF} = 1570 MHz to 1580 MHz	3	-	-8	-	dB
S _{22_LNA}	S ₂₂ , into 50 Ω, f _{RF} = 1570 MHz to 1580 MHz		-	-15	-	dB

Note: (1) LNA mode set to "High gain". HW_1 = '1'
 (2) LNA mode set to "Low gain". HW_1 = '0'
 (3) With specified input matching network

AC Electrical Characteristics, External Antenna Path

Conditions: $V_{CC} = V_{DDN} = 3.3\text{ V}$, $T_A = 25^\circ\text{C}$

Symbol	Parameter	Min.	Typ.	Max.	Unit
IL _{ANTSW1}	Insertion Loss, ANT1_IN to ANT_SW_OUT	-	0.7	-	dB
ISOL _{ANTSW}	Isolation Between Switch Input Ports	-	-20	-	dB
S _{11ANTSW}	S ₁₁ , into 50 Ω, ANT1_IN enabled	-	-15	-	dB
S _{22ANTSW}	S ₂₂ , into 50 Ω, ANT_SW_OUT enabled	-	-15	-	dB

DATA SHEET
SE4150L: GPS Receiver IC
Preliminary Datasheet

DC Electrical Characteristics, Antenna Current Detector

Conditions: $V_{CC} = V_{DDN} = 3.3\text{ V}$, $T_A = 25^\circ\text{C}$,

Symbol	Parameter	Note	Min.	Typ.	Max.	Unit
I_{ON_ABIAS}	Current Threshold for ANT_DET = HI	1	-	1	-	mA
I_{OFF_ABIAS}	Current Threshold for ANT_DET = LO	1	-	0.85	-	mA
$V_{DROPOUT_10m}$	ANT_FEED to ANT_BIAS Drop-out Voltage, 10 mA load	-	-	0.075	-	V
$V_{DROPOUT_5m}$	ANT_FEED to ANT_BIAS Drop-out Voltage, 5 mA load	-	-	0.04	-	V
I_{LIM_ABIAS}	Short-circuit Current Limit, ANT_BIAS	2	-	-	-	mA

Note: (1) Detection thresholds have hysteresis; OFF threshold < ON threshold by ~ 150 μA .
 (2) Short circuit current can be sustained indefinitely.

Discontinued



DATA SHEET
SE4150L: GPS Receiver IC
Preliminary Datasheet

AC Electrical Characteristics, Receiver

Conditions: $V_{CC} = V_{DDN} = 3.3\text{ V}$, $T_A = 25^\circ\text{C}$, $f_{RF} = 1575.42\text{ MHz}$ unless otherwise stated

Symbol	Parameter	Note	Min.	Typ.	Max.	Unit
G _{MIXER}	Voltage Gain of Mixer and Low Noise Buffer	1	-	32	-	dB
		2		24		dB
NF _{RX}	Noise Figure, $f_{RF} = 1570\text{ MHz To } 1580\text{ MHz}$, Input to MIX_IN (pin 11)	1	-	6.5	-	dB
S _{11RX}	S ₁₁ , into 50 Ω, $f_{RF} = 1570\text{ MHz to } 1580\text{ MHz}$	-	-	-14		dB
f _{IF}	IF Center Frequency (16.368 MHz reference)	3	-	4.092	-	MHz
	IF Center Frequency (16.367667 MHz reference)	3	-	+4.124	-	MHz
	IF Center Frequency (16.3676 MHz reference)	3	-	+4.1304	-	MHz
MIX_IR	Mixer Image Rejection	4	20	30		dB
BW	Filter -3 dB Bandwidth	5	-	2.2	-	MHz
A _{RIP}	Filter Amplitude ripple, $f_C \pm 512\text{ kHz}$	-	-	0.5	-	dBpp
AV ₂	Selectivity at $f_C \pm 2\text{ MHz}$	-	-	8	-	dB
AV ₄	Selectivity at $f_C \pm 4\text{ MHz}$	-	-	23	-	dB
G _{BPF}	Gain of Band-pass Filter	-	-	25	-	dB
G _{AGCMAX}	Gain of AGC, Maximum	-	-	42	-	dB
G _{AGCMIN}	Gain of AGC, Minimum	-	-	-8	-	dB
P _{MAX}	Maximum Signal Level at MIX_IN (pin 11) (for normal AGC operation)	6	-	-	-137	dBm/Hz

- Note:**
- (1) Mixer mode set to "High gain". HW_0 = '1'
 - (2) Mixer mode set to "Low gain". HW_0 = '0'
 - (3) Positive IF frequency denotes no spectral inversion, negative frequency has inverted spectrum
 - (4) Ratio of level through mixer between wanted input signal at 1575.42 MHz and image signal at 1567.236 MHz (ref. freq. = 16.368 MHz).
 - (5) Centered at IF CF = 4.092 MHz.
 - (6) The application should be designed to meet this maximum level across 1575.42 ±5 MHz. An absence of strong interferers is assumed.

DATA SHEET
SE4150L: GPS Receiver IC
Preliminary Datasheet

AC Electrical Characteristics, VCO and Local Oscillator

Conditions: $V_{CC} = V_{DDN} = 3.3\text{ V}$, $T_A = 25^\circ\text{C}$

Symbol	Parameter	Note	Min.	Typ.	Max.	Unit
f_{LO}	LO Center Frequency (16.368 MHz reference)	1	-	1571.328	-	MHz
	LO Center Frequency (16.367667 MHz reference)	1	-	1571.296	-	MHz
	LO Center Frequency (16.3676 MHz reference)	1	-	1571.2896	-	MHz
L_{1k}	LO SSB Phase Noise at 1 kHz Offset	2	-	-82	-	dBc/Hz
L_{10k}	LO SSB Phase Noise at 10 kHz Offset	2	-	-82	-	dBc/Hz
L_{100k}	LO SSB Phase Noise at 100 kHz Offset	2	-	-85	-	dBc/Hz
f_{CLK}	CLK_OUT (pin 21) Frequency (16.368 MHz reference)	-	-	16.368	-	MHz

- Note:** (1) VCO frequency operates at 2x LO frequency.
 (2) Typical PLL Loop Bandwidth = 200 kHz

AC Electrical Characteristics, Reference Oscillator Input

Conditions: $V_{CC} = V_{DD} = 3.3\text{ V}$, $T_A = 25^\circ\text{C}$

Symbol	Parameter	Note	Min.	Typ.	Max.	Unit
V_{IN}	External oscillator drive level	-	0.2	1	1.7	V p-p

Discontinued

DATA SHEET
SE4150L: GPS Receiver IC
Preliminary Datasheet

Logic Level Characteristics – Input Pins

Conditions: $V_{CC} = V_{DDN} = 3.3\text{ V}$, $T_A = 25^\circ\text{C}$. Applies to logic pins used as inputs: RX_EN (pin 5), HW_0 (pin 16), HW_1 (pin 17) and CLK_EN (pin 18).

Symbol	Parameter	Note	Min.	Typ.	Max.	Unit
V_{IH}	Logic High Input Voltage	-	$0.7 V_{DDN}$	-	V_{DDN}	V
V_{IL}	Logic Low Input Voltage	-	0	-	0.4	V
I_{IH}	Input Current Logic High Voltage	-	-	200	-	nA
$I_{IH_RX_EN}$	Input Current Logic High Voltage for RX_EN Input (pin 5)	1	-	16.5	-	μA
I_{IL}	Input Current Logic Low Voltage	-	-	-20	-	nA
C_{ILOAD}	Input Load Capacitance	-	-	-	2	pF

Note: (1) Applies to RX_EN (pin 5) only. Figure dominated by 200k Ω (nominal) on-chip pull-down resistor.

Logic Level Characteristics – Output Pins

Conditions: $V_{CC} = V_{DDN} = 3.3\text{ V}$, $T_A = 25^\circ\text{C}$. Applies to logic pins used as outputs: CLK_OUT (pin 21), SIGN (pin 20), and MAG (pin 19).

Symbol	Parameter	Note	Min.	Typ.	Max.	Unit
V_{OH}	Logic High Output Voltage	-	$V_{DDN} - 0.1\text{V}$	-	V_{DDN}	V
V_{OL}	Logic Low Output Voltage	-	0	-	0.1	V
C_{OLOAD}	Output Load Capacitance	-	-	-	15	pF

Note: (1) Output Current set at nominal level; no Current Setting Resistor on RVI (pin 12). Positive value indicates current source, negative value indicates current sink.

ANT_DET (pin 8) Characteristics:

ANT_DET (pin 8) is an input and output logic signal. In output mode, it operates as an indicator of the current through ANT_BIAS (pin 2). In input mode, an input needs to be applied which overrides the output from the pin, to force the internal antenna-switch.

ANT_BIAS Current	Note	External Forced I/P on ANT_DET	Isink	Impedance to V_{CC}	ANT_DET Output Logic Level	Antenna Switch Signal Path (to ANT_SW_OUT)
<0.85mA	1	-	300 μA	∞	LO (0)	LNA_IN
>1mA	2	-	0 μA	50k Ω	HI (1)	ANT1_IN
<0.85mA	1,3	Low impedance to VCC	150 μA	∞	Forced HI	ANT1_IN
>1mA	2	Low impedance to GND	0 μA	100k Ω	Forced LO	LNA_IN

Note: (1) No external active antenna connected.
 (2) External active antenna connected
 (3) The difference between the internal logic level and the output level is sensed and the output drive is reduced, to save current

DATA SHEET
SE4150L: GPS Receiver IC
Preliminary Datasheet

Logic Level Characteristics – ANT_DET (pin 8) only

Conditions: $V_{CC} = V_{DDN} = 3.3\text{ V}$, $T_A = 25^\circ\text{C}$

Symbol	Parameter	Note	Min.	Typ.	Max.	Unit
V_{IH_ADET}	Logic High (HI) Input Voltage	1	$0.7 V_{DDN}$	-	V_{DDN}	V
V_{IL_ADET}	Logic Low (LO) Input Voltage	1	0	-	0.4	V
I_{IH_ADET}	Input Current – Logic HI input voltage	1	-	-150	-	μA
I_{IL_ADET}	Input Current – Logic LO input voltage	1	-	$(V_{DDN}-V_{IL_ADET})/0.1$	-	μA
C_{ILOAD_ADET}	Input Load Capacitance	1	-	-	TBD	pF
V_{OH_ADET}	Logic High (HI) Output Voltage	2	$V_{DDN} - 0.1\text{V}$	-	V_{DDN}	V
V_{OL_ADET}	Logic Low (LO) Output Voltage	2	0	-	0.1	V
I_{OH_ADET}	Output Current - Logic HI Output Voltage	2, 3	-	$(V_{DDN}-V_{OH_ADET})/0.05$	-	μA
I_{OL_ADET}	Output Current - Logic LO Output Voltage	2, 3	-	-300	-	μA
C_{OLOAD}	Output Load Capacitance	2	-	-	15	pF

- Note:**
- (1) When ANT_DET (pin 8) forced with an external logic input.
 - (2) When ANT_DET (pin 8) used as a logic output.
 - (3) The ANT_DET (pin 8) output drive is asymmetric. When outputting logic '0', the output looks like a current sink of 300uA. When outputting logic '1', the output looks like a pull up resistor of 50kohm to VCC. The 300uA sink is enough to pull the output logic level to GND, with a 10kΩ resistor to VCC.

Logic Output Current Drive Adjustment Settings

The Logic Outputs on the SE4150L can be adjusted to compensate for parasitics in application board layout. This can be achieved by adding a resistor between RVI (pin 12) and VDDQ (pin 14) as shown below.

The additional inductance capacitance of PCB tracking and connectors between the SE4150L output and baseband IC input is included in these figures.

These figures are Typical only, and are not guaranteed across temperature and silicon process.

Conditions: $V_{CC} = V_{DDN} = 3.3\text{ V}$, $T_A = 25^\circ\text{C}$

Current Setting Resistor Value (RVI (pin 12) to VDDQ (pin 14)) (Ω)	Maximum Allowable Capacitive Loading (pF)	Current Drive Level
<i>Not Fitted</i>	7.5	Nominal
100K	9	X 1.2
39K	10.5	X 1.4
0R	15	X 2.0

DATA SHEET
SE4150L: GPS Receiver IC
Preliminary Datasheet

Logic Timing Characteristics

Conditions: $C_L \leq 15\text{pF}$, $V_{CC} = V_{DDN} = 3.3\text{ V}$, $T_A = 25^\circ\text{C}$ at Maximum Buffer Current

Symbol	Parameter	Note	Min.	Typ.	Max.	Unit
t_{PER}	Clock Period	-	-	61.09	-	ns
t_{PWL}	Clock Low Width	1	10	-	-	ns
t_{PWH}	Clock High Width	1	10	-	-	ns
t_{DEL}	Clock To Data Delay Time	2	-	-	12	ns
t_{SETUP}	Setup Time (CLK_OUT = 16.368 MHz)	1	7	-	-	ns
t_{HOLD}	Hold Time	-	10	-	-	ns
t_R	Rise Time, 10-90%	1	-	-	17	ns
$t_{R/F}$	Rise and Fall Time, 10 - 90%	1	-	-	17	ns

Note: (1) Values dependent on output drive set.
 (2) Maximum values dependent on load capacitance and output drive current level; determined by current-setting resistor connected between V_{CC} and RVI (pin 12).

Logic Output Data Timing Diagram

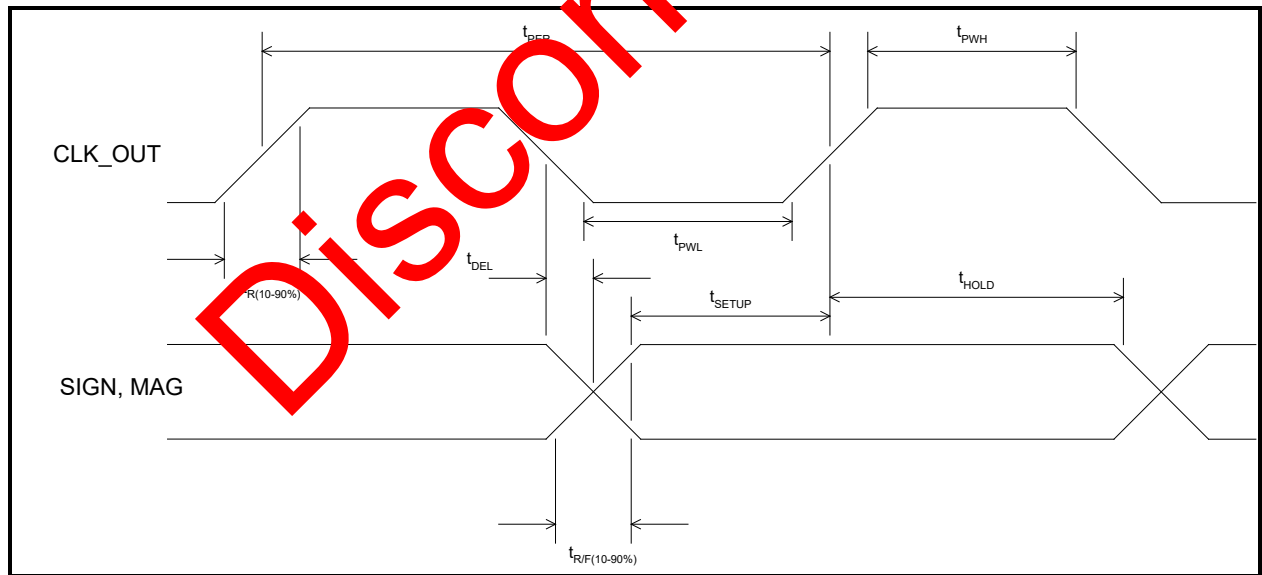

Conditions: (1) Capacitive load on SIGN, MAG and CLK_OUT $\leq 15\text{pF}$
 (2) Output drive set to Maximum: RVI (pin 12) directly connected to V_{CC}

DATA SHEET
SE4150L: GPS Receiver IC
Preliminary Datasheet

Typical Application Circuit Diagram – Standard PND Application

This is a standard PND application circuit with provision for a switched external active antenna. An inter-stage SAW filter is included for improved performance, and is used for both internal and external antenna connections.

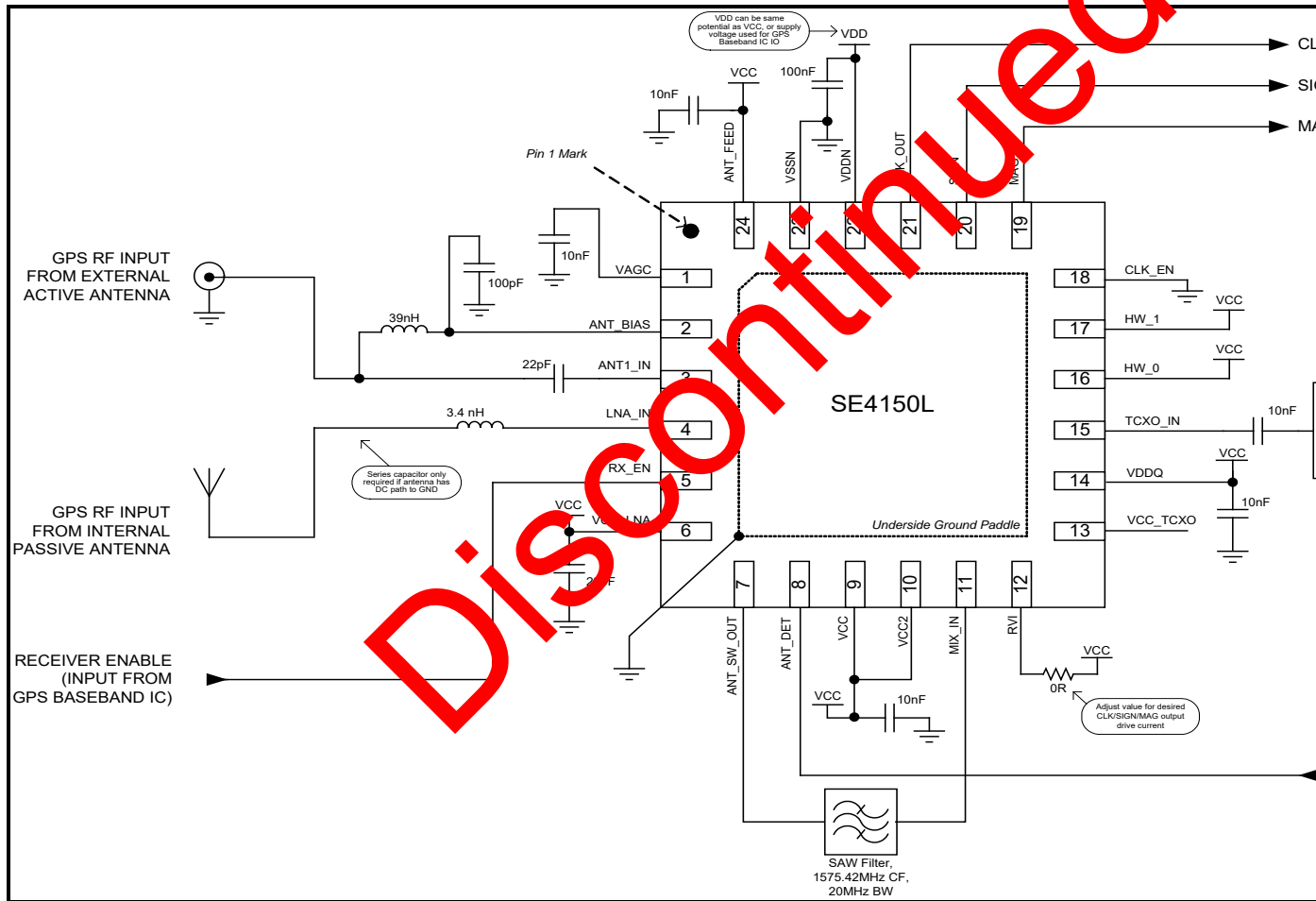

DATA SHEET
SE4150L: GPS Receiver IC
Preliminary Datasheet

Typical Application Circuit Diagram – PND Application with Co-Located Interference Sources

This is a two-SAW circuit with provision for a switched external active antenna. Both a front-end SAW (for the internal antenna) and a full duplex SAW are included for acceptable blocking performance in a co-located interferer environment (e.g. WLAN or cellphone).

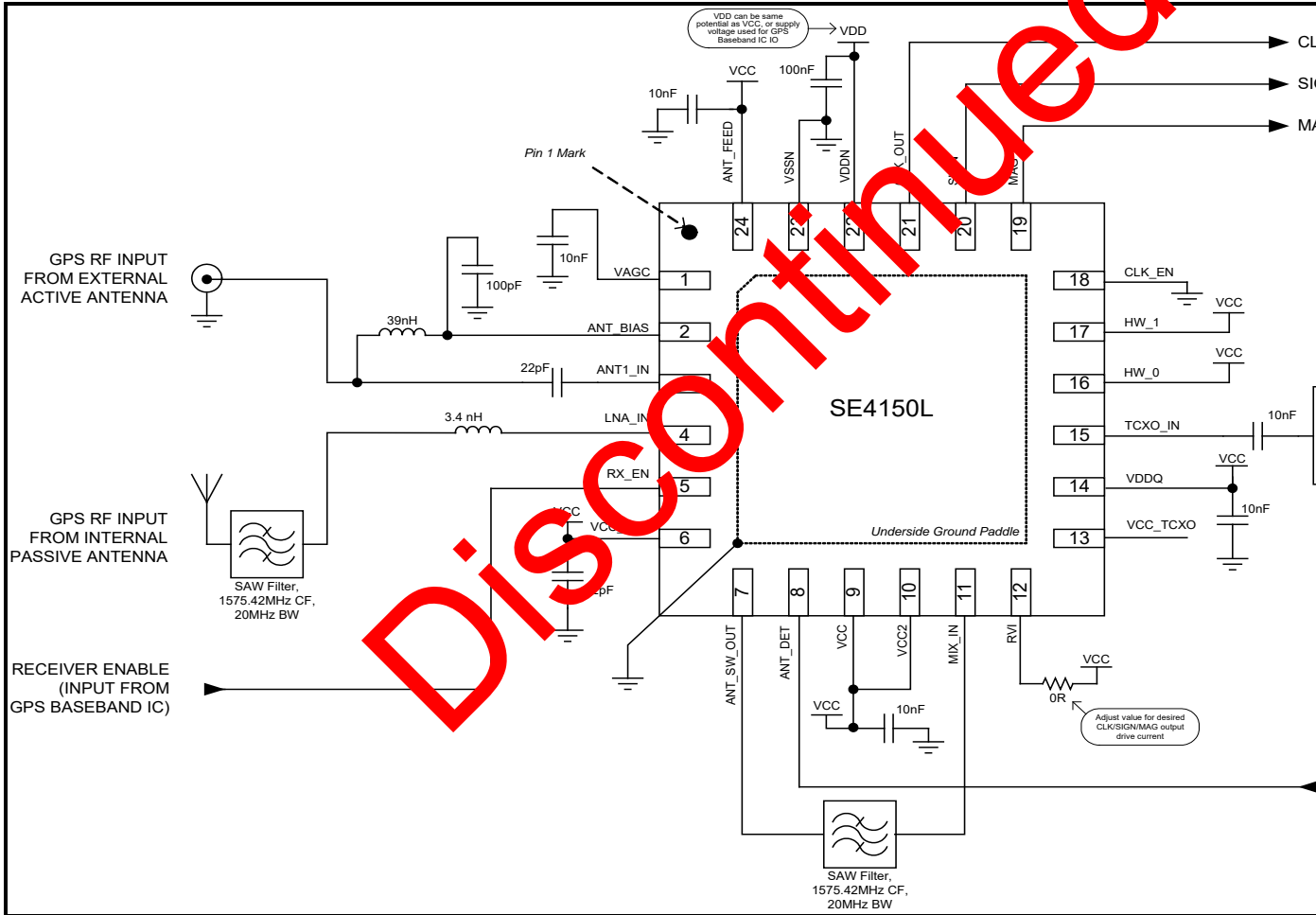

DATA SHEET
SE4150L: GPS Receiver IC
Preliminary Datasheet

Detailed Package Drawing

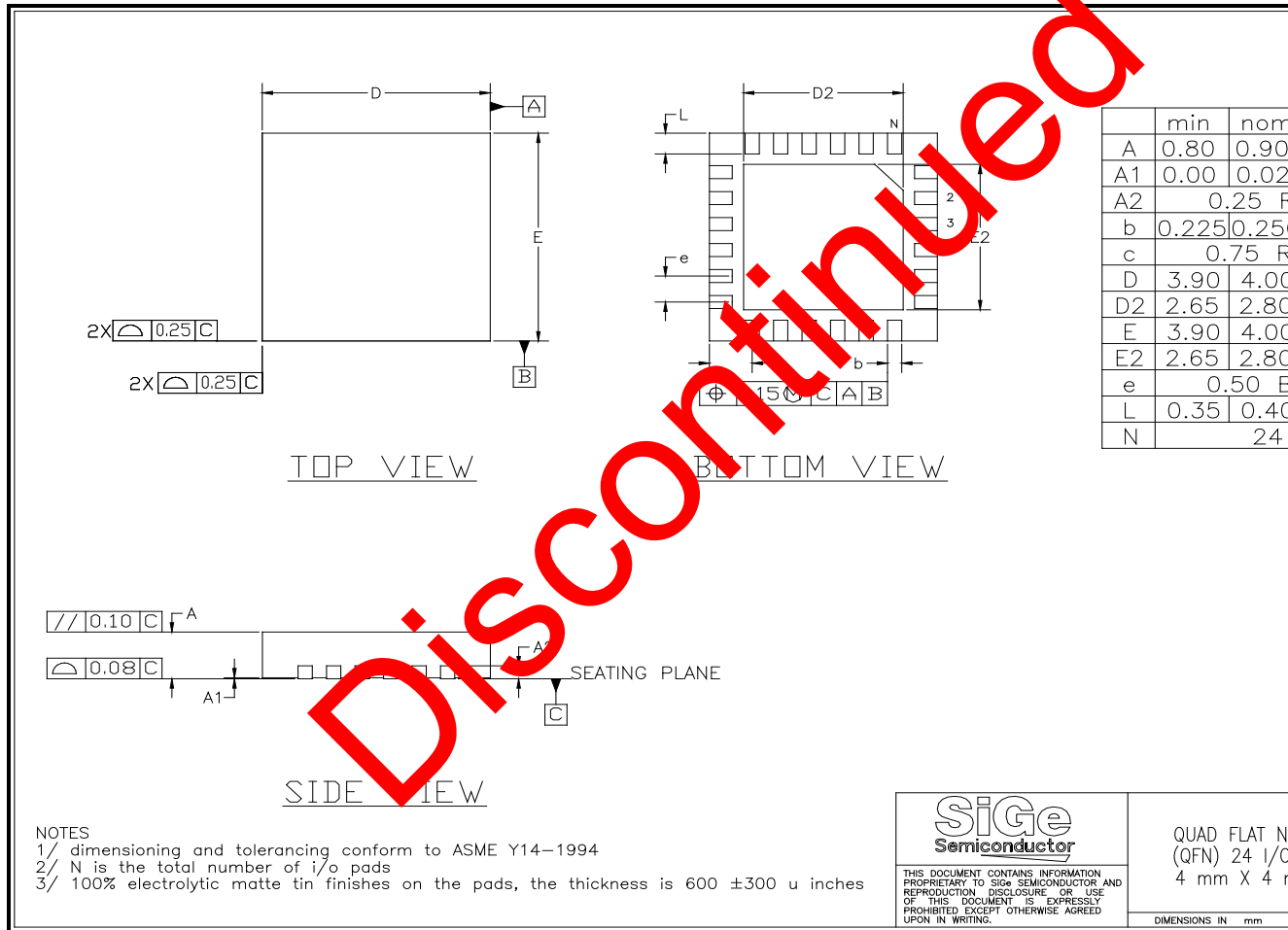

Note: (1) This package is Pb-free, RoHS compliant and Halogen-free. The product is rated MSL1.

DATA SHEET
SE4150L: GPS Receiver IC
Preliminary Datasheet

Recommended PCB Footprint – PCB Metal & Solder Mask

The PCB footprint below is only for reference.

This footprint is a Non-Solder Mask Defined layout [NSMD]. The dotted-green lines define the solder mask apertures. The solid-red lines define the metal pad sizes.

The user should modify the design layout in order to meet their specific solder fillet requirements & solder joint reliability requirements.

All dimensions in the figure below are in mm.

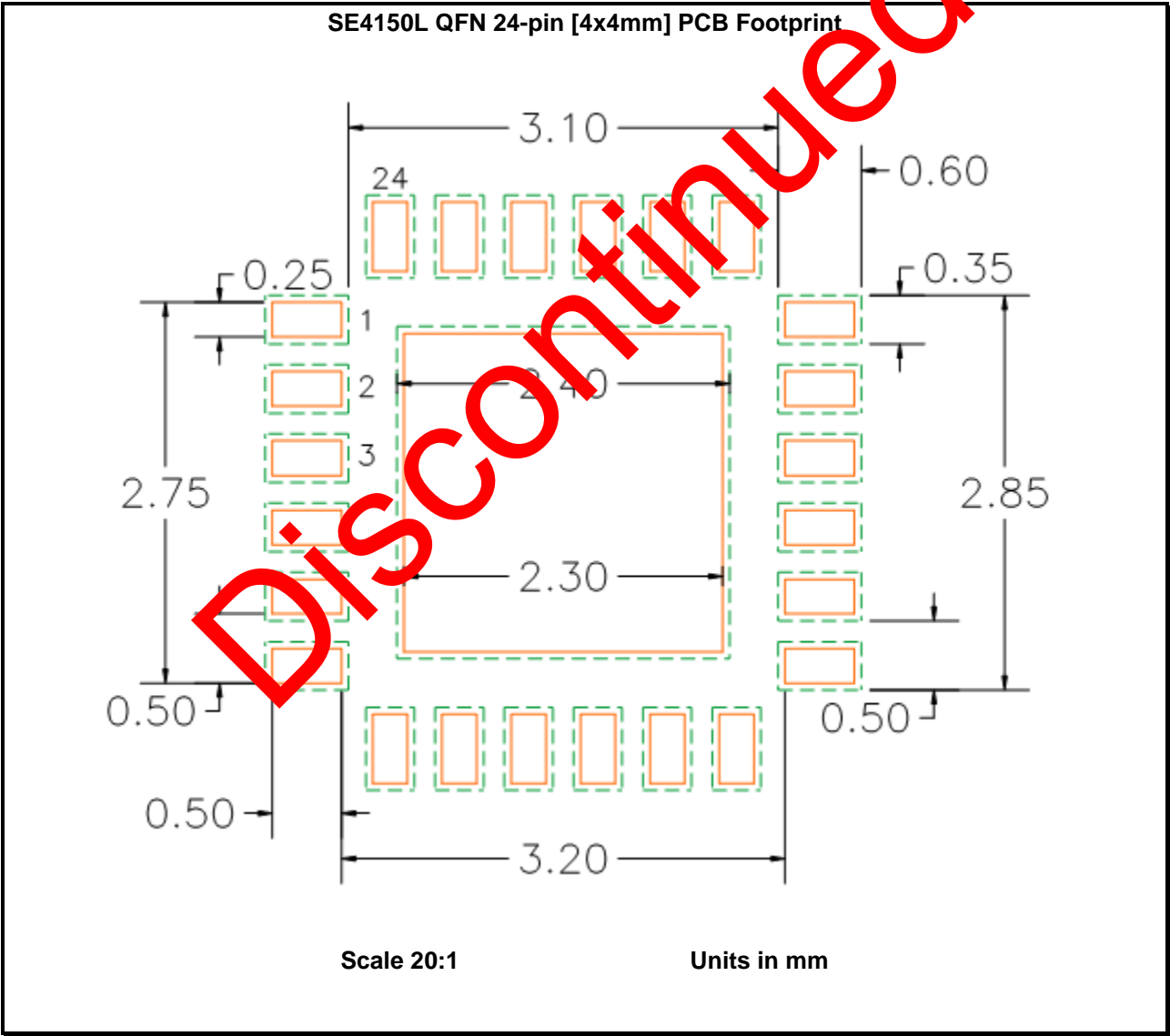

DATA SHEET
SE4150L: GPS Receiver IC
Preliminary Datasheet

Recommended PCB Footprint – Stencil Apertures Pattern

The stencil apertures design below is only for reference.

It is based on a 6mil [0.15mm] stencil thickness with apertures oversized by 1mil [0.025mm] on the pad metal.

The user should modify the design layout in order to meet their particular solder fillet & solder joint reliability requirements.

All dimensions in the figure below are in mm.

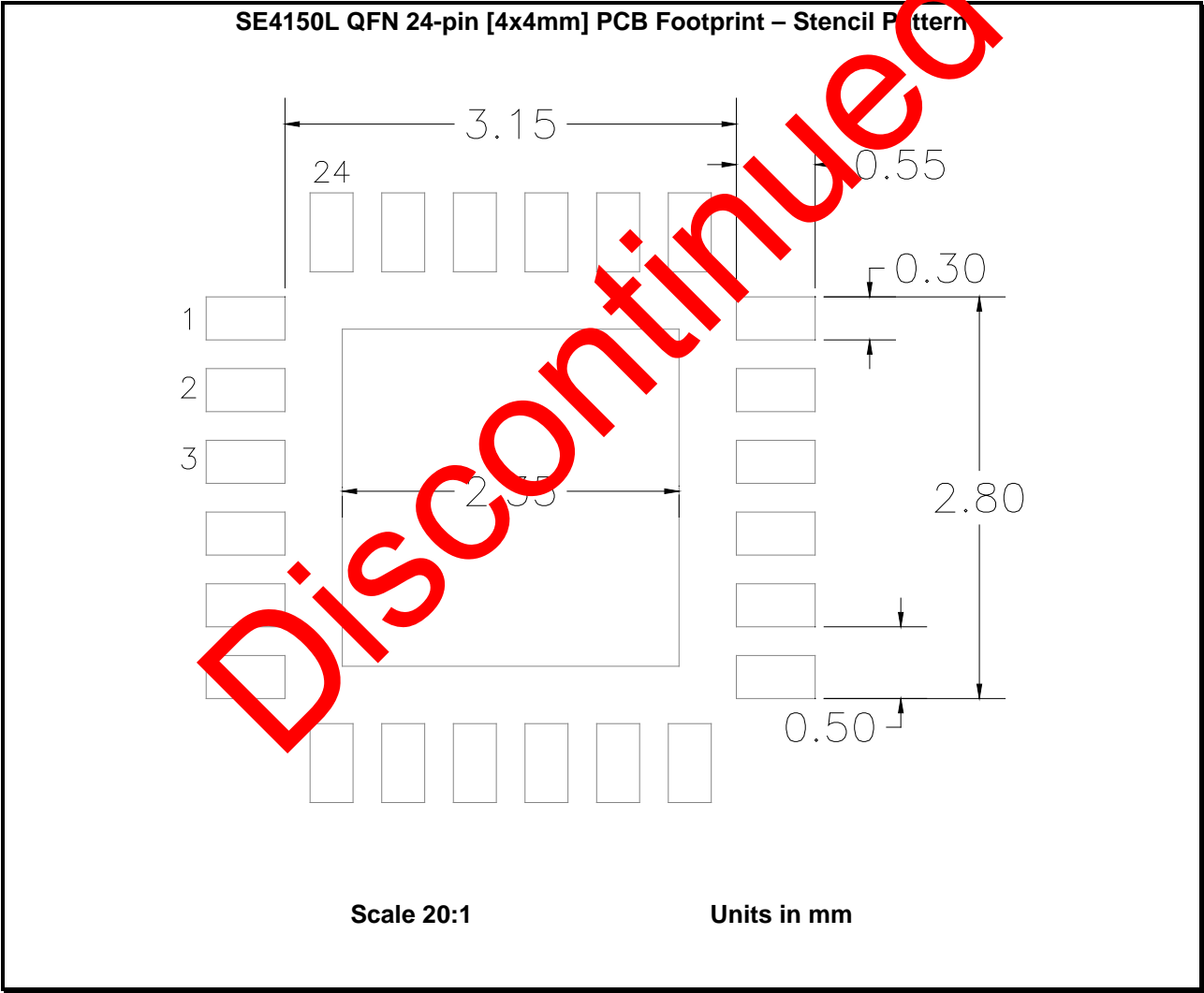

DATA SHEET
SE4150L: GPS Receiver IC
Preliminary Datasheet

Recommended Reflow Temperature Profile

Profile Feature	SnPb Eutectic Assembly	Lead (Pb) Free Assembly
Average Ramp-up Rate (T_L to T_P)	3°C/s (max)	3°C/s (max)
Preheat		
Temperature Min. (T_{smin})	100°C	150°C
Temperature Max. (T_{smax})	150°C	200°C
Time (Min. to Max) (t_s)	60 - 120s	60 - 80s
Ramp Up		
T_{smax} to t_L	-	3°C/s (max)
Time 25°C to Peak Temperature	6 mins. (max)	8 mins. (max)
Reflow		
Temperature (t_L)	183°C	217°C
Time maintained above t_L	60 - 150s	60 - 150s
Peak Temperature (t_p)	240 ± 5°C	260 +0/-5°C
Time Within 5°C of Actual Peak Temperature (t_p)	10 - 30s	20 - 40s
Ramp-Down		
Ramp-Down Rate	6°C/s (max)	6°C/s (max)

Reflow Profile (Reference JEDEC J-STD-020)

Discontinued

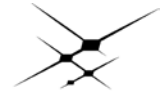

DATA SHEET
SE4150L: GPS Receiver IC
Preliminary Datasheet

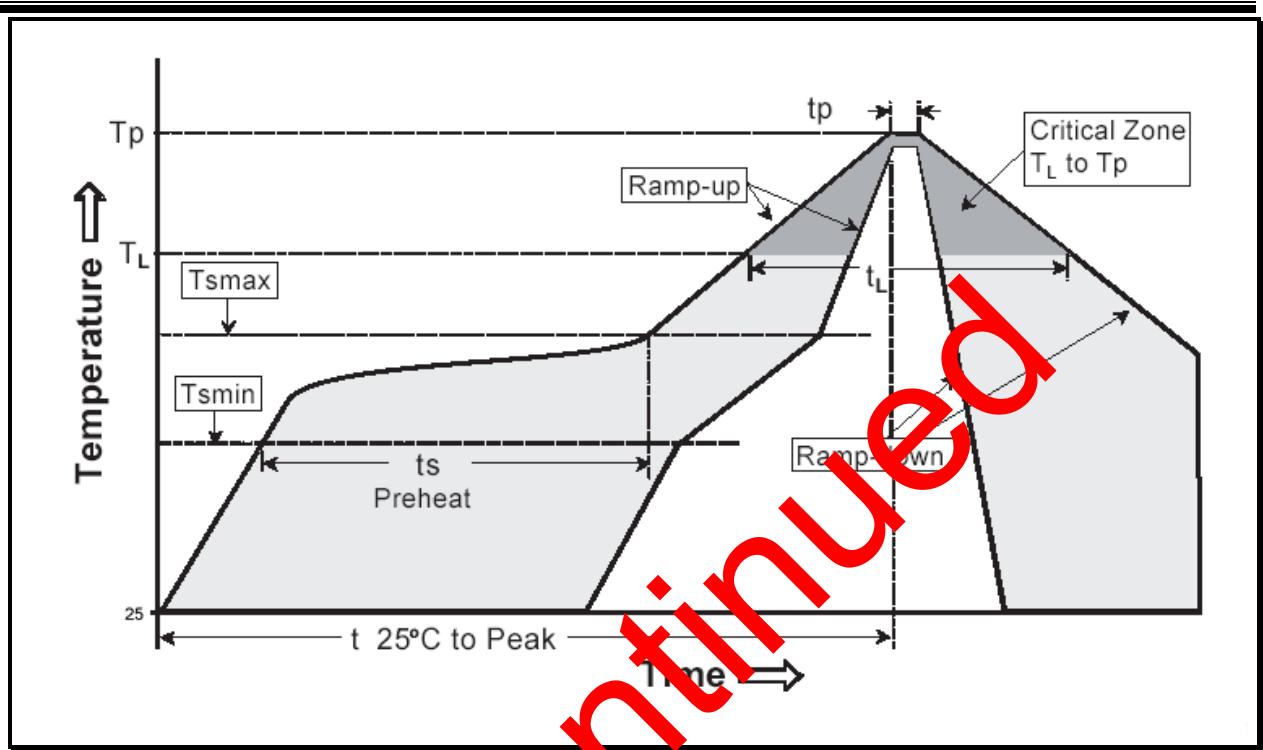

Discontinued

DATA SHEET
SE4150L: GPS Receiver IC
Preliminary Datasheet

Tape and Reel Information

Parameter	Value
Devices Per Reel	3000
Reel Diameter	13 inches
Tape Width	12 millimeters

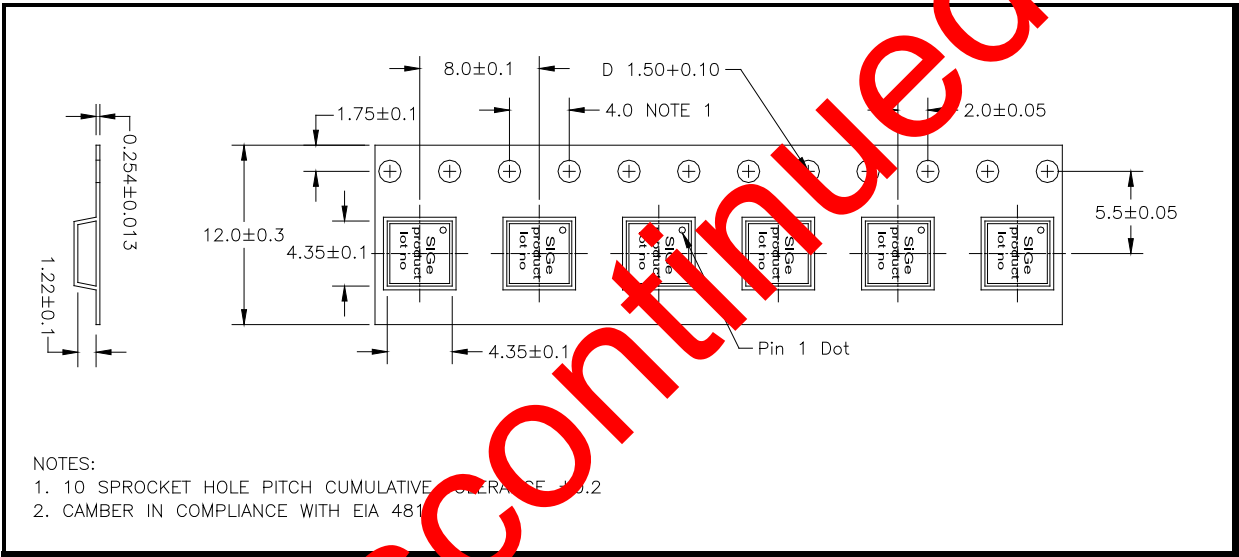

Branding Information

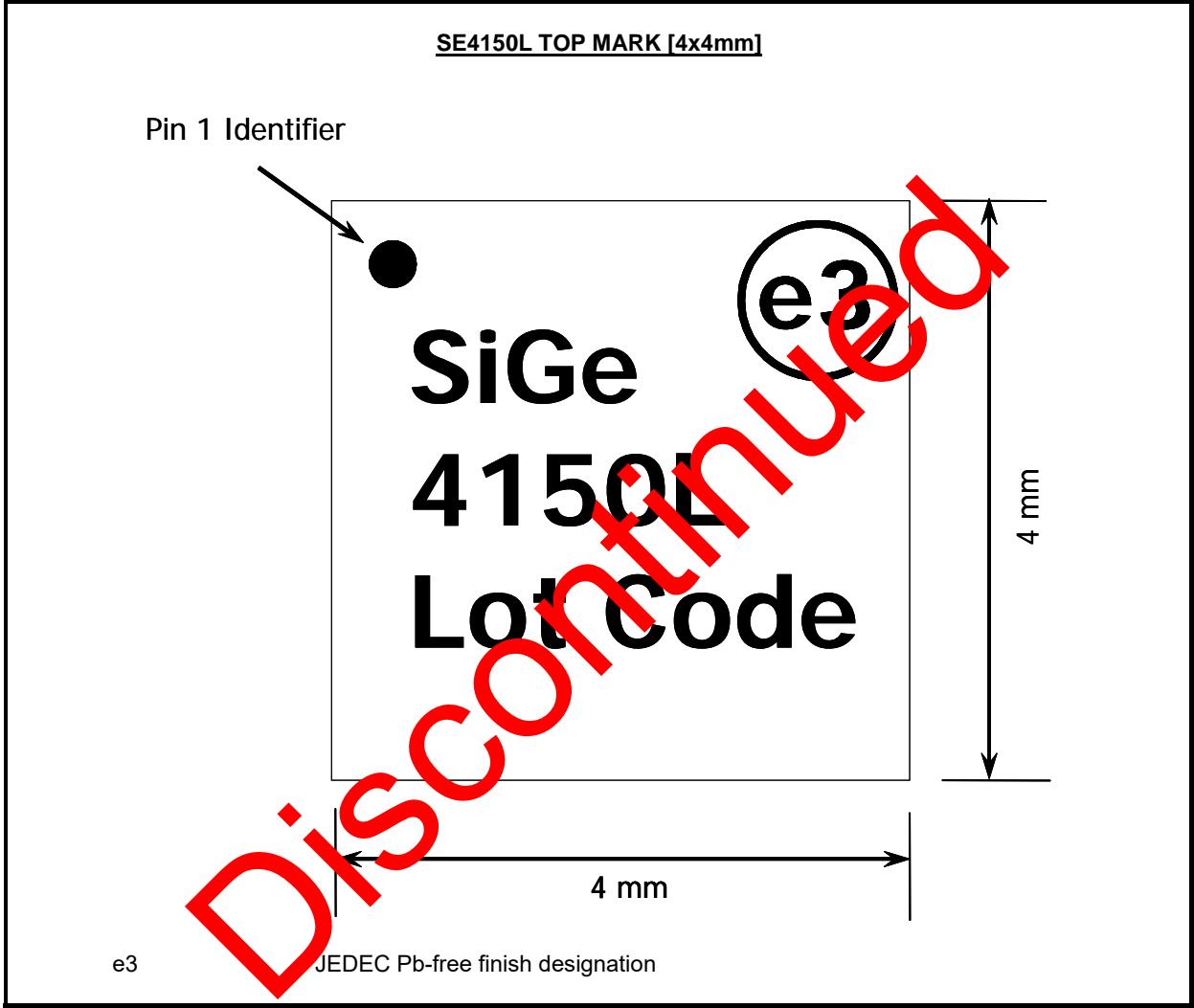



SKYWORKS®

DATA SHEET
SE4150L: GPS Receiver IC
Preliminary Datasheet

Copyright © 2012 Skyworks Solutions, Inc. All Rights Reserved.

Information in this document is provided in connection with Skyworks Solutions, Inc. ("Skyworks") products or services. These materials, including the information contained herein, are provided by Skyworks as a service to its customers and may be used for informational purposes only by the customer. Skyworks assumes no responsibility for errors or omissions in these materials or the information contained herein. Skyworks may change its documentation, products, services, specifications or product descriptions at any time, without notice. Skyworks makes no commitment to update its materials or information and shall have no responsibility whatsoever for conflicts, incompatibilities, or other difficulties arising from any future changes.

No license, whether express, implied, by estoppel or otherwise, is granted to any intellectual property rights by this document. Skyworks assumes no liability for any materials, products or information provided hereunder, including the sale, distribution, reproduction or use of Skyworks products, information or materials, except as may be provided in Skyworks Terms and Conditions of Sale.

THE MATERIALS, PRODUCTS AND INFORMATION ARE PROVIDED "AS IS" WITHOUT WARRANTY OF ANY KIND, WHETHER EXPRESS, IMPLIED, STATUTORY, OR OTHERWISE, INCLUDING FITNESS FOR A PARTICULAR PURPOSE OR USE, MERCHANTABILITY, PERFORMANCE, QUALITY OR NON-INFRINGEMENT OF ANY INTELLECTUAL PROPERTY RIGHT; ALL SUCH WARRANTIES ARE HEREBY EXPRESSLY DISCLAIMED. SKYWORKS DOES NOT WARRANT THE ACCURACY OR COMPLETENESS OF THE INFORMATION, TEXT, GRAPHICS OR OTHER ITEMS CONTAINED WITHIN THESE MATERIALS. SKYWORKS SHALL NOT BE LIABLE FOR ANY DAMAGES, INCLUDING BUT NOT LIMITED TO ANY SPECIAL, INDIRECT, INCIDENTAL, STATUTORY, OR CONSEQUENTIAL DAMAGES, INCLUDING WITHOUT LIMITATION, LOST REVENUES OR LOST PROFITS THAT MAY RESULT FROM THE USE OF THE MATERIALS OR INFORMATION, WHETHER OR NOT THE RECIPIENT OF MATERIALS HAS BEEN ADVISED OF THE POSSIBILITY OF SUCH DAMAGE.

Skyworks products are not intended for use in medical, lifesaving or life-sustaining applications, or other equipment in which the failure of the Skyworks products could lead to personal injury, death, physical or environmental damage. Skyworks customers using or selling Skyworks products for use in such applications do so at their own risk and agree to fully indemnify Skyworks for any damages resulting from such improper use or sale.

Customers are responsible for their products and applications using Skyworks products, which may deviate from published specifications as a result of design defects, errors, or operation of products outside of published parameters or design specifications. Customers should include design and operating safeguards to minimize these and other risks. Skyworks assumes no liability for applications assistance, customer product design, or damage to any equipment resulting from the use of Skyworks products outside of stated published specifications or parameters.

Skyworks, the Skyworks symbol, and "Breakthrough Simplicity" are trademarks or registered trademarks of Skyworks Solutions, Inc., in the United States and other countries. Third-party brands and names are for identification purposes only, and are the property of their respective owners. Additional information, including relevant terms and conditions, posted at www.skyworksinc.com, are incorporated by reference.

X-ON Electronics

Largest Supplier of Electrical and Electronic Components

Click to view similar products for [RF Receiver](#) category:

Click to view products by [Skyworks](#) manufacturer:

Other Similar products are found below :

[MICRF011YN](#) [TDA5240](#) [TDA5201XT](#) [TDA5225](#) [ATA8205P6C-TKQW](#) [VRC522](#) [MICRF229YQS](#) [SI4825-A10-CS](#) [SI4730-D60-GMR](#)
[MICRF219AAYQS](#) [AW13412DNR](#) [LT5504EMS8#PBF](#) [AD6677BCPZ](#) [AD6641BCPZ-500](#) [AD6643BCPZ-200](#) [AD6643BCPZ-250](#)
[AD6649BCPZ](#) [AD6649BCPZRL7](#) [AD6650ABC](#) [AD6652BBCZ](#) [AD6655ABCPZ-125](#) [AD6655ABCPZ-150](#) [AD6655ABCPZ-80](#)
[AD6657ABBCZ](#) [AD6657BBCZ](#) [AD6673BCPZ-250](#) [AD6674-1000EBZ](#) [AD6674BCPZ-1000](#) [AD6674BCPZ-500](#) [AD6676BCBZRL](#)
[AD6679BBPZ-500](#) [ADRV9008BBCZ-1](#) [AD9864BCPZ](#) [AD9864BCPZRL](#) [ADAR2004ACCZ](#) [AD9874ABST](#) [HMC8100LP6JE](#)
[LTC5556IUH#PBF](#) [BGT24MR2E6327XUMA1](#) [TDA5211](#) [MICRF011YM](#) [MAX7036GTP/V+](#) [MAX2141ETH/V+](#) [MAX7033EUI+](#)
[MAX1473EUI+T](#) [MAX1473EUI+](#) [MAX1470EUI+](#) [MAX7034AUI+](#) [MAX7034AUI/V+](#) [MAX7036GTP+](#)