

DATA SHEET
SE5503A: Dual Band 802.11a/b/g/n Wireless LAN Front-End

Applications

- IEEE802.11b DSSS WLAN
- IEEE802.11g OFDM WLAN
- IEEE802.11a OFDM WLAN
- IEEE802.11n WLAN
- Access Points, PCMCIA, PC cards

Features

- All RF ports matched to 50 Ω
- Integrated 2.4 GHz PA, 5 GHz PA, TX Filter, T/R switches and diplexers
- Integrated Power Detector for each TX Chain
- 21 dBm O/P Power, 802.11b, 11 Mbits, ACPR = 35 dBc
- 18 dBm @ 3.0 % EVM, 802.11g, 54 Mbits
- 16 dBm @ 3.0 % EVM, 802.11a, 54 Mbits
- Single supply voltage: 3.3 V ± 10 %
- Lead free, Halogen free, RoHS compliant, MSL 3
- 4mm x 4mm x 1.0mm, LGA Package

Ordering Information

Part No.	Package	Remark
SE5503A	24 pin LGA	Samples
SE5503A-R	24 pin LGA	Tape & Reel
SE5503A-EK1	N/A	Evaluation kit

Functional Block Diagram

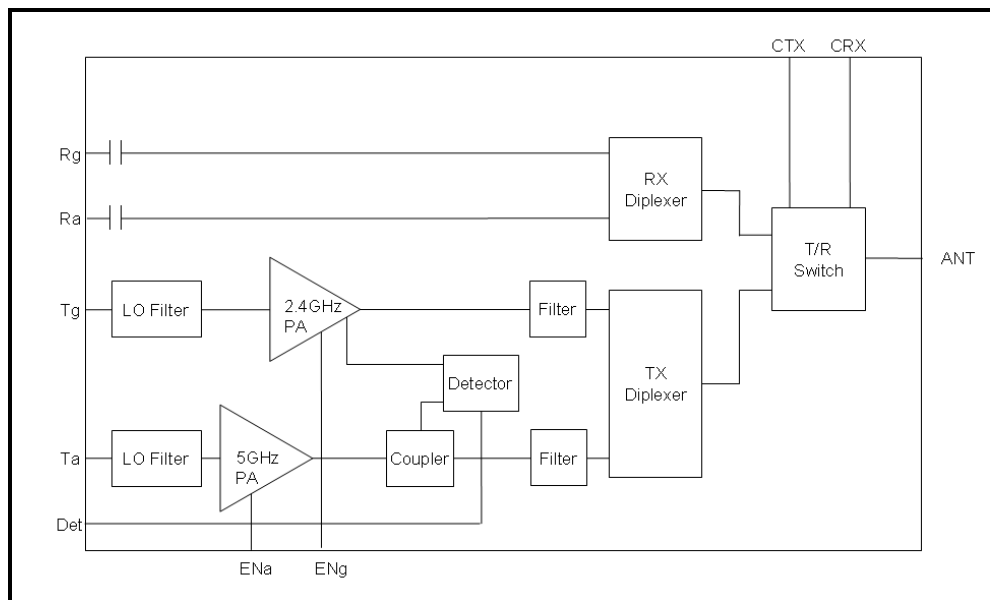

Product Description

The SE5503A is a complete 802.11a/b/g/n WLAN RF front-end module providing all the functionality of the power amplifiers, filtering, power detector, T/R switch, diplexers and associated matching. The SE5503A provides a complete 2.4 GHz and 5 GHz WLAN RF solution from the output of the transceiver to the antenna in an ultra compact form factor.

Designed for ease of use, all RF ports are matched to 50 Ω to simplify PCB layout and the interface to the transceiver RFIC. The SE5503A also includes a transmitter power detector with 20 dB of dynamic range for each transmit chain. Each power amplifier has a separate digital enable control for transmitter on/off control. The power ramp rise/fall time is less than 0.7 μsec.

The device also provides a notch filter from 3.260-3.267 GHz and 3.28-3.89 GHz prior to the input of each 2.4 GHz and 5 GHz power amplifiers, respectively.

The SE5503A packaged in 4mm x 4mm x 1.0mm, Halogen free, Lead free, ROHS compliant, MSL 3 LGA package.

DATA SHEET
SE5503A: Dual Band 802.11a/b/g/n Wireless LAN Front-End

Figure 1: SE5503A Functional Block Diagram

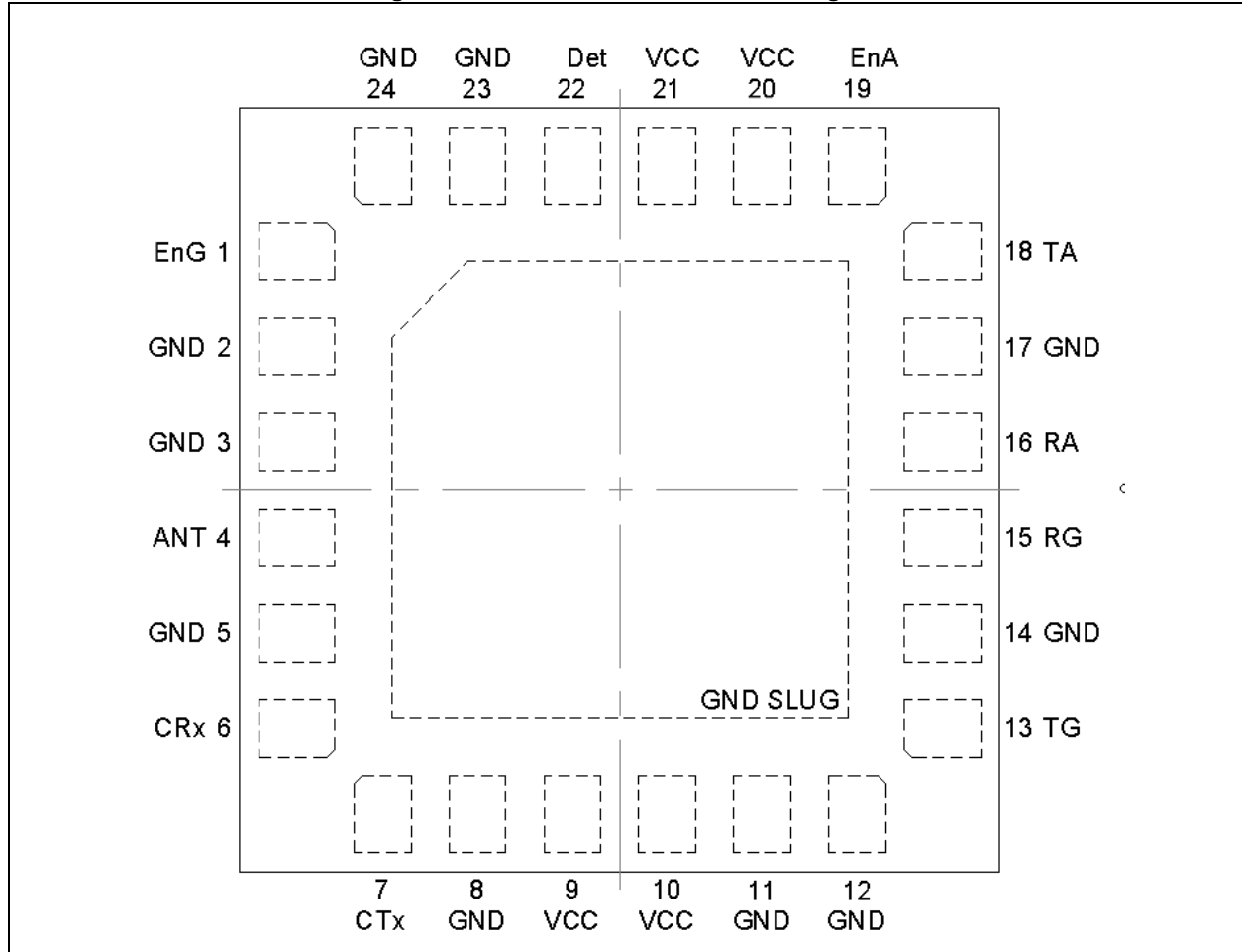

Figure 2: SE5503A Pin Out (Top View Through Package)

Pin Out Description

Pin No.	Name	Description
1	ENg	2.4 GHz Power Amplifier Enable
2	GND	Ground
3	GND	Ground
4	Ant	Antenna
5	GND	Ground
6	CRx	Switch Control for RX Path
7	CTx	Switch Control for TX Path
8	GND	Ground
9	VCC	Supply Voltage
10	VCC	Supply Voltage
11	GND	Ground
12	GND	Ground

Pin No.	Name	Description
13	Tg	2GHz Transmit RF Input
14	GND	Ground
15	Rg	2GHz Receive RF Output
16	Ra	5GHz Receive RF Output
17	GND	Ground
18	Ta	5GHz Transmit RF Input
19	ENa	5GHz Power Amplifier Enable
20	VCC	Supply Voltage
21	VCC	Supply Voltage
22	DET	2/5GHz Power Detector Output
23	GND	Ground
24	GND	Ground

DATA SHEET
SE5503A: Dual Band 802.11a/b/g/n Wireless LAN Front-End

Absolute Maximum Ratings

These are stress ratings only. Exposure to stresses beyond these maximum ratings may cause permanent damage to, or affect the reliability of the device. Avoid operating the device outside the recommended operating conditions defined below. This device is ESD sensitive. Handling and assembly of this device should be at ESD protected workstations.

Symbol	Definition	Min.	Max.	Unit
V _{CC}	Supply Voltage	-0.3	3.6	V
PU	ENa, ENg	-0.3	3.6	V
TX _{RF}	Ta, Tg, ANT terminated in 6:1 load or better	-	12.0	dBm
T _A	Operating Temperature Range	-10	85	°C
T _{STG}	Storage Temperature Range	-40	150	°C
ESD _{HBM}	JEDEC JESD22-A114 all pins	-	250	V

Recommended Operating Conditions

Symbol	Parameter	Min.	Typ.	Max.	Unit
V _{CC}	Supply Voltage	3.0	3.3	3.6	V
T _A	Ambient Temperature	-10	25	85	°C

DC Electrical Characteristics

Conditions: V_{CC} = 3.3 V, T_A = 25 °C, as measured on Skyworks Solutions' SE5503A-EV1 evaluation board (de-embedded to device), all unused ports terminated with 50 ohms, unless otherwise noted

Symbol	Parameter	Conditions	Min.	Typ.	Max.	Unit
I _{CC-G}	Total 802.11g Transmit Supply Current	P _{OUT} = 18 dBm, 54 Mbps OFDM signal, 64 QAM ENg = 3.3 V, ENa = 0 V	-	150	180	mA
I _{CC-B}	Total 802.11b Transmit Supply Current	P _{OUT} = 21 dBm, 11 Mbps CCK signal, BT = 0.45, ENg = 3.3 V, ENa = 0 V	-	190	200	mA
I _{CC-A}	Total 802.11a Transmit Supply Current	P _{OUT} = 16 dBm, 54 Mbps OFDM signal, 64 QAM, ENa = 3.3 V, ENg = 0 V	-	220	250	mA
I _{CC_OFF}	Total Supply Current	No RF, ENg = ENa = 0 V	-	65	200	µA

DATA SHEET
SE5503A: Dual Band 802.11a/b/g/n Wireless LAN Front-End

Logic Characteristics

Conditions: $V_{CC} = 3.3\text{ V}$, $T_A = 25\text{ }^\circ\text{C}$, as measured on Skyworks Solutions' SE5503A-EV1 evaluation board (de-embedded to device), all unused ports terminated with 50 ohms, unless otherwise noted.

Symbol	Parameter	Conditions	Min.	Typ.	Max.	Unit
V_{ENH}	Logic High Voltage for ENg, ENa (Module On)	-	1.8	-	V_{CC}	V
V_{ENL}	Logic Low Voltage ENg, ENa (Module Off)	-	0	-	0.5	V
I_{ENH}	Input Current Logic High Voltage (ENg, ENa)	-	-	350	400	μA
I_{ENL}	Input Current Logic Low Voltage (ENg, ENa)	-	-	0.2	-	μA

Switch Characteristics

Conditions: $V_{CC} = V_{EN} = 3.3\text{ V}$, $T_A = 25\text{ }^\circ\text{C}$, as measured on Skyworks Solutions' SE5503A-EV1 evaluation board (de-embedded to device), all unused ports terminated with 50 ohms, unless otherwise noted.

Symbol	Parameter	Conditions	Min.	Typ.	Max.	Unit
V_{CTL_ON}	Control Voltage (On State)	-	3.0	-	3.6	V
V_{CTL_OFF}	Control Voltage (OFF State)	-	0.0	-	0.2	V
SW_{ON}	Low Loss Switch Control Voltage	High State = $V_{CTL_ON} - V_{CTL_OFF}$	2.8	-	V_{CC}	V
SW_{OFF}	High Loss Switch Control Voltage	Low State = $V_{CTL_OFF} - V_{CTL_OFF}$	0	-	0.3	V
I_{CTL_ON}	Switch Control Bias Current (RF Applied)	On pin (CTx, CRx) being driven high. RF Applied	-	-	100	μA
I_{CTL_ON}	Switch Control Bias Current (No RF)	On pin (CTx, CRx) being driven high. No RF	-	-	30	μA
C_{CTL}	Control Input Capacitance	-	-	-	100	pF

Switch Control Logic Table

CTx	CRx	Tg, Ta – ANT	Rg, Ra – ANT
SW_{ON}	SW_{OFF}	ON	OFF
SW_{OFF}	SW_{ON}	OFF	ON
SW_{OFF}	SW_{OFF}	OFF	OFF
All Other States		Unsupported Switch State	

DATA SHEET
SE5503A: Dual Band 802.11a/b/g/n Wireless LAN Front-End
2.4 GHz AC Electrical Characteristics
2.4 GHz Transmit Characteristics

Conditions: $V_{CC} = 3.3\text{ V}$, $ENG = CTx = 3.3\text{ V}$, $ENa = CRx = 0\text{ V}$, $T_A = 25\text{ }^\circ\text{C}$, as measured on Skyworks Solutions' SE5503A-EV1 evaluation board, all unused ports terminated with 50 ohms, unless otherwise noted.

Symbol	Parameter	Condition	Min.	Typ.	Max.	Unit
F_{IN}	Frequency Range	-	2400	-	2500	MHz
$P_{802.11g}$	Output power	54 Mbps OFDM signal, 64QAM, EVM = 3.0 %, input signal EVM < 1%	17.25	18	-	dBm
$P_{802.11b}$	Output power	11 Mbps CCK signal, BT = 0.45 ACPR($\pm 11\text{MHz}$ offset) < -35 ACPR($\pm 22\text{MHz}$ offset) < -56	-	21	-	dBm
P_{1dB}	P1dB	-	24	24.5	-	dBm
S_{21}	Small Signal Gain	-	25	-	30	dB
ΔS_{21}	Small Signal Gain Variation Over Band	-	-	1.0	2.0	dB
$S_{21}1.6$	Gain at $\frac{1}{2}\text{Ref-VCO}$	1640.00 to 1942.00 MHz	-	12	20	dB
$S_{21}3.2$	Gain at Ref-VCO	3216.00 to 3312.00 MHz	-	-	0	dB
2f,3f	Harmonics	$P_{out} \leq 21\text{ dBm}$, 1Mbps, CCK	-	-	-45.2	dBm/MHz
t_{dr}, t_{df}	Delay and rise/fall Time	50 % of V_{EN} edge and 90/10 % of final output power level	-	0.25	0.4	μs
S_{11}	Input Return Loss	-	8	10	-	dB
STAB	Stability	CW, $P_{OUT} = 21\text{ dBm}$ 0.1 GHz – 21 GHz Load VSWR = 6:1	All non-harmonically related outputs less than -42 dBm/MHz			
R_u	Ruggedness	$T_g = 12\text{ dBm}$, ANT load varies over 6:1 VSWR	No Irreversible damage			

DATA SHEET
SE5503A: Dual Band 802.11a/b/g/n Wireless LAN Front-End

2.4 GHz Receive Characteristics

Conditions: $V_{CC} = 3.3\text{ V}$, $CR_x = 3.3\text{ V}$, $EN_g = EN_a = CT_x = 0\text{ V}$, $T_A = 25\text{ }^\circ\text{C}$, as measured on Skyworks Solutions' SE5503A-EV1 evaluation board (de-embedded to device), all unused ports terminated with 50 ohms, unless otherwise noted.

Symbol	Parameter	Condition	Min.	Typ.	Max.	Unit
F _{OUT}	Frequency Range	-	2400	-	2500	MHz
RX _{IL}	Insertion Loss	-	-	1.5	-	dB
RX _{RL}	Return Loss	-	10	15	-	dB
TR _{ISOL-2}	Rx Leakage	CT _x = SWON, CR _x = SWOFF, Device transmitting (TXEN = 3.3 V) 18.0 dBm @ ANT, Power measured @ RX_OUT	-	-	-3	dBm
ANTR _{ISOL}	Antenna to Rx isolation	Small signal input into ANT, Device not transmitting, Power measured @ RX _{RF} , CT _x (Ant to Rx Iso) = SWON, CR _x = SWOFF	20	-	33	dB

DATA SHEET
SE5503A: Dual Band 802.11a/b/g/n Wireless LAN Front-End

5 GHz AC Electrical Characteristics

5 GHz Transmit Characteristics

Conditions: $V_{CC} = 3.3\text{ V}$, E_{NA} and $CTx = 3.3\text{ V}$, $E_{NG} = CRx = 0\text{ V}$, $T_A = 25\text{ }^\circ\text{C}$, as measured on Skyworks Solutions' SE5503A-EV1 evaluation board, all unused ports terminated with 50 ohms, unless otherwise noted.

Symbol	Parameter	Condition	Min.	Typ.	Max.	Unit
F_{IN}	Frequency Range	-	4900	-	5900	MHz
$P_{802.11a}$	Nominal Output Power	54 Mbps OFDM signal, 64 QAM, EVM = 3.0 %, input signal EVM < 1%	15.0	16.0	-	dBm
P_{1dB}	P1dB	-	21	22.5	-	dBm
S_{21}	Small Signal Gain	-	23	-	30	dB
ΔS_{21}	Small Signal Gain Variation Over 40 MHz Channel		-	-	0.5	dB
	Small Signal Gain Variation Over sub-bands	4.9 – 5.18 GHz 5.18 – 5.50 GHz 5.50 – 5.90 GHz	-	1	3	dB
$S_{213.2}$	Gain at Ref-VCO	3280 to 3885 MHz	-	2	5.5	dB
2f,3f	Harmonics @ 16dBm, 54Mbps, 802.11a	4900 – 5900 MHz	-	-	-48.2	dBm/MHz
t_{dr}, t_{df}	Delay and rise/fall Time	50 % of V_{EN} edge and 90/10 % of final output power level	-	0.25	0.4	μs
S_{11}	Input Return Loss	-	9	15	-	dB
STAB	Stability	64 QAM, $P_{OUT} = 16\text{ dBm}$ 0.1 GHz – 21 GHz Load VSWR = 6:1	All non-harmonically related outputs less than -42 dBm/MHz			
R_u	Ruggedness	$TXa = 12\text{ dBm}$, ANT load varies over 6:1 VSWR	No Irreversible damage			

DATA SHEET
SE5503A: Dual Band 802.11a/b/g/n Wireless LAN Front-End

5 GHz Receive Characteristics

Conditions: $V_{CC} = 3.3\text{ V}$, $CR_x = 3.3\text{ V}$, $ENG = EN_a = CT_x = 0\text{ V}$, $T_A = 25\text{ }^\circ\text{C}$, as measured on Skyworks Solutions' SE5503A-EV1 evaluation board (de-embedded to device), all unused ports terminated with 50 ohms, unless otherwise noted.

Symbol	Parameter	Condition	Min.	Typ.	Max.	Unit
F _{OUT}	Frequency Range	-	4900	-	5900	MHz
RX _{IL}	Insertion Loss	-	-	1.8	-	dB
RX _{RL}	Return Loss	-	10	15	-	dB
T _{ALEAK}	Tx Power Leakage	P _{out} = 16 dBm, EN _a = 3.3 V, CT _x = 3.3 V, CR _x = 0 V	-	-	-3	dBm
ATT _a	Antenna to Rx isolation	Small signal input into ANT, Device not transmitting, Power measured @ RX _{RF} , CT _x (Ant to Rx Iso) = SWON, CR _x = SWOFF	19	-	33	dB

DATA SHEET
SE5503A: Dual Band 802.11a/b/g/n Wireless LAN Front-End

2.4 GHz Power Detector Characteristic

Conditions: $V_{CC} = E_{NG} = C_{TX} = 3.3\text{ V}$, $E_{NA} = C_{RX} = 0\text{ V}$, $T_A = 25\text{ }^\circ\text{C}$, as measured on Skyworks Solutions' SE5503A-EV1 evaluation board (de-embedded to device), all unused ports terminated with $50\ \Omega$, unless otherwise noted.

Symbol	Parameter	Condition	Min.	Typ.	Max.	Unit
F _{OUT}	Frequency Range	-	2400	-	2500	MHz
PDR	Power detect range, peak power	Measured at ANT	0	-	22	dBm
PDZ _{OUT}	DC Output impedance	-	-	2.3	-	K Ω
PDV _{P21}	Output Voltage, P _{OUT} = 21dBm	Measured into 26.5K Ω	0.75	0.85	1.0	V
PDV _{P18}	Output Voltage, P _{OUT} = 18dBm	Measured into 26.5K Ω	0.56	0.63	0.73	V
PDV _{pnoRF}	Output Voltage, P _{OUT} = No RF	Measured into 26.5K Ω	0.29	0.31	0.33	V
LPF _{-3dB}	Power detect low pass filter -3dB corner frequency	Measured into 26.5K Ω	-	2.0	-	MHz

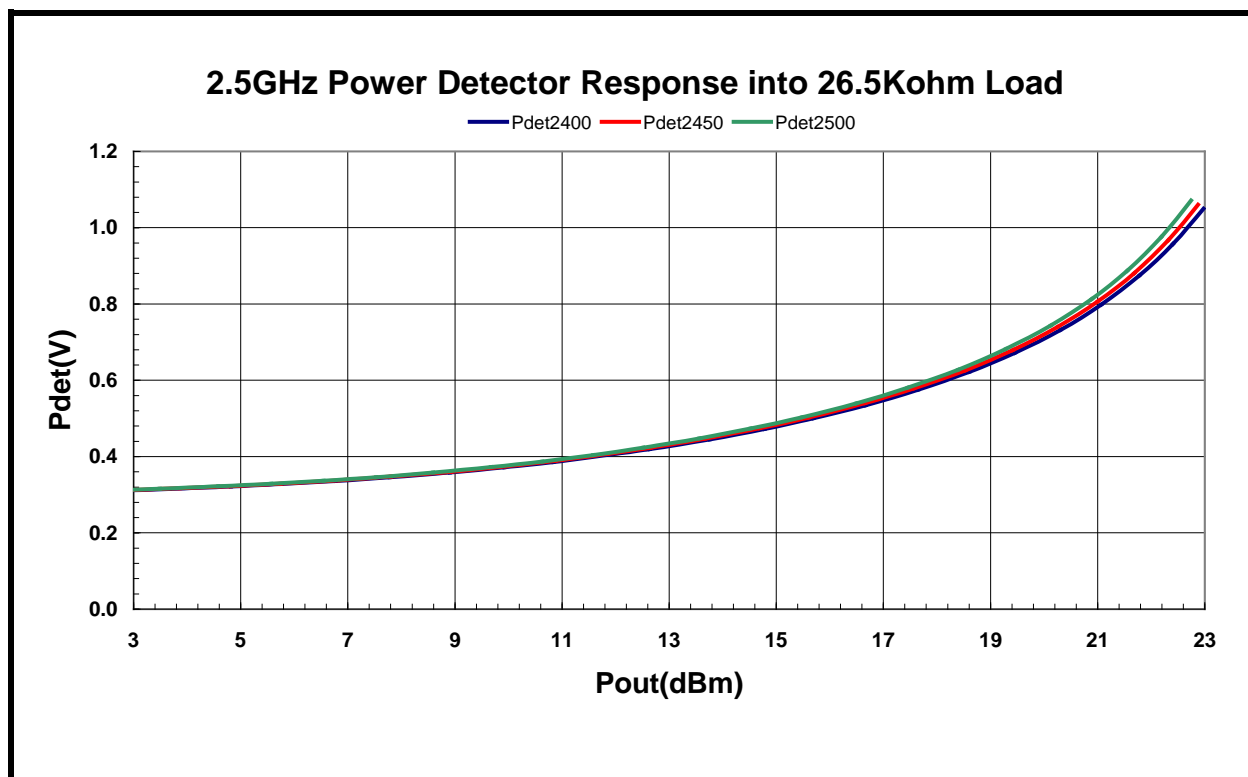

Figure 3: SE5503A Power Detector vs. Output Power over Frequency (CW Signal)

DATA SHEET
SE5503A: Dual Band 802.11a/b/g/n Wireless LAN Front-End

5 GHz Power Detector Characteristic

Conditions: $V_{CC} = ENa = CTx = 3.3\text{ V}$, $ENg = CRx = 0\text{ V}$, $T_A = 25\text{ }^\circ\text{C}$, as measured on Skyworks Solutions' SE5503A-EV1 evaluation board (de-embedded to device), all unused ports terminated with 50 Ω , unless otherwise noted.

Symbol	Parameter	Condition	Min.	Typ.	Max.	Unit
F _{OUT}	Frequency Range	-	4900	-	5900	MHz
PDR	Power detect range, peak power	Measured at ANT	0	-	21	dBm
PDZ _{OUT}	DC Output impedance	-	-	26.5	-	K Ω
PDV _{p18}	Output Voltage, P _{OUT} = 18dBm	Measured into 26.5K Ω	0.6	0.75	0.9	V
PDV _{p16}	Output Voltage, P _{OUT} = 16dBm	Measured into 26.5K Ω	0.5	0.65	0.85	V
PDV _{NoRF}	Output Voltage, P _{OUT} = No RF	Measured into 26.5K Ω	0.29	0.31	0.33	V
LPF _{-3dB}	Power detect low pass filter -3dB corner frequency	Measured into 26.5K Ω	-	2.0	-	MHz

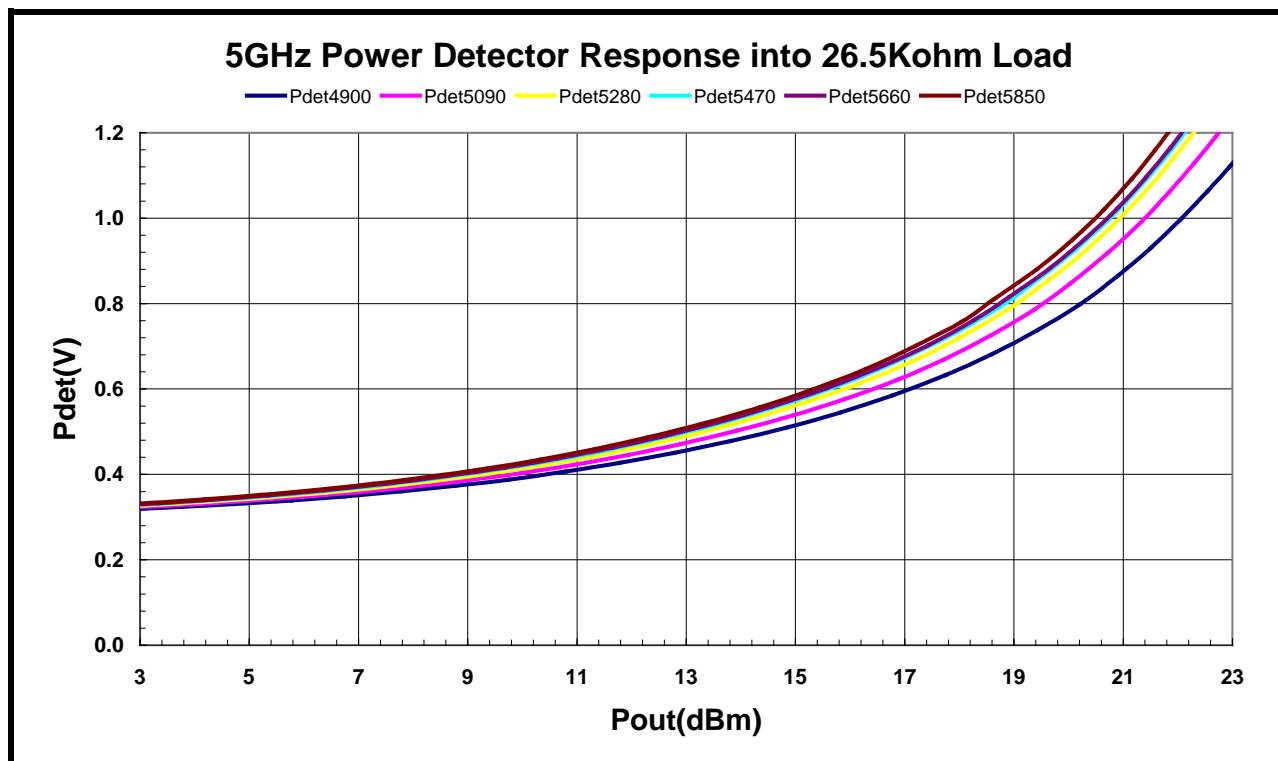
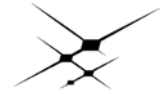

Figure 4: Preliminary SE5503A Power Detector vs. Output Power over Frequency (CW Signal)



DATA SHEET
SE5503A: Dual Band 802.11a/b/g/n Wireless LAN Front-End

Recommended Land and Solder Patterns

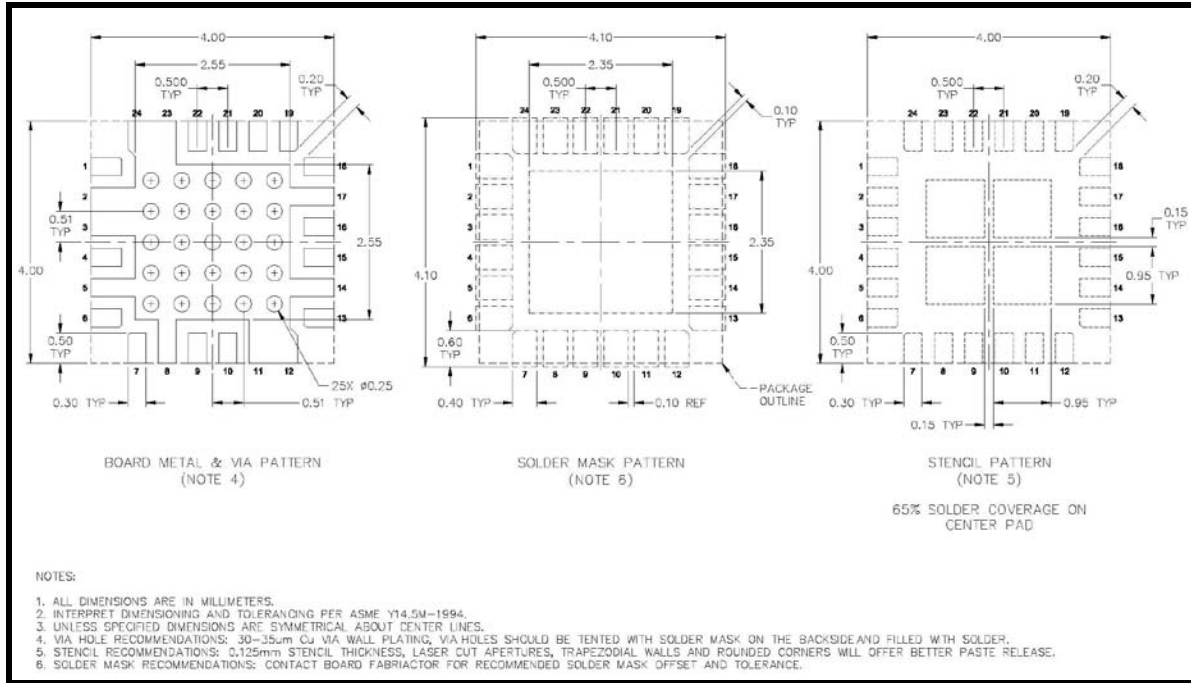

Figure 6: Recommended Land and Solder Patterns

DATA SHEET
SE5503A: Dual Band 802.11a/b/g/n Wireless LAN Front-End

Package Handling Information

Because of its sensitivity to moisture absorption, instructions on the shipping container label must be followed regarding exposure to moisture after the container seal is broken, otherwise, problems related to moisture absorption may occur when the part is subjected to high temperature during solder assembly. The SE5503A is capable of withstanding a Pb free solder reflow. Care must be taken when attaching this product, whether it is done manually or in a production solder reflow environment. If the part is manually attached, precaution should be taken to insure that the device is not subjected to temperatures above its rated peak temperature for an extended period of time. For details on both attachment techniques, precautions, and handling procedures recommended, please refer to:

- “Land Grid Array Module Solder Reflow & Rework Information”, *Document Number QAD-00046*.
- “Handling, Packing, Shipping and Use of Moisture Sensitive LGA”, *Document Number QAD-00047*.



Caution! Class 1A ESD sensitive device

Product Branding

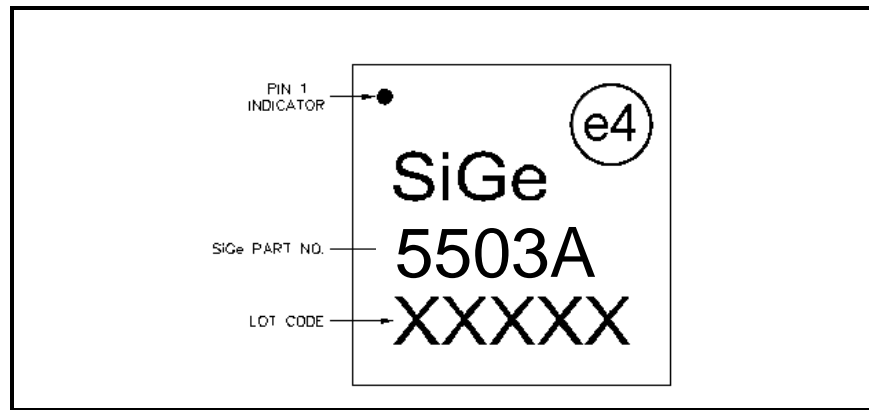

Figure 7: SE5503A Branding Information

DATA SHEET
SE5503A: Dual Band 802.11a/b/g/n Wireless LAN Front-End

Tape and Reel Information

Production quantities of this product are shipped in a standard tape-and-reel format. Specific tape and reel dimensions and sizing is shown in Table 1 and Figure .

Parameter	Value
Devices Per Reel	3000
Reel Diameter	13 inches

Table 1: Tape and Reel Dimensions

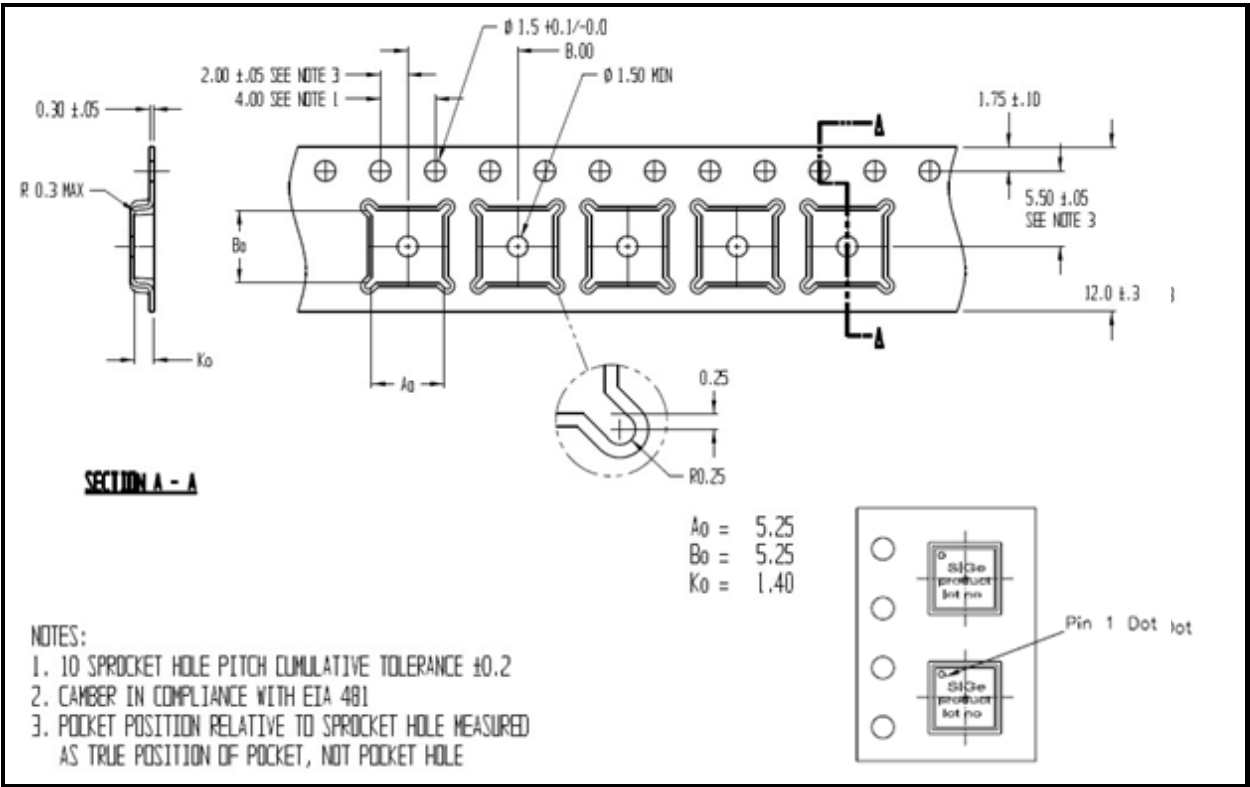

Figure 8: Detailed Tape and Reel Information (All dimensions in Millimeters)



DATA SHEET
SE5503A: Dual Band 802.11a/b/g/n Wireless LAN Front-End

Document Change History

Revision	Date	Notes
1.0	Sep-01-2009	Created
1.1	Sep-18-2009	Added Recommended Land Pattern
1.2	Sep-22-2009	Updated recommended land pattern
1.3	Nov-13-2009	Updated ICC, S ₂₁ , RX _{IL} , RX _{RL} , ICC.
1.4	Dec-1-2009	Updated operating temp, rise-fall time, and 5GHz sub-bands.
1.5	Mar-23-2010	Updated 5GHz harmonic compliance, absolute max operating temp, off-state leakage current
1.6	Oct-27-2010	Updated Package Marking Diagram
1.7	Feb-9-2011	Updated ESD rating Added min/max limits
1.8	Apr-03-2012	Updated with Skyworks logo and disclaimer statement

Copyright © 2012 Skyworks Solutions, Inc. All Rights Reserved.

Information in this document is provided in connection with Skyworks Solutions, Inc. ("Skyworks") products or services. These materials, including the information contained herein, are provided by Skyworks as a service to its customers and may be used for informational purposes only by the customer. Skyworks assumes no responsibility for errors or omissions in these materials or the information contained herein. Skyworks may change its documentation, products, services, specifications or product descriptions at any time, without notice. Skyworks makes no commitment to update the materials or information and shall have no responsibility whatsoever for conflicts, incompatibilities, or other difficulties arising from any future changes.

No license, whether express, implied, by estoppel or otherwise, is granted to any intellectual property rights by this document. Skyworks assumes no liability for any materials, products or information provided hereunder, including the sale, distribution, reproduction or use of Skyworks products, information or materials, except as may be provided in Skyworks Terms and Conditions of Sale.

THE MATERIALS, PRODUCTS AND INFORMATION ARE PROVIDED "AS IS" WITHOUT WARRANTY OF ANY KIND, WHETHER EXPRESS, IMPLIED, STATUTORY, OR OTHERWISE, INCLUDING FITNESS FOR A PARTICULAR PURPOSE OR USE, MERCHANTABILITY, PERFORMANCE, QUALITY OR NON-INFRINGEMENT OF ANY INTELLECTUAL PROPERTY RIGHT; ALL SUCH WARRANTIES ARE HEREBY EXPRESSLY DISCLAIMED. SKYWORKS DOES NOT WARRANT THE ACCURACY OR COMPLETENESS OF THE INFORMATION, TEXT, GRAPHICS OR OTHER ITEMS CONTAINED WITHIN THESE MATERIALS. SKYWORKS SHALL NOT BE LIABLE FOR ANY DAMAGES, INCLUDING BUT NOT LIMITED TO ANY SPECIAL, INDIRECT, INCIDENTAL, STATUTORY, OR CONSEQUENTIAL DAMAGES, INCLUDING WITHOUT LIMITATION, LOST REVENUES OR LOST PROFITS THAT MAY RESULT FROM THE USE OF THE MATERIALS OR INFORMATION, WHETHER OR NOT THE RECIPIENT OF MATERIALS HAS BEEN ADVISED OF THE POSSIBILITY OF SUCH DAMAGE.

Skyworks products are not intended for use in medical, lifesaving or life-sustaining applications, or other equipment in which the failure of the Skyworks products could lead to personal injury, death, physical or environmental damage. Skyworks customers using or selling Skyworks products for use in such applications do so at their own risk and agree to fully indemnify Skyworks for any damages resulting from such improper use or sale.

Customers are responsible for their products and applications using Skyworks products, which may deviate from published specifications as a result of design defects, errors, or operation of products outside of published parameters or design specifications. Customers should include design and operating safeguards to minimize these and other risks. Skyworks assumes no liability for applications assistance, customer product design, or damage to any equipment resulting from the use of Skyworks products outside of stated published specifications or parameters.

Skyworks, the Skyworks symbol, and "Breakthrough Simplicity" are trademarks or registered trademarks of Skyworks Solutions, Inc., in the United States and other countries. Third-party brands and names are for identification purposes only, and are the property of their respective owners. Additional information, including relevant terms and conditions, posted at www.skyworksinc.com, are incorporated by reference.

X-ON Electronics

Largest Supplier of Electrical and Electronic Components

Click to view similar products for [RF Front End](#) category:

Click to view products by [Skyworks](#) manufacturer:

Other Similar products are found below :

[SE2622L-R](#) [BGM1032N7E6327XUSA1](#) [LX5586LL](#) [SKY85703-11](#) [LX5586HLL](#) [LX5586ALL](#) [SKY66111-21](#) [SKY65728-11](#) [SKY68000-31](#)
[SKY85308-11](#) [SKY85302-11](#) [SKY65724-11](#) [ADTR1107ACCZ](#) [LMP91051MTX/NOPB](#) [SE5501L-R](#) [QPF4519SR](#) [SE5503A-R](#)
[ADA8282WBCPZ](#) [ADRF5545ABCPZN](#) [ADRF5545ABCPZN-R7](#) [AD8283WBCPZ](#) [AD8284WCSVZ](#) [ADRF5547BCPZN](#)
[ADRF5547BCPZN-R7](#) [ADRF5549BCPZN](#) [ADRF5549BCPZN-R7](#) [HV7350K6-G](#) [SE5516A-R](#) [MCP2030-I/SL](#) [MAX2009ETI+](#)
[MAX2078CTK+](#) [MAX2335ETI+](#) [MAX2678GTB/V+T](#) [MD2131K7-G](#) [MD2134K7-G](#) [RFFM6903TR13](#) [HV7351K6-G](#) [MCP2035-I/ST](#)
[SE2614BT-R](#) [SE2438T-R](#) [SST12LF02-QXCE](#) [SST12LF09-Q3CE](#) [RFX2401C](#) [RFX2402E](#) [SKY85201-11](#) [RFFM4591FTR7](#) [RFFM8211TR7](#)
[RFFM4293TR7](#) [RFFM4203TR7](#) [RFFM5765QTR7](#)