

DATA SHEET

SKY12146-321LF: 3.0 – 3.8 GHz, 20 dB Variable Voltage Attenuator

Applications

- WLANs
- WiMAX systems

Features

- Power control for 3.5 GHz fixed wireless applications
- Typical attenuation: 20 dB
- Control voltage: 0 to 1.4 V
- Low cost
- No external components needed
- Small, QFN (12-pin, 3 x 3 mm) package (MSL1, 260 °C per JEDEC J-STD-020)



Skyworks Green™ products are compliant with all applicable legislation and are halogen-free. For additional information, refer to *Skyworks Definition of Green™*, document number SQ04-0074.

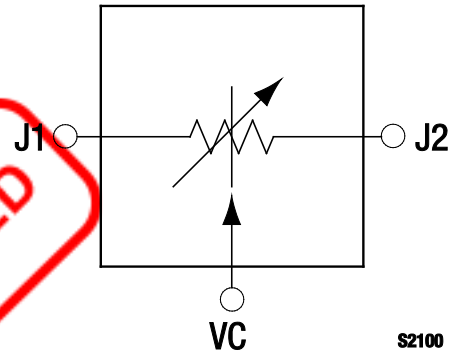
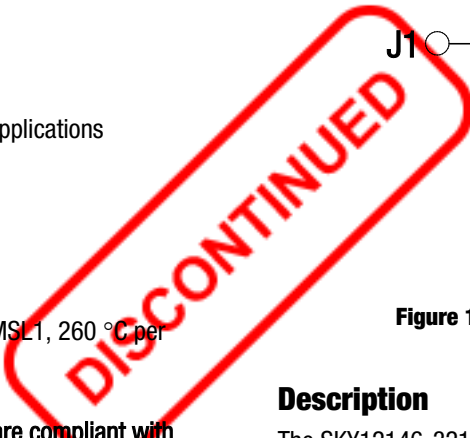

Figure 1. SKY12146-321LF Block Diagram

Description

The SKY12146-321LF is a GaAs pHEMT variable voltage attenuator designed for WLAN and WiMAX applications. The device operates within 3.2 to 3.8 GHz and is ideal for low-cost applications such as 3.5 GHz fixed wireless LANs and WiMAX power control systems.

The SKY12146-321LF is provided in a 12-pin, 3 x 3 mm Quad Flat No-Lead (QFN) package.

A functional block diagram is shown in Figure 1. The pin configuration and package are shown in Figure 2. Signal pin assignments and functional pin descriptions are provided in Table 1.

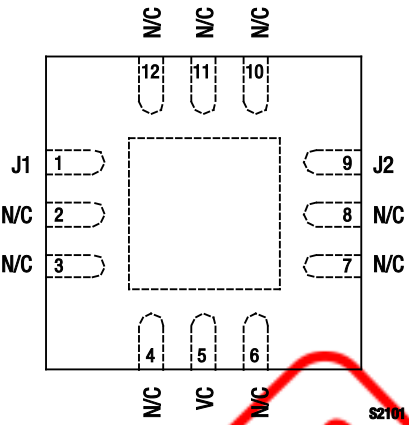

Figure 2. SKY12146-321LF Pinout – 12-Pin QFN (Top View)

Table 1. SKY12146-321LF Signal Descriptions

Pin #	Name	Description	Pin #	Name	Description
1	J1	RF input/output	7	N/C	No connection
2	N/C	No connection	8	N/C	No connection
3	N/C	No connection	9	J2	RF input/output
4	N/C	No connection	10	N/C	No connection
5	VC	Voltage control	11	N/C	No connection
6	N/C	No connection	12	N/C	No connection

Note: Exposed pad must be grounded. N/C pins may be grounded with no change in performance.

Table 2. SKY12146-321LF Absolute Maximum Ratings

Parameter	Symbol	Minimum	Typical	Maximum	Units
RF input power	P_{IN}			+30	dBm
Control voltage	V_{CTL}	-0.5		+6.0	V
Operating temperature	T_{OP}	-40		+85	°C
Storage temperature	T_{STG}	-65		+150	°C

Note: Exposure to maximum rating conditions for extended periods may reduce device reliability. There is no damage to device with only one parameter set at the limit and all other parameters set at or below their nominal value. Exceeding any of the limits listed here may result in permanent damage to the device.

CAUTION: Although this device is designed to be as robust as possible, Electrostatic Discharge (ESD) can damage this device. This device must be protected at all times from ESD. Static charges may easily produce potentials of several kilovolts on the human body or equipment, which can discharge without detection. Industry-standard ESD precautions should be used at all times.

Technical Description

The SKY12146-321LF Variable Voltage Attenuator uses GaAs pHEMTs as voltage-controlled attenuating elements. To maintain impedance matching within operating frequencies, the GaAs pHEMTs are coupled to the RF input and output through an integrated hybrid-coupler. Since no temperature compensation is used in this product, the attenuation value at any fixed bias voltage varies with operating temperature.

Electrical and Mechanical Specifications

The absolute maximum ratings of the SKY12146-321LF are provided in Table 2. Electrical specifications are provided in Table 3.

Typical performance characteristics of the SKY12146-321LF are illustrated in Figures 3 through 8.

Table 3. SKY12146-321LF Electrical Specifications (Note 1)
(TOP = 25 °C, Characteristic Impedance [Z₀] = 50 Ω, Unless Otherwise Noted)

Parameter	Symbol	Test Condition	Min	Typical	Max	Units
Insertion loss	IL	VC = 1.4 V				
		2.7 to 3.2 GHz		1.4		dB
		3.2 to 3.8 GHz		1.5	1.8	dB
		3.8 to 4.0 GHz		1.6		dB
Attenuation	Attn	VC = 0 V				
		2.7 to 3.2 GHz		20.0		dB
		3.2 to 3.8 GHz	18.0	20.0		dB
		3.8 to 4.0 GHz		20.5		dB
Return loss	IS111	2.7 to 3.2 GHz		12		dB
		3.2 to 3.8 GHz	11	14		dB
		3.8 to 4.0 GHz		27		dB
Switching characteristics: Rise, fall On, off Video feedthrough		10/90% or 90/10% RF		50		ns
		50% V _{ctrl} to 90/10% RF		150		ns
		T _{rise} = 1 ns, bandwidth = 500 MHz		25		mV
Maximum input power for <1 dB attenuation variation	P _{IN}	3.2 to 3.8 GHz		+13		dBm
3 rd Order Input Intercept Point	IIP3	3.2 to 3.8 GHz		+20		dBm
Control voltage	V _{CTL}		0		1.4	V
Control current	I _{CTL}			5		μA

Note 1: Performance is guaranteed only under the conditions listed in this Table.

Typical Performance Characteristics

(TOP = 25 °C, Characteristic Impedance [Z₀] = 50 Ω, Unless Otherwise Noted)

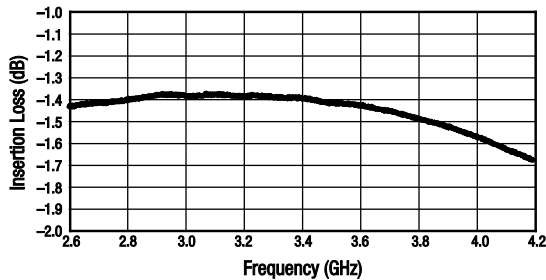

Figure 3. Typical Insertion Loss (VC = 1.4 V)

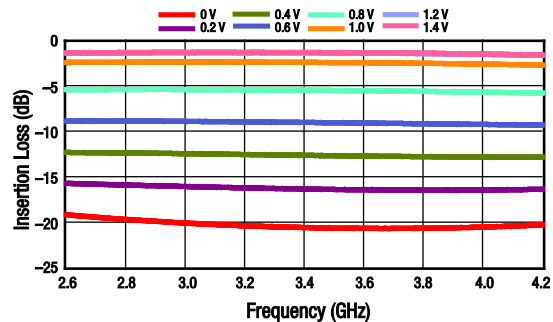

Figure 4. Typical Insertion Loss vs VC

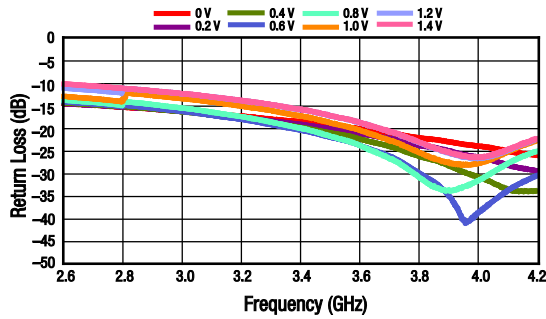

Figure 5. Typical Input Return Loss vs VC

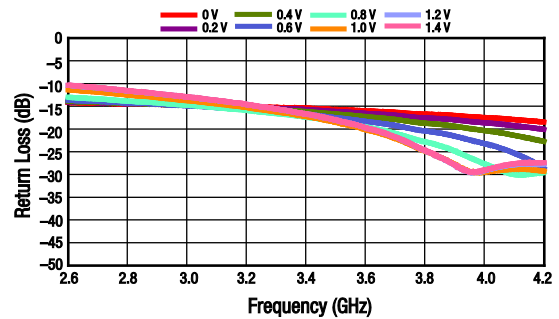

Figure 6. Typical Output Return Loss vs VC

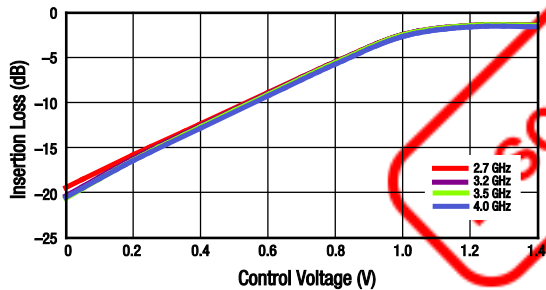

Figure 7. Typical Loss vs Control Voltage

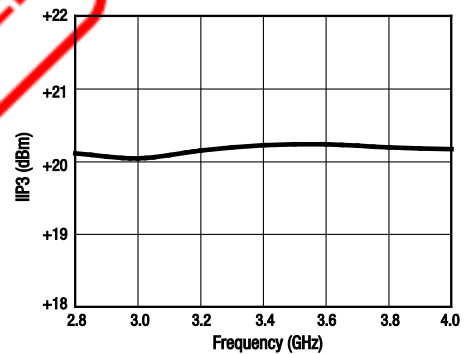

Figure 8. IIP3 vs Frequency

Evaluation Board Description

The SKY12146-321LF Evaluation Board is used to test the performance of the SKY12146-321LF attenuator. An assembly drawing for the Evaluation Board is shown in Figure 9 and an Evaluation Board schematic diagram is shown in Figure 10.

Package Dimensions

The PCB layout footprint for the SKY12146-321LF is shown in Figure 11. Typical case markings are noted in Figure 12. Package dimensions for the 12-pin QFN are shown in Figure 13, and tape and reel dimensions are provided in Figure 14.

Package and Handling Information

Instructions on the shipping container label regarding exposure to moisture after the container seal is broken must be followed. Otherwise, problems related to moisture absorption may occur when the part is subjected to high temperature during solder assembly.

THE SKY12146-321LF is rated to Moisture Sensitivity Level 1 (MSL1) at 260 °C. It can be used for lead or lead-free soldering. For additional information, refer to the Skyworks Application Note, *Solder Reflow Information*, document number 200164.

Care must be taken when attaching this product, whether it is done manually or in a production solder reflow environment. Production quantities of this product are shipped in a standard tape and reel format.

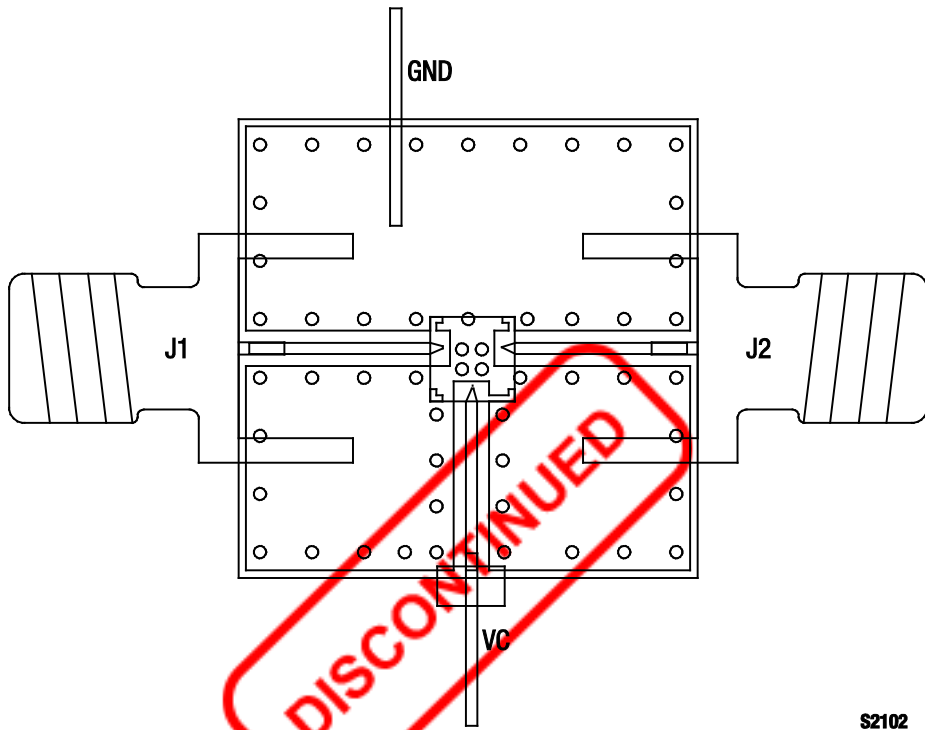

S2102

Figure 9. SKY12146-321LF Evaluation Board Assembly Diagram

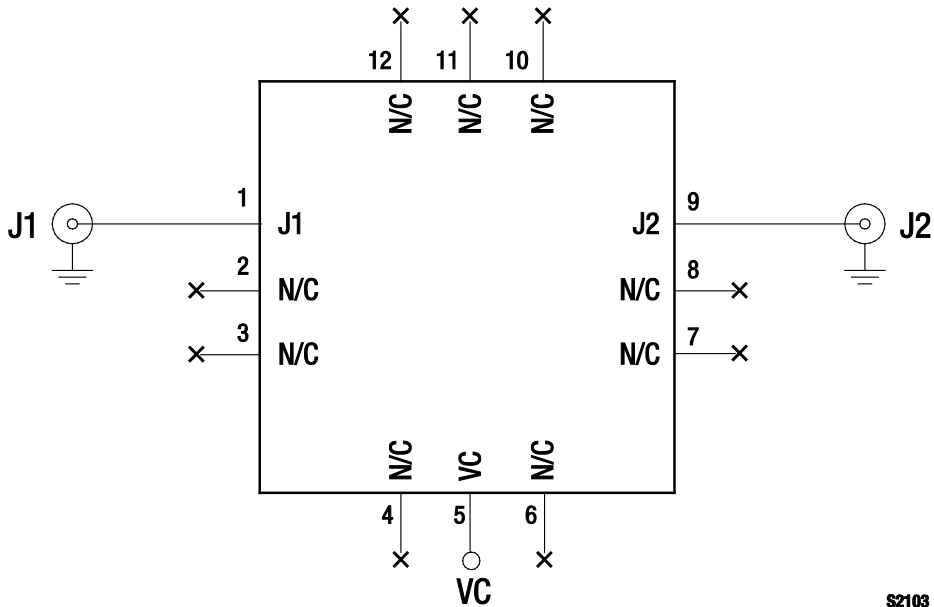

S2103

Figure 10. SKY12146-321LF Evaluation Board Schematic Diagram

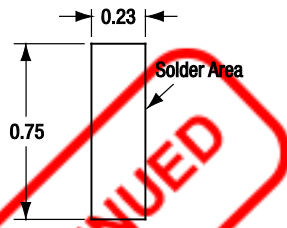
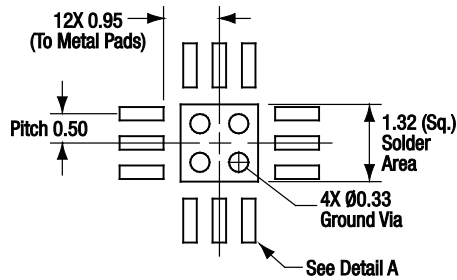

Detail A 12X
Scale = 48X
All measurements in millimeters S1748

Figure 11. SKY12146-321LF PCB Layout Footprint

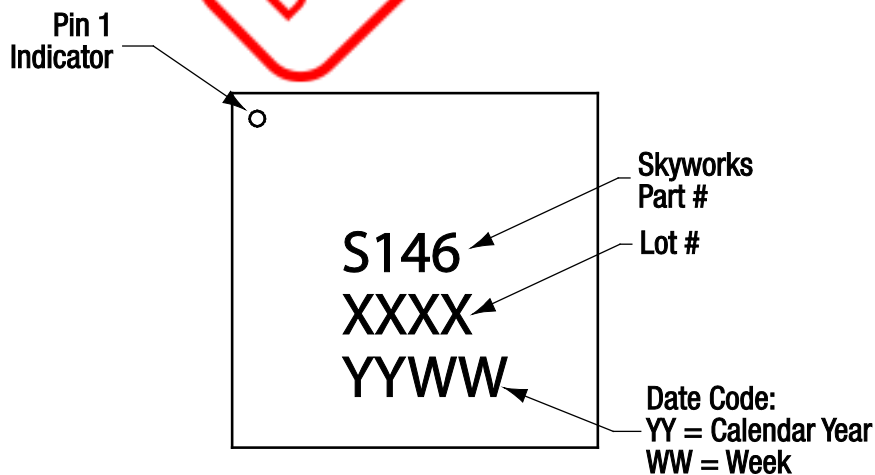
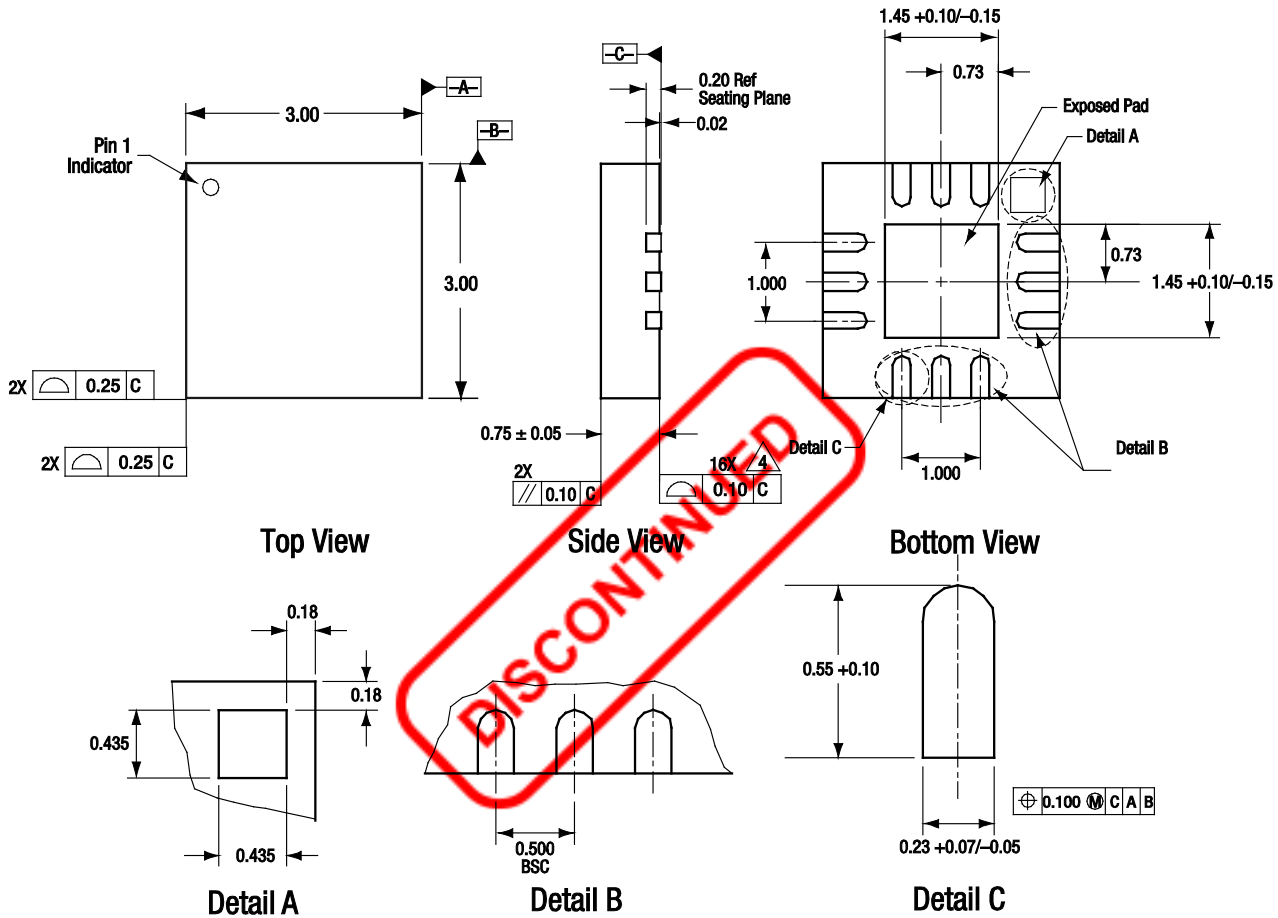

Figure 12. Typical Part Markings (Top View)



All measurements are in millimeters.
 Dimensioning and tolerancing according to ASME Y14.5M-1994.
 Coplanarity applies to the exposed heat sink slug as well as the terminals.
 Plating requirement per source control drawing (SCD) 2504.
 All contact points are Au-plated, Pb-free surfaces.

S1542

Figure 13. SKY12146-321LF 12-Pin QFN Package Dimensions

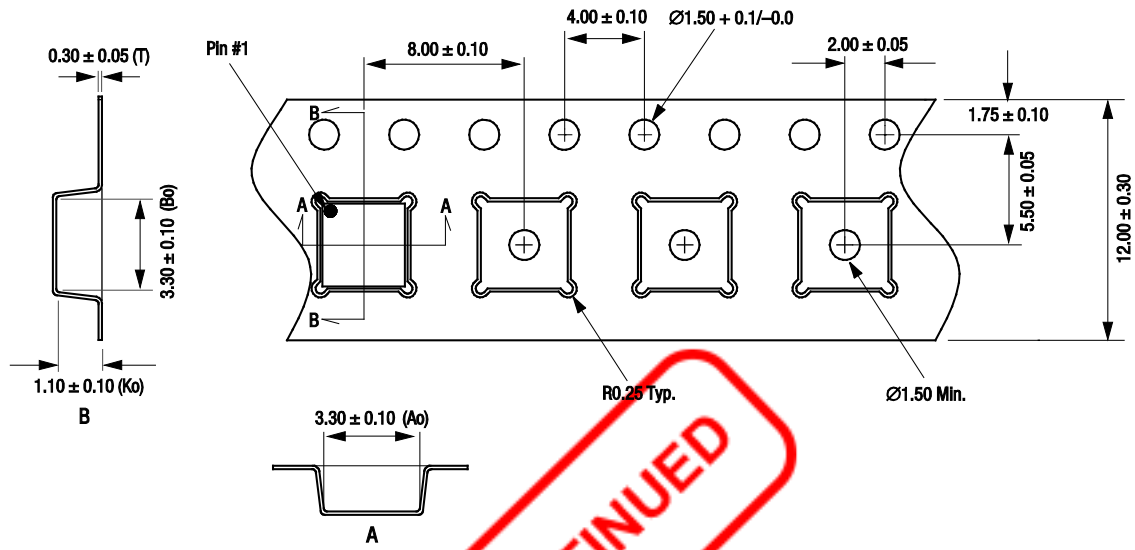

- Notes:
1. Carrier tape: black conductive polystyrene, non-bakeable material.
 2. Cover tape material: transparent conductive HSA.
 3. Cover tape size: 9.20 mm width.
 4. All measurements are in millimeters.

51698

Figure 14. SKY12146-321LF Tape and Reel Dimensions

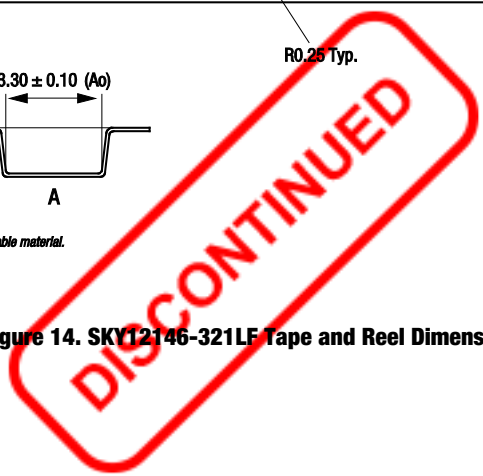

Ordering Information

Model Name	Manufacturing Part Number	Evaluation Board Part Numbers
SKY12146-321LF Differential Digital Attenuator	SKY12146-321LF	SKY12146-321LF-EVB



Copyright © 2002-2008, 2010, 2011 Skyworks Solutions, Inc. All Rights Reserved.

Information in this document is provided in connection with Skyworks Solutions, Inc. (“Skyworks”) products or services. These materials, including the information contained herein, are provided by Skyworks as a service to its customers and may be used for informational purposes only by the customer. Skyworks assumes no responsibility for errors or omissions in these materials or the information contained herein. Skyworks may change its documentation, products, services, specifications or product descriptions at any time, without notice. Skyworks makes no commitment to update the materials or information and shall have no responsibility whatsoever for conflicts, incompatibilities, or other difficulties arising from any future changes.

No license, whether express, implied, by estoppel or otherwise, is granted to any intellectual property rights by this document. Skyworks assumes no liability for any materials, products or information provided hereunder, including the sale, distribution, reproduction or use of Skyworks products, information or materials, except as may be provided in Skyworks Terms and Conditions of Sale.

THE MATERIALS, PRODUCTS AND INFORMATION ARE PROVIDED “AS IS” WITHOUT WARRANTY OF ANY KIND, WHETHER EXPRESS, IMPLIED, STATUTORY, OR OTHERWISE, INCLUDING FITNESS FOR A PARTICULAR PURPOSE OR USE, MERCHANTABILITY, PERFORMANCE, QUALITY OR NON-INFRINGEMENT OF ANY INTELLECTUAL PROPERTY RIGHT; ALL SUCH WARRANTIES ARE HEREBY EXPRESSLY DISCLAIMED. SKYWORKS DOES NOT WARRANT THE ACCURACY OR COMPLETENESS OF THE INFORMATION, TEXT, GRAPHICS OR OTHER ITEMS CONTAINED WITHIN THESE MATERIALS. SKYWORKS SHALL NOT BE LIABLE FOR ANY DAMAGES, INCLUDING BUT NOT LIMITED TO ANY SPECIAL, INDIRECT, INCIDENTAL, STATUTORY, OR CONSEQUENTIAL DAMAGES, INCLUDING WITHOUT LIMITATION, LOST REVENUES OR LOST PROFITS THAT MAY RESULT FROM THE USE OF THE MATERIALS OR INFORMATION, WHETHER OR NOT THE RECIPIENT OF MATERIALS HAS BEEN ADVISED OF THE POSSIBILITY OF SUCH DAMAGE.

Skyworks products are not intended for use in medical, lifesaving or life-sustaining applications, or other equipment in which the failure of the Skyworks products could lead to personal injury, death, physical or environmental damage. Skyworks customers using or selling Skyworks products for use in such applications do so at their own risk and agree to fully indemnify Skyworks for any damages resulting from such improper use or sale.

Customers are responsible for their products and applications using Skyworks products, which may deviate from published specifications as a result of design defects, errors, or operation of products outside of published parameters or design specifications. Customers should include design and operating safeguards to minimize these and other risks. Skyworks assumes no liability for applications assistance, customer product design, or damage to any equipment resulting from the use of Skyworks products outside of stated published specifications or parameters.

Skyworks, the Skyworks symbol, and “Breakthrough Simplicity” are trademarks or registered trademarks of Skyworks Solutions, Inc., in the United States and other countries. Third-party brands and names are for identification purposes only, and are the property of their respective owners. Additional information, including relevant terms and conditions, posted at www.skyworksinc.com, are incorporated by reference.

X-ON Electronics

Largest Supplier of Electrical and Electronic Components

Click to view similar products for [Attenuators](#) category:

Click to view products by [Skyworks](#) manufacturer:

Other Similar products are found below :

[ATN3580-01](#) [HMC305SLP4ETR](#) [MAAD-009195-000100](#) [TGL4201-00](#) [TGL4201-02](#) [TGL4201-03](#) [TGL4201-06](#) [TGL4201-10](#) [ATN3590-15](#) [20-50TPC](#) [D10AA5Z4](#) [18AH-01](#) [18AH-08](#) [ATN3580-20](#) [ATN3590-09](#) [20-50RP](#) [MASW-008322-000000](#) [MAATCC0009TR](#) [PCAF-10](#) [EXB-24AT9AR5X](#) [ATN3580-10](#) [HMC539ALP3ETR](#) [ATN3580-02](#) [WA04P006XCTL](#) [SKY12408-321LF](#) [ATN3580-03](#) [WA04P005XBTL](#) [HMC-VVD104-SX](#) [WA04P007XCTL](#) [SKY12236-11](#) [MAATSS0018TR-3000](#) [HMC656-SX](#) [WA04P001XBTL](#) [MAAV-007941-TR3000](#) [WA04P004XBTL](#) [WA04P002XBTL](#) [HMC941A](#) [PAT0816-C-0DB-T5](#) [PAT0816-C-8DB-T5](#) [PAT1632-C-3DB-T1](#) [PAT1632-C-6DB-T1](#) [PAT1632-C-10DB-T1](#) [PAT1632-C-1DB-T1](#) [PAT0816-C-2DB-T5](#) [PAT0816-C-4DB-T5](#) [DHM510-0100-006](#) [MAT10300](#) [MAT10180](#) [MAATCC0007-TB](#) [MAATCC0011](#)