

DATA SHEET

# SKY65095-360LF: 1600 to 2100 MHz Low-Noise Power Amplifier Driver

## Applications

- 2.5G, 3G, 4G wireless infrastructure transceivers
- ISM band transmitters
- WCS fixed wireless
- 3GPP LTE

## Features

- Wideband frequency range: 1600 to 2100 MHz
- Low noise figure: 4.5 dB
- High IIP3 up to +32 dBm
- Output P1dB = +28.5 dBm
- High gain: +14.5 dBm
- Single DC supply: +5 V
- Enable voltage: +3.3 V
- On-chip bias circuit
- DFN (8-pin, 2 x 2 mm) package (MSL1, 260 °C per JEDEC J-STD-020)

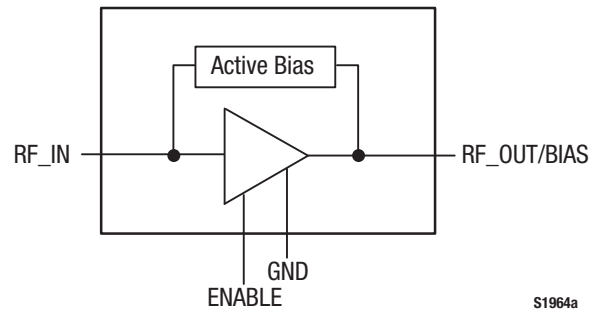


Figure 1. SKY65095-360LF Functional Block Diagram

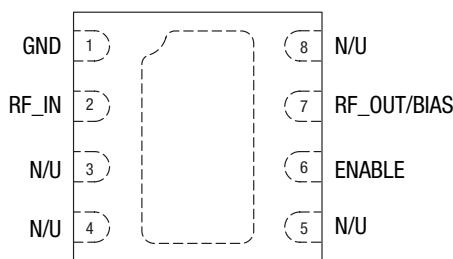
## Description

The Skyworks SKY65095-360LF is a high-performance, ultra-wideband power amplifier (PA) driver with superior output power, low noise, and linearity. The device provides excellent noise figure (NF) and high output power at 1 dB compression, which makes the SKY65095-360LF ideal for use in the driver stage of infrastructure transmit or receive chains.

The SKY65095-360LF uses low-cost surface-mount technology (SMT) in the form of an 8-pin, 2 x 2 mm Dual Flat No-Lead (DFN) package. A functional block diagram is provided in Figure 1, and the device package and pinout are shown in Figure 2. Signal pin assignments and functional pin descriptions are described in Table 1.



Skyworks Green™ products are compliant with all applicable legislation and are halogen-free. For additional information, refer to *Skyworks Definition of Green™*, document number SQ04-0074.



S2494

Figure 2. SKY65095-360LF Pinout (Top View)

**Table 1. SKY65095-360LF Signal Descriptions**

Pin	Name	Description	Pin	Name	Description
1	GND	Ground	5	N/U	Not used (may be grounded)
2	RF_IN	RF input	6	ENABLE	PA enable
3	N/U	Not used (may be grounded)	7	RF_OUT/BIAS	RF output/bias voltage
4	N/U	Not used (may be grounded)	8	N/U	Not used (may be grounded)

### Technical Description

The SKY65095-360LF is a single-stage, low-noise PA that operates with a single 5 V power supply connected through an RF choke (inductor L1) to the output signal (pin 7). The bias current is set by the on-chip active bias composed of current mirror and reference voltage transistors, which allow excellent gain tracking over temperature and voltage variations. The device is externally RF matched using surface-mount components to facilitate operation over a frequency range of 1600 to 2100 MHz.

### Electrical and Mechanical Specifications

The absolute maximum ratings of the SKY65095-360LF are provided in Table 2. The recommended operating conditions are specified in Table 3 and electrical specifications are provided in Table 4 (general specifications), Table 5 (1626 to 1660 MHz), Table 6 (1710 to 1780 MHz), Table 7 (1850 to 1910 MHz), Table 8 (1920 to 1980 MHz), and Table 9 (2010 to 2025 MHz).

Typical performance characteristics of the SKY65095-360LF are illustrated in Figures 3 through 13 (1626 to 1660 MHz), Figures 14 through 24 (1710 to 1785 MHz), Figures 25 through 44 (1850 to 1910 MHz), Figures 45 through 55 (1920 to 1980 MHz), and Figures 56 through 66 (2010 to 2025 MHz).

**Table 2. SKY65095-360LF Absolute Maximum Ratings<sup>1</sup>**

Parameter	Symbol	Minimum	Maximum	Units
Supply voltage	V <sub>CC</sub>	-0.3	+6.0	V
RF input power	P <sub>IN</sub>		+20	dBm
Supply current @ P1dB	I <sub>CC</sub>		400	mA
Power dissipation @ P1dB	P <sub>D</sub>		1.1	W
Power dissipation @ P <sub>IN</sub> = -10 dBm	P <sub>D</sub>		0.7	W
Operating case temperature	T <sub>C</sub>	0	+70	°C
Extended operating temperature	T <sub>EXT</sub>	-33	+95	°C
Storage temperature	T <sub>ST</sub>	-55	+150	°C
Junction temperature @ P <sub>IN</sub> = -10 dBm	T <sub>J</sub>		+150	°C
Thermal resistance @ P <sub>IN</sub> = -10 dBm	Θ <sub>JC</sub>		35	°C/W

<sup>1</sup> Exposure to maximum rating conditions for extended periods may reduce device reliability. There is no damage to device with only one parameter set at the limit and all other parameters set at or below their nominal values. Exceeding any of the limits listed here may result in permanent damage to the device.

**ESD HANDLING:** *Although this device is designed to be as robust as possible, electrostatic discharge (ESD) can damage this device. This device must be protected at all times from ESD when handling or transporting. Static charges may easily produce potentials of several kilovolts on the human body or equipment, which can discharge without detection. Industry-standard ESD handling precautions should be used at all times.*

**Table 3. SKY65095-360LF Recommended Operating Conditions**

Parameter	Symbol	Min	Typ	Max	Units
Bias voltage	V <sub>CC</sub>	4.75	5.00	5.25	V
Enable voltage	V <sub>EN</sub>		3.3		V
Operating frequency	f	1600		2100	MHz

**Table 4. SKY65095-360LF Electrical Characteristics: General Specifications<sup>1</sup>**  
(V<sub>CC</sub> = +5 V, T<sub>J</sub> = 25 °C, CW, Unless Otherwise Noted)

Parameter	Symbol	Test Conditions	Min	Typical	Max	Units
Quiescent current	I <sub>Q</sub>	No RF		135	145	mA
Gain vs temperature			-0.02		+0.02	dB/°C
0.1 dB output compression point	OP0.1dB	Sweep input power	+22			dBm
Turn-on time		P <sub>IN</sub> = -10 dBm, V <sub>EN</sub> = 3.3 V		1		μs
Stability		P <sub>IN</sub> = 0 dBm, T <sub>J</sub> = 0 °C	Unconditional			-

<sup>1</sup> Performance is guaranteed only under the conditions listed in this table, and corresponds to the Bill of Materials in Table 10 for each frequency band.

**Table 5. SKY65095-360LF Electrical Characteristics: 1626 to 1660 MHz<sup>1</sup>**  
(V<sub>CC</sub> = +5 V, T<sub>J</sub> = 25 °C, f = 1643 MHz, CW, Unless Otherwise Noted)

Parameter	Symbol	Test Conditions	Min	Typ	Max	Units
Frequency	f		1626		1660	MHz
Third order input intercept point	IIP3	P <sub>IN</sub> = -10 dBm/tone, 5 MHz spacing		+29.5		dBm
Small signal gain	IS21I	P <sub>IN</sub> = -30 dBm		15.0		dB
Input return loss	IS11I	P <sub>IN</sub> = -30 dBm		25		dB
Output return loss	IS22I	P <sub>IN</sub> = -30 dBm		7.5		dB
Noise figure	NF			4.5		dB
1 dB output compression point	OP1dB	Sweep input power		+27.5		dBm

<sup>1</sup> Performance is verified by characterization. Evaluation Board input trace loss up to DC blocking capacitors = 0.16 dB. Output trace loss up to DC blocking capacitors = 0.16 dB.

**Table 6. SKY65095-360LF Electrical Characteristics: 1710 to 1785 MHz<sup>1</sup>**  
(V<sub>CC</sub> = +5 V, T<sub>J</sub> = 25 °C, f = 1747.5 MHz, CW, Unless Otherwise Noted)

Parameter	Symbol	Test Conditions	Min	Typ	Max	Units
Frequency	f		1710		1785	MHz
Third order input intercept point	IIP3	P <sub>IN</sub> = -10 dBm/tone, 5 MHz spacing		+29.5		dBm
Small signal gain	IS21I	P <sub>IN</sub> = -30 dBm		14.5		dB
Input return loss	IS11I	P <sub>IN</sub> = -30 dBm		25.5		dB
Output return loss	IS22I	P <sub>IN</sub> = -30 dBm		8.2		dB
Noise figure	NF			4.5		dB
1 dB output compression point	OP1dB	Sweep input power		+27.2		dBm

<sup>1</sup> Performance is verified by characterization. Evaluation Board input trace loss up to DC blocking capacitors = 0.17 dB. Output trace loss up to DC blocking capacitors = 0.17 dB.

**Table 7. SKY65095-360LF Electrical Characteristics: 1850 to 1910 MHz, Production Screen Tested<sup>1</sup>**  
**(VCC = +5 V, T<sub>J</sub> = 25 °C, f = 1880 MHz, CW, Unless Otherwise Noted)**

Parameter	Symbol	Test Conditions	Min	Typ	Max	Units
Frequency	f		1850		1910	MHz
Third order input intercept point	IIP3	P <sub>IN</sub> = -10 dBm/tone, 5 MHz spacing	+28.0	+31.5		dBm
Small signal gain	IS21I	P <sub>IN</sub> = -30 dBm	14	15	16	dB
Gain vs frequency			-0.25		+0.25	dB/20 MHz
Input return loss	IS11I	P <sub>IN</sub> = -30 dBm	17	23		dB
Output return loss	IS22I	P <sub>IN</sub> = -30 dBm	7	10		dB
Noise figure	NF			4.4	5.1	dB
1 dB output compression point	OP1dB	Sweep input power	+26	+27		dBm

<sup>1</sup> Performance is guaranteed only under the conditions listed in this table, and corresponds to the Bill of Materials in Table 10 for each frequency band. Evaluation Board input trace loss up to DC blocking capacitors = 0.17 dB. Output trace loss up to DC blocking capacitors = 0.18 dB.

**Table 8. SKY65095-360LF Electrical Characteristics: 1920 to 1980 MHz<sup>1</sup>**  
**(VCC = +5 V, T<sub>J</sub> = 25 °C, f = 1960 MHz, CW, Unless Otherwise Noted)**

Parameter	Symbol	Test Conditions	Min	Typ	Max	Units
Frequency	f		1920		1980	MHz
Third order input intercept point	IIP3	P <sub>IN</sub> = -10 dBm/tone, 5 MHz spacing		+34.5		dBm
Small signal gain	IS21I	P <sub>IN</sub> = -30 dBm		14.7		dB
Input return loss	IS11I	P <sub>IN</sub> = -30 dBm		26.2		dB
Output return loss	IS22I	P <sub>IN</sub> = -30 dBm		11.3		dB
Noise figure	NF			4.5		dB
1 dB output compression point	OP1dB	Sweep input power		+28.3		dBm

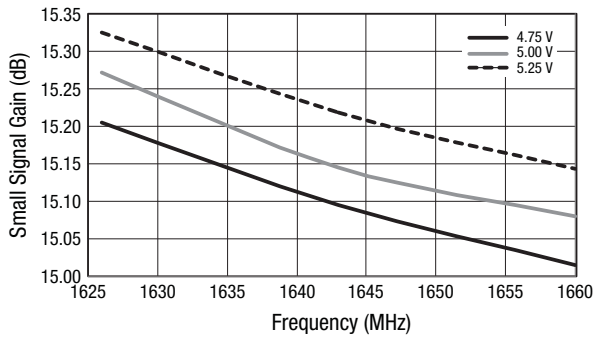
<sup>1</sup> Performance is verified by characterization. Evaluation Board input trace loss up to DC blocking capacitors = 0.16 dB. Output trace loss up to DC blocking capacitors = 0.16 dB.

**Table 9. SKY65095-360LF Electrical Characteristics: 2010 to 2025 MHz<sup>1</sup>**  
**(VCC = +5 V, T<sub>J</sub> = 25 °C, f = 2017.5 MHz, CW, Unless Otherwise Noted)**

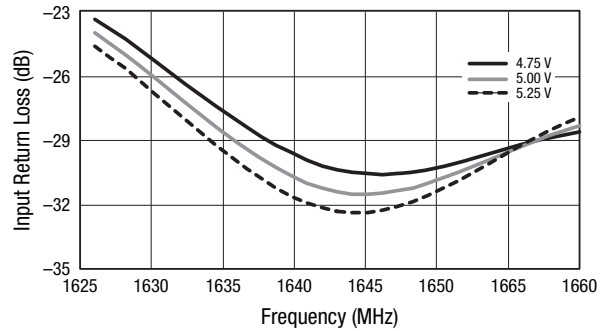
Parameter	Symbol	Test Conditions	Min	Typ	Max	Units
Frequency	f		2010		2025	MHz
Third order input intercept point	IIP3	P <sub>IN</sub> = -10 dBm/tone, 5 MHz spacing		+33.7		dBm
Small signal gain	IS21I	P <sub>IN</sub> = -30 dBm		14.4		dB
Input return loss	IS11I	P <sub>IN</sub> = -30 dBm		20.4		dB
Output return loss	IS22I	P <sub>IN</sub> = -30 dBm		9.5		dB
Noise figure	NF			4.2		dB
1 dB output compression point	OP1dB	Sweep input power		+26.5		dBm

<sup>1</sup> Performance is verified by characterization. Evaluation Board input trace loss up to DC blocking capacitors = 0.19 dB. Output trace loss up to DC blocking capacitors = 0.19 dB.

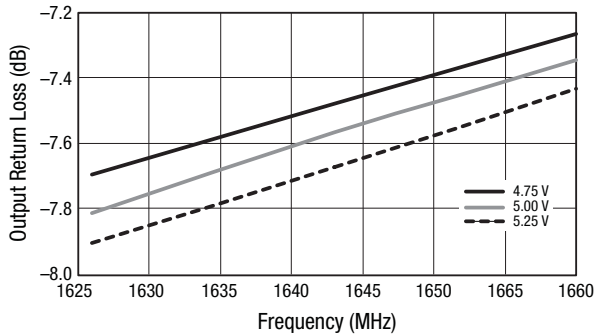
**Typical Performance Characteristics (1626 to 1660 MHz)  
(Based on BOM in Table 10)**



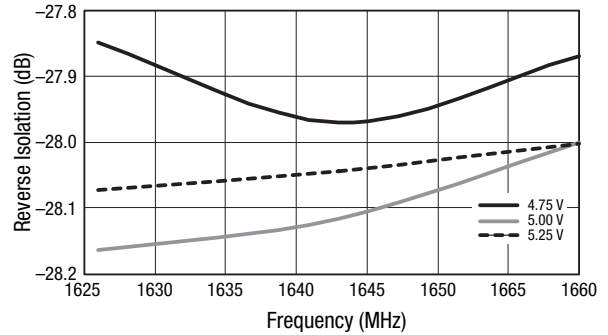
**Figure 3. Small Signal Gain vs Frequency Over Voltage**



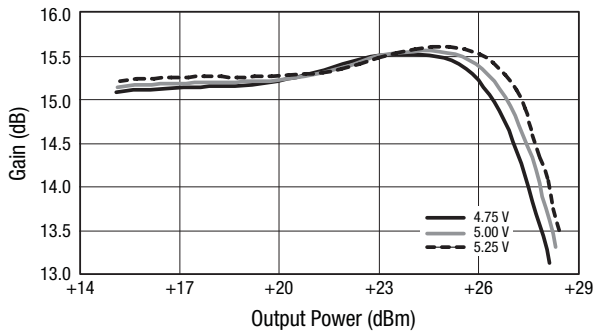
**Figure 4. Input Return Loss vs Frequency Over Voltage**



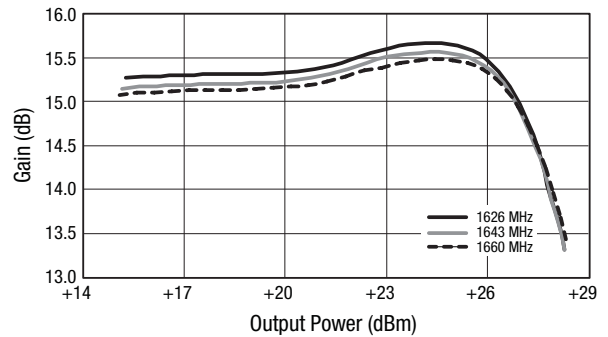
**Figure 5. Output Return Loss vs Frequency Over Voltage**



**Figure 6. Reverse Isolation vs Frequency Over Voltage**



**Figure 7. Gain vs Output Power Over Voltage**



**Figure 8. Gain vs Output Power Over Frequency**

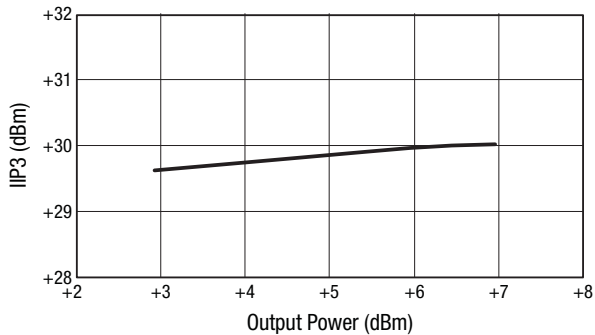


Figure 9. IIP3 vs Output Power

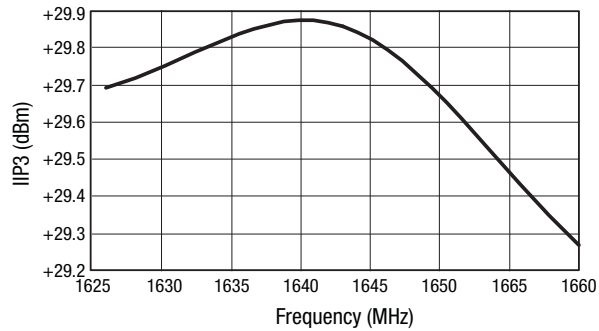


Figure 10. IIP3 vs Frequency (PIN = -10 dBm)

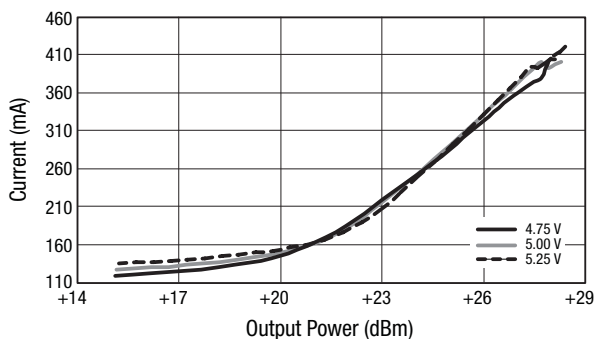


Figure 11. Operational Current vs Output Power Over Voltage

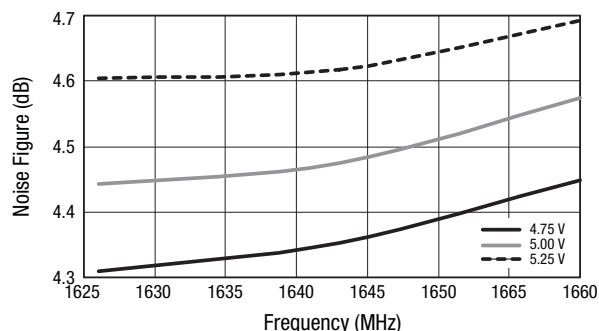


Figure 12. Noise Figure vs Frequency Over Voltage

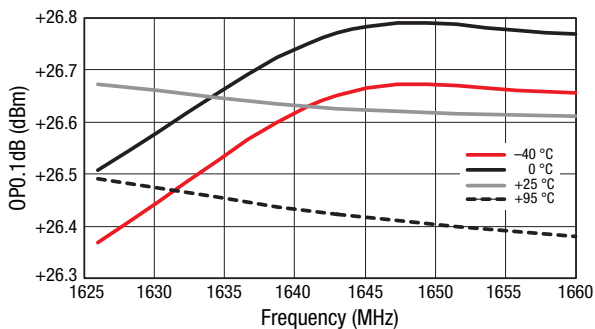
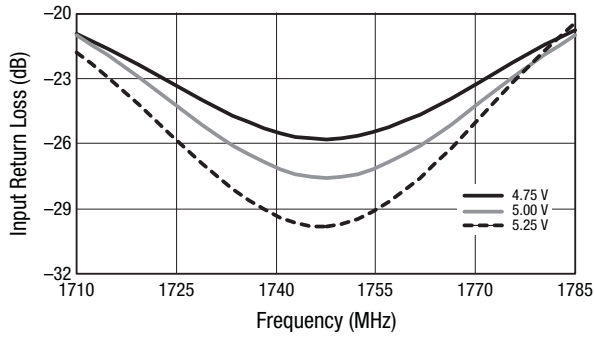
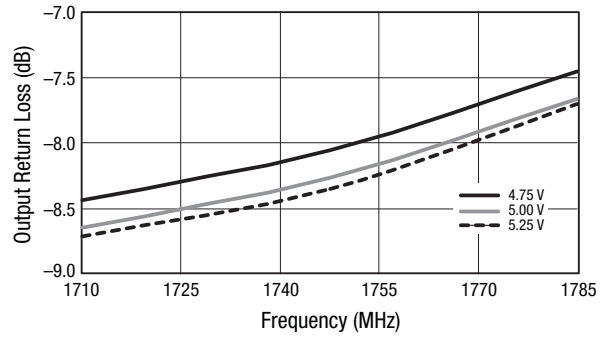


Figure 13. OP0.1dB vs Frequency Over Temperature

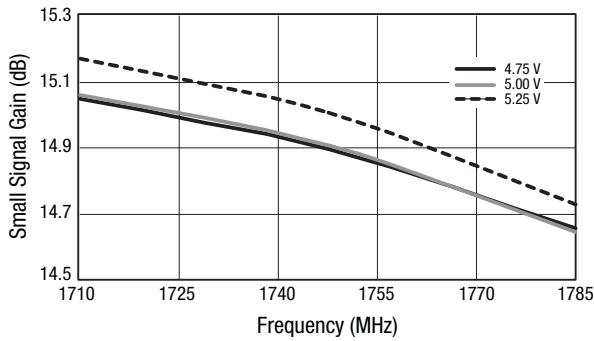
**Typical Performance Characteristics (1710 to 1785 MHz)  
(Based on BOM in Table 10)**



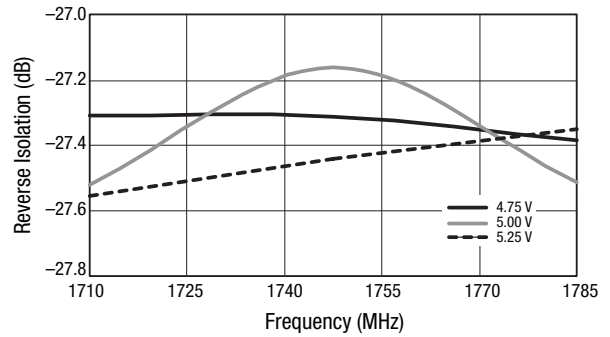
**Figure 14. Input Return Loss vs Frequency Over Voltage**



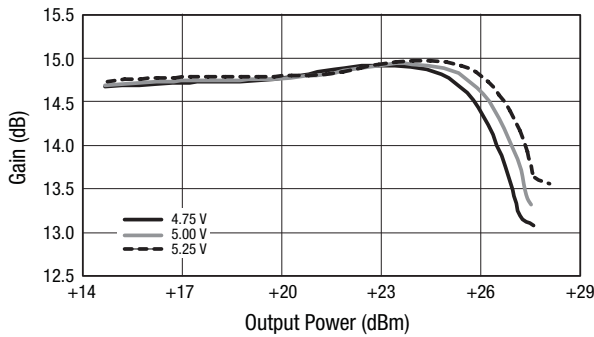
**Figure 15. Output Return Loss vs Frequency Over Voltage**



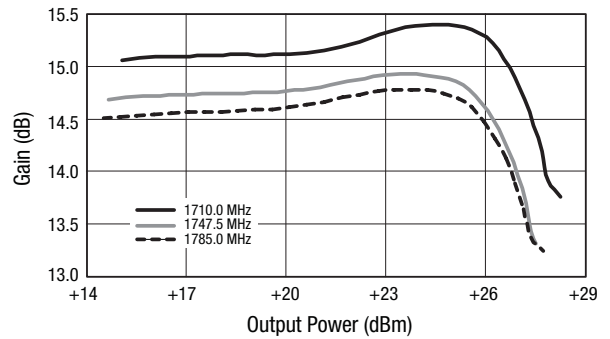
**Figure 16. Small Signal Gain vs Frequency Over Voltage**



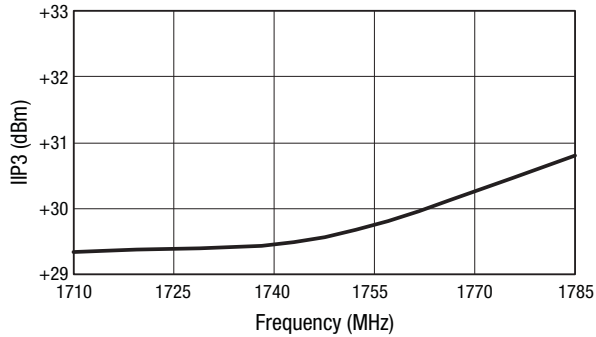
**Figure 17. Reverse Isolation vs Frequency Over Voltage**



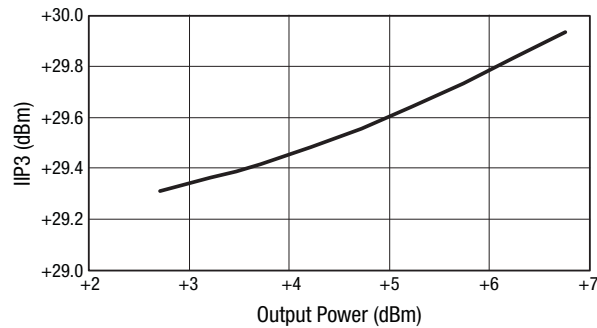
**Figure 18. Gain vs Output Power Over Voltage**



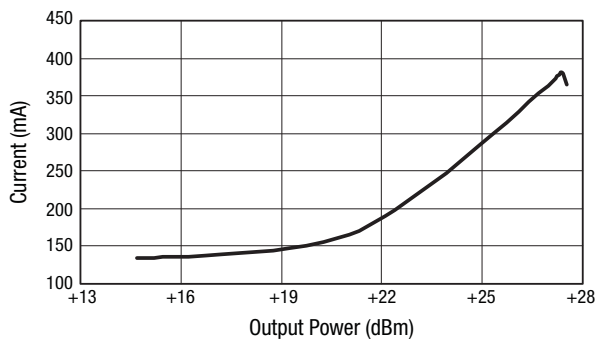
**Figure 19. Gain vs Output Power Over Frequency**



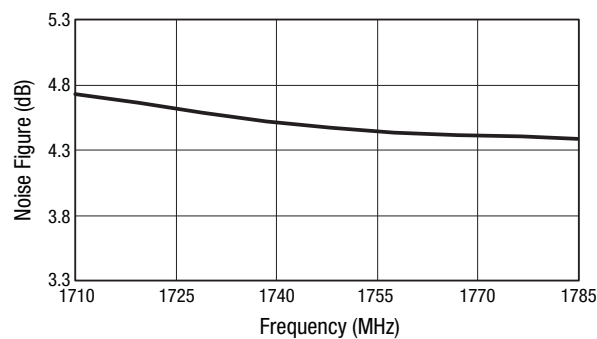
**Figure 20. IIP3 vs Frequency (PIN = -10 dBm)**



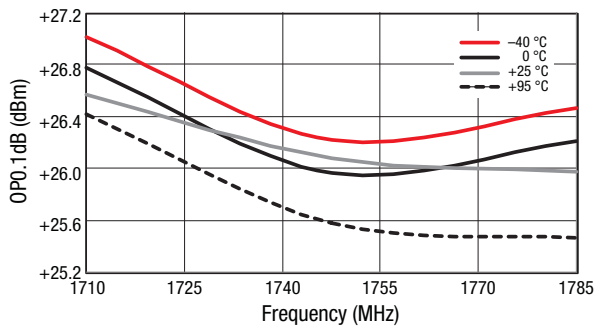
**Figure 21. IIP3 vs Output Power**



**Figure 22. Operational Current vs Output Power**



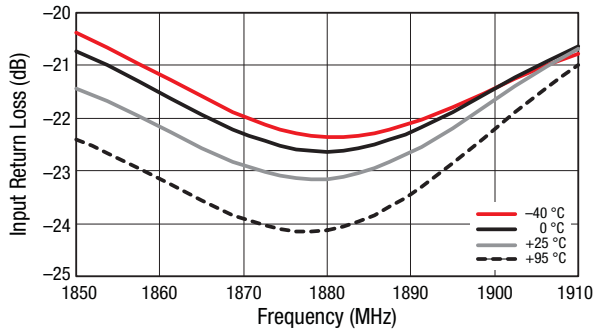
**Figure 23. Noise Figure vs Frequency**



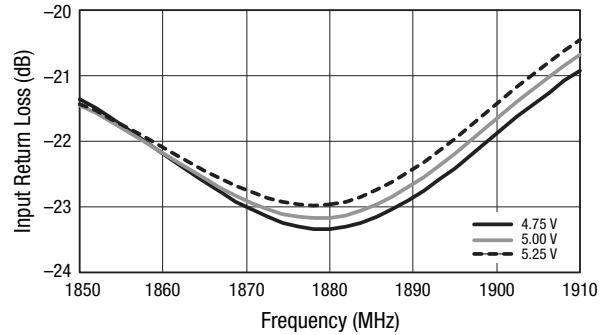
**Figure 24. OP0.1dB vs Frequency Over Temperature**



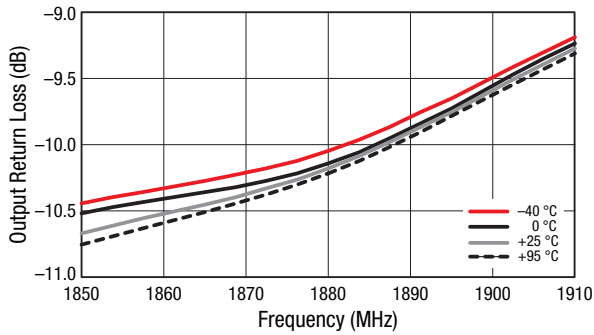
**Typical Performance Characteristics (1850 to 1910 MHz)  
(Based on BOM in Table 10)**



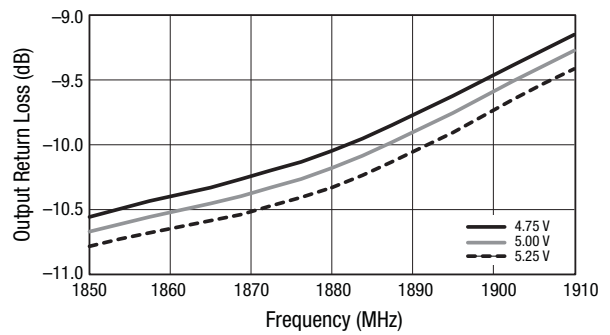
**Figure 25. Input Return Loss vs Frequency Over Temperature**



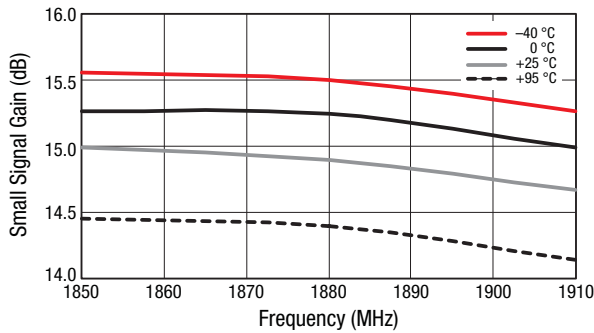
**Figure 26. Input Return Loss vs Frequency Over Voltage**



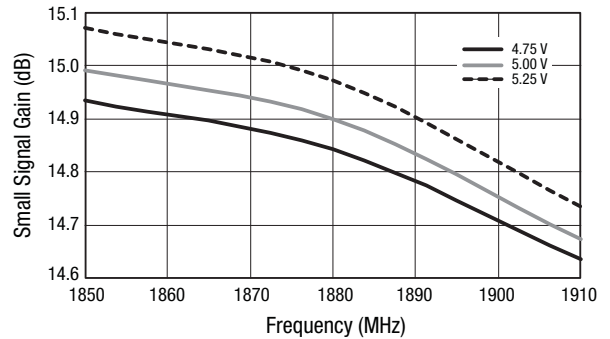
**Figure 27. Output Return Loss vs Frequency Over Temperature**



**Figure 28. Output Return Loss vs Frequency Over Voltage**



**Figure 29. Small Signal Gain vs Frequency Over Temperature**



**Figure 30. Small Signal Gain vs Frequency Over Voltage**

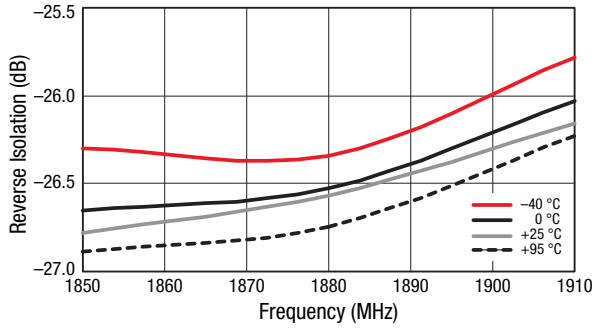


Figure 31. Reverse Isolation vs Frequency Over Temperature

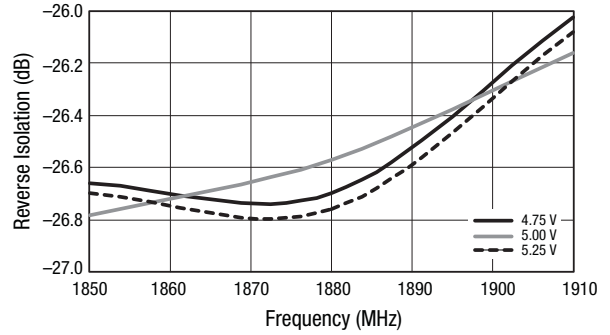


Figure 32. Reverse Isolation vs Frequency Over Voltage

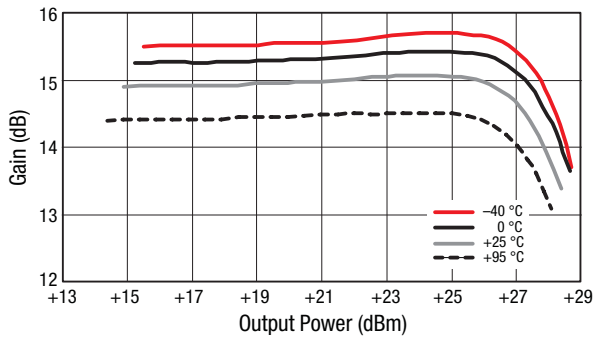


Figure 33. Gain vs Output Power Over Temperature

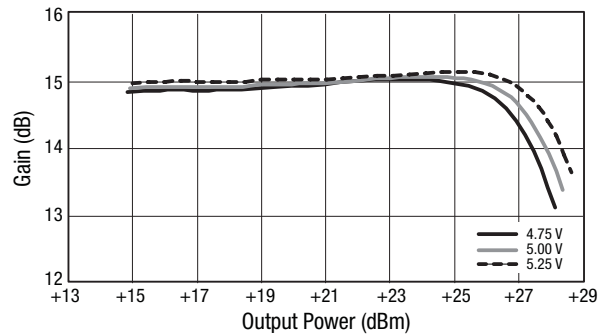


Figure 34. Gain vs Output Power Over Voltage

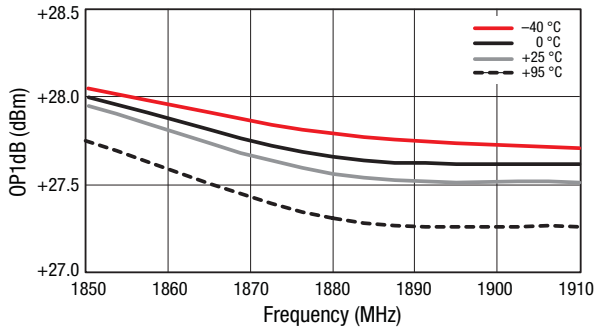


Figure 35. OP1dB vs Frequency Over Temperature

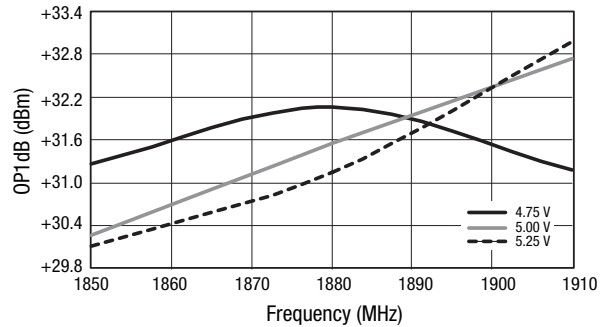


Figure 36. OP1dB vs Frequency Over Voltage

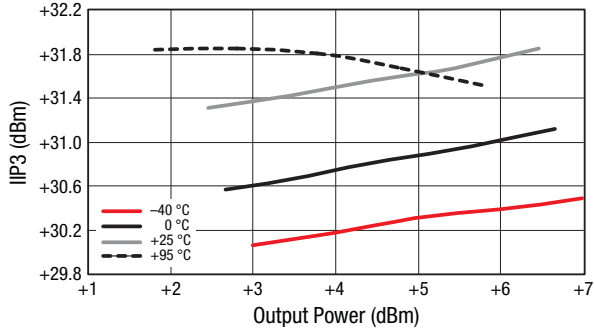


Figure 37. IIP3 vs Output Power Over Temperature

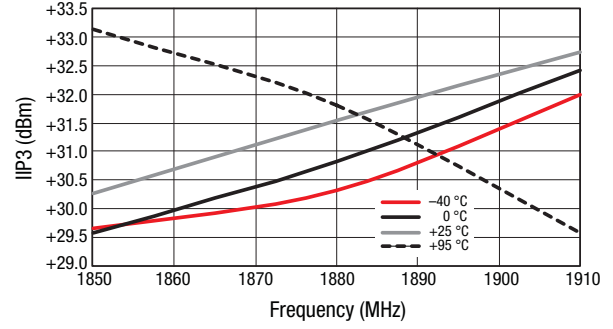


Figure 38. IIP3 vs Frequency Over Temperature

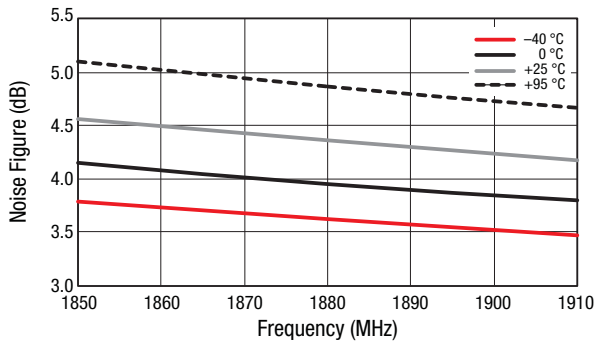


Figure 39. Noise Figure vs Frequency Over Temperature

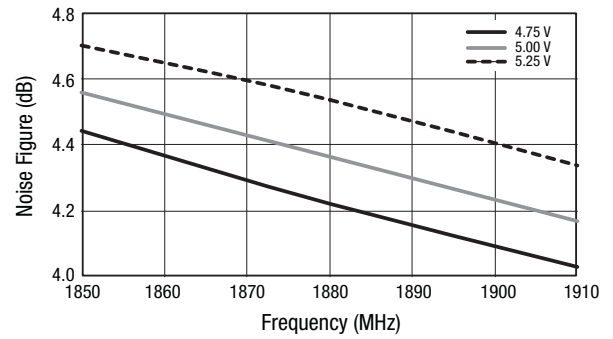


Figure 40. Noise Figure vs Frequency Over Voltage

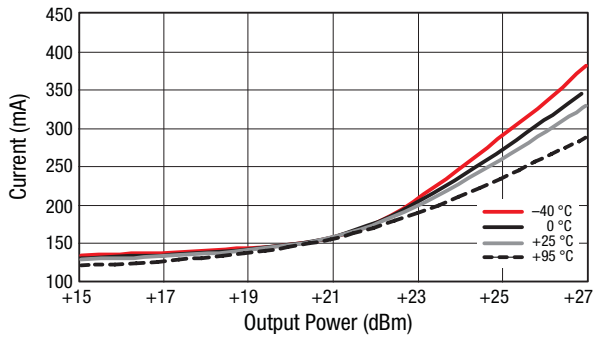


Figure 41. Operational Current vs Output Power Over Temperature

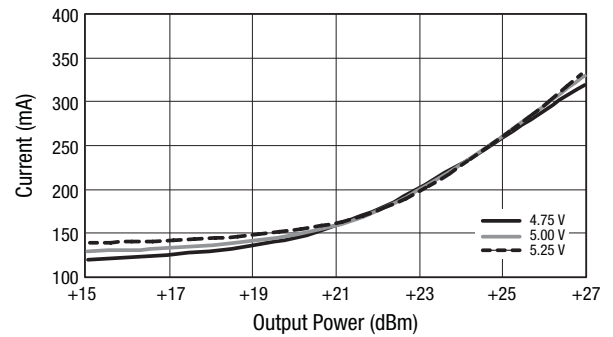


Figure 42. Operational Current vs Output Power Over Voltage

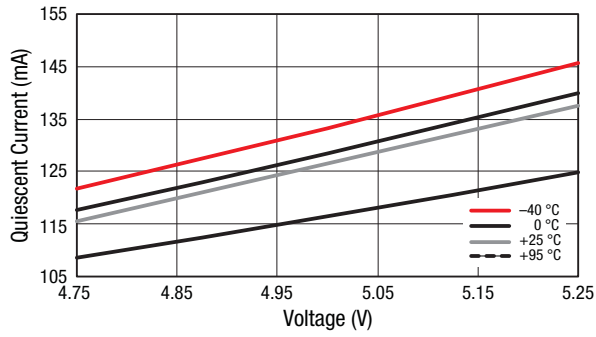


Figure 43. Quiescent Current vs Voltage Over Temperature

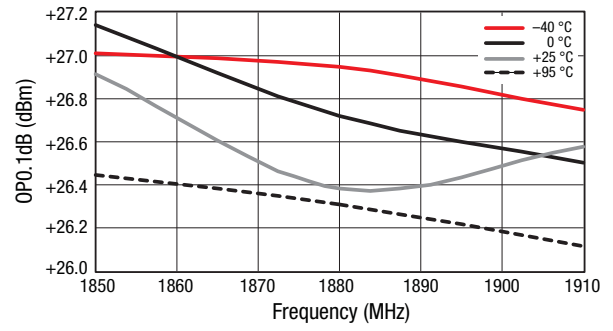
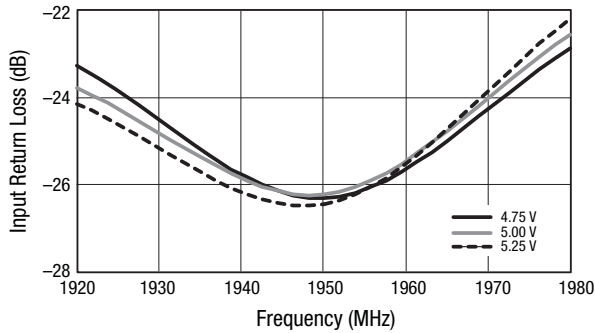
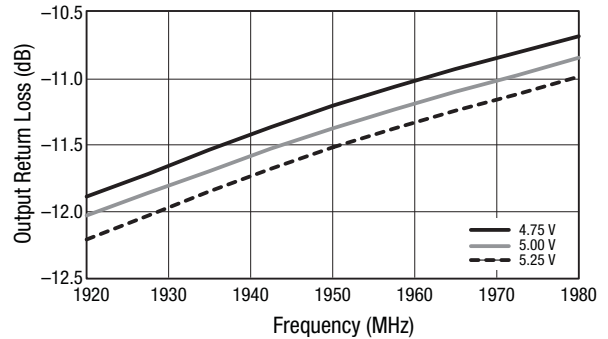


Figure 44. OP0.1dB vs Frequency Over Temperature

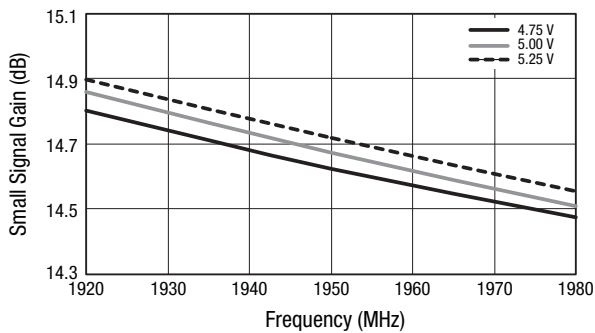
**Typical Performance Characteristics (1920 to 1980 MHz)  
(Based on BOM in Table 10)**



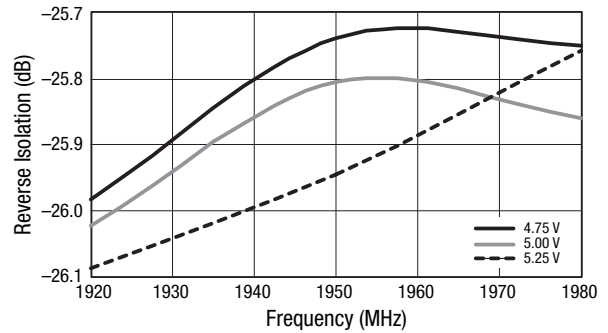
**Figure 45. Input Return Loss vs Frequency Over Voltage**



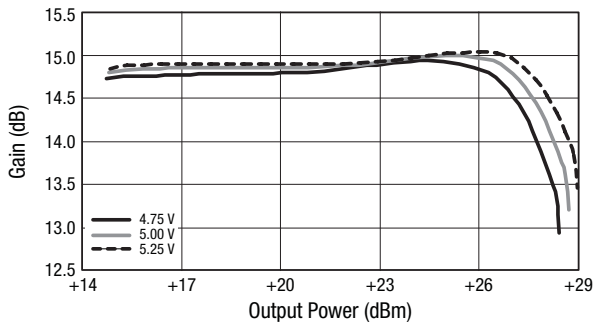
**Figure 46. Output Return Loss vs Frequency Over Voltage**



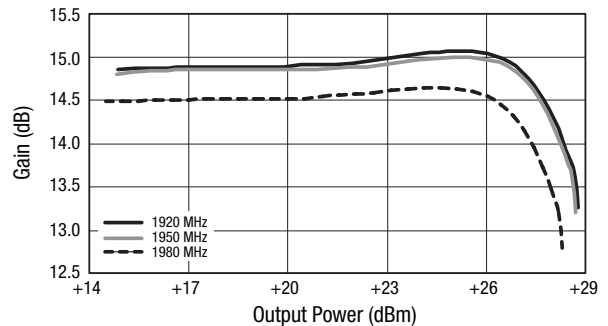
**Figure 47. Small Signal Gain vs Frequency Over Voltage**



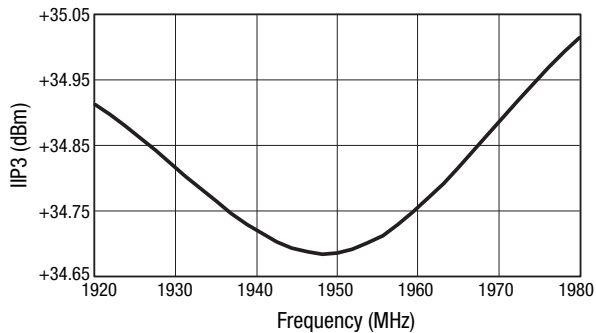
**Figure 48. Reverse Isolation vs Frequency Over Voltage**



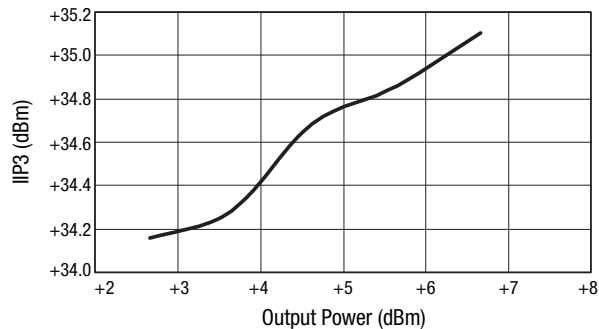
**Figure 49. Gain vs Output Power Over Voltage**



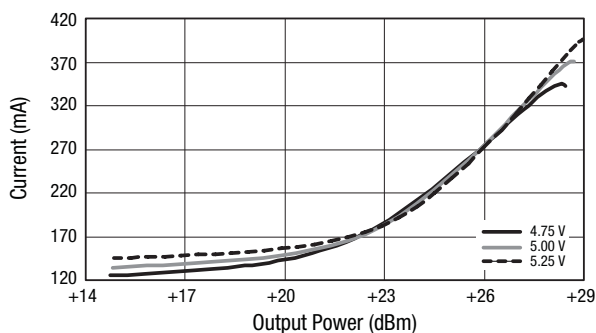
**Figure 50. Gain vs Output Power Over Frequency**



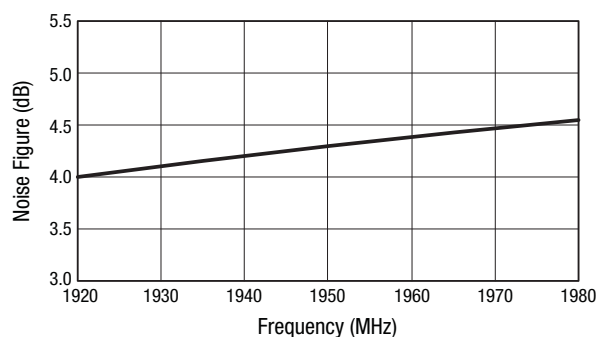
**Figure 51. IIP3 vs Frequency (PIN = -10 dBm)**



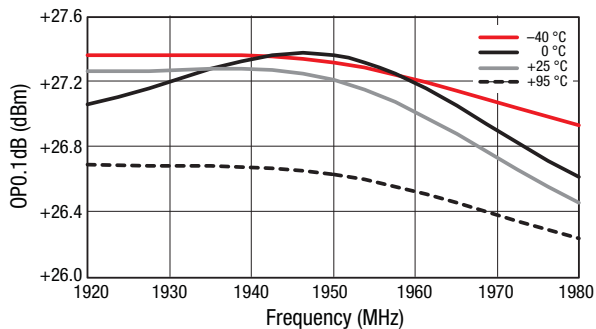
**Figure 52. IIP3 vs Output Power**



**Figure 53. Operational Current vs Output Power Over Voltage**

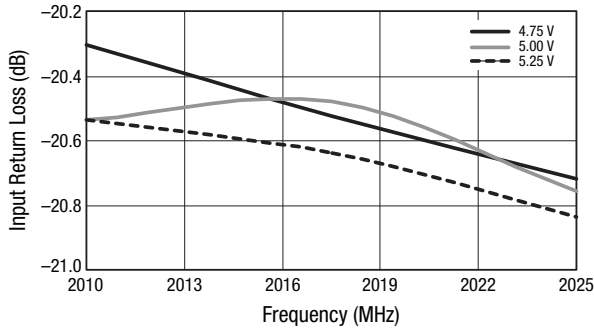


**Figure 54. Noise Figure vs Frequency**

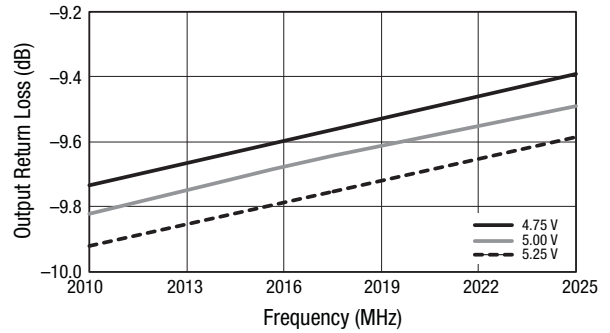


**Figure 55. OP0.1dB vs Frequency Over Temperature**

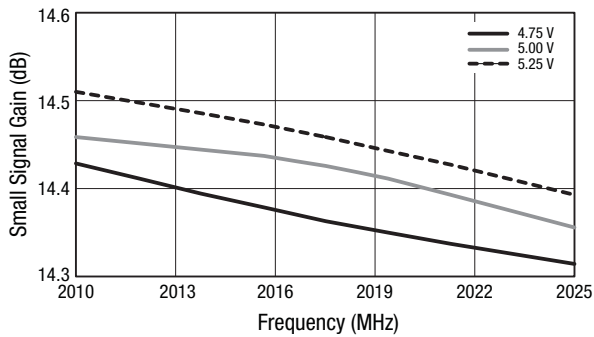
**Typical Performance Characteristics (2010 to 2025 MHz)  
(Based on BOM in Table 10)**



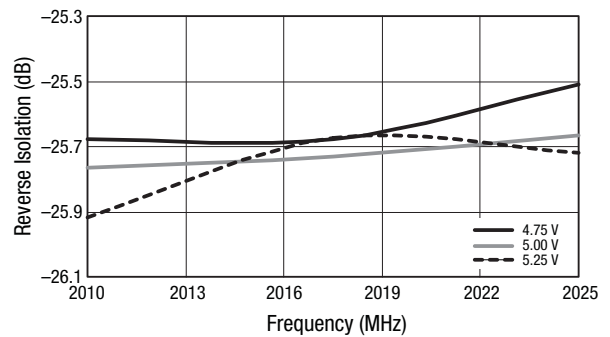
**Figure 56. Input Return Loss vs Frequency Over Voltage**



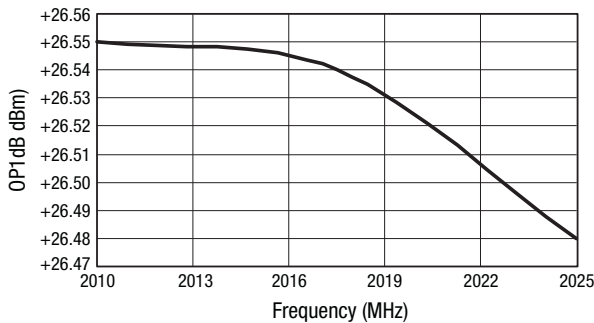
**Figure 57. Output Return Loss vs Frequency Over Voltage**



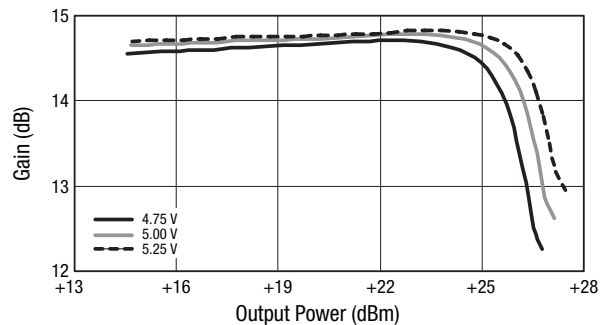
**Figure 58. Small Signal Gain vs Frequency Over Voltage**



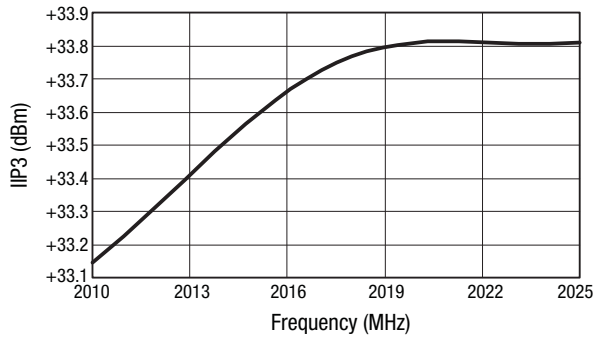
**Figure 59. Reverse Isolation vs Frequency Over Voltage**



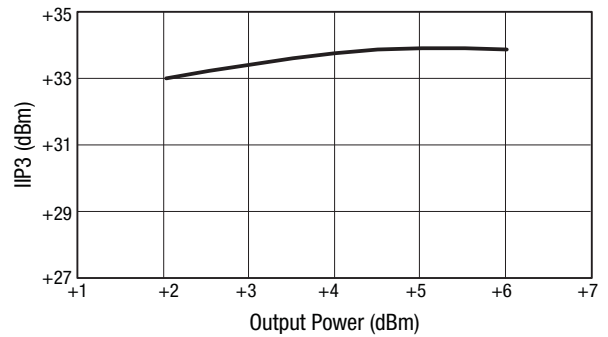
**Figure 60. OP1dB vs Frequency**



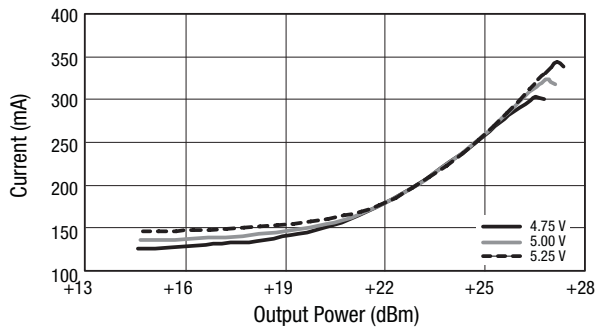
**Figure 61. Gain vs Output Power Over Voltage**



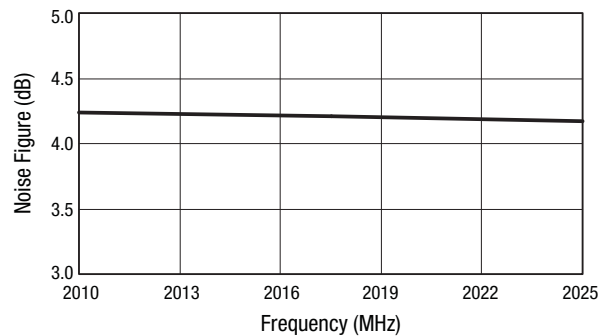
**Figure 62. IIP3 vs Frequency**  
( $P_{IN} = -10$  dBm)



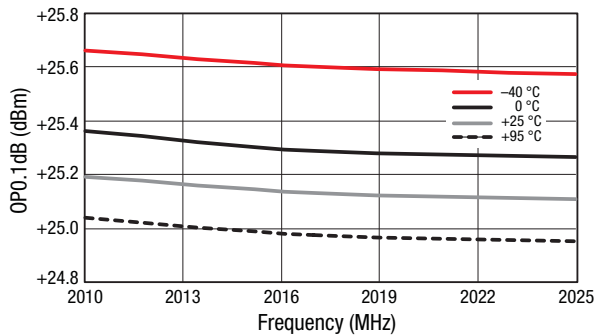
**Figure 63. IIP3 vs Output Power**



**Figure 64. Operational Current vs Output Power Over Voltage**



**Figure 65. Noise Figure vs Frequency**



**Figure 66. OP0.1dB vs Frequency Over Temperature**



### Evaluation Board Description

The Skyworks SKY65095-360LF Evaluation Board is used to test the performance of the SKY65095-360LF PA driver. An assembly drawing for the Evaluation Board is shown in Figure 67 and the layer detail is provided in Figure 68. The layer detail physical characteristics are noted in Figure 69.

Capacitor C10 provides DC bias decoupling for the output stage collector voltage. Pins 2 and 7 are the RF input and output signals, respectively. External DC blocking is required on the input and output, but can be implemented as part of the RF matching circuit. Ground pin 1 and the center ground pad provide the DC and RF ground.

A suggested matching circuit is shown in Figure 70 with component values for the SKY65095-360LF Evaluation Board listed in Table 10.

### Testing Procedure

Use the following procedure to set up the SKY65095-360LF Evaluation Board for testing:

1. Connect a 5.0 V supply to the VCC pin and 3.3 V to the ENABLE pin of the J3 header (see Evaluation Board assembly drawing in Figure 67 and schematic diagram in Figure 70). If available, enable the current limiting function of the power supply to 500 mA.
2. Connect a signal generator to the RF signal input port. Set it to the desired RF frequency at a power level of -15 dBm or less to the Evaluation Board but do NOT enable the RF signal.
3. Connect a spectrum analyzer to the RF signal output port.
4. Enable the power supply.
5. Enable the RF signal.
6. Take measurements.

### Circuit Design Configurations

The following design considerations are general in nature and must be followed regardless of final use or configuration.

- Paths to ground should be made as short as possible.
- The ground pad of the SKY65095-360LF power amplifier has special electrical and thermal grounding requirements. This pad is the main thermal conduit for heat dissipation. Since the circuit board acts as the heat sink, it must shunt as much heat as possible from the amplifier.

Therefore, design the connection to the ground pad to dissipate the maximum wattage produced to the circuit board. Multiple vias to the grounding layer are required.

**NOTE:** Junction temperature ( $T_j$ ) of the device increases with a poor connection to the slug and ground. This reduces the lifetime of the device.

---

**CAUTION:** If any of the output signals exceed the rated maximum values, the SKY65095-360LF Evaluation Board can be permanently damaged.

---

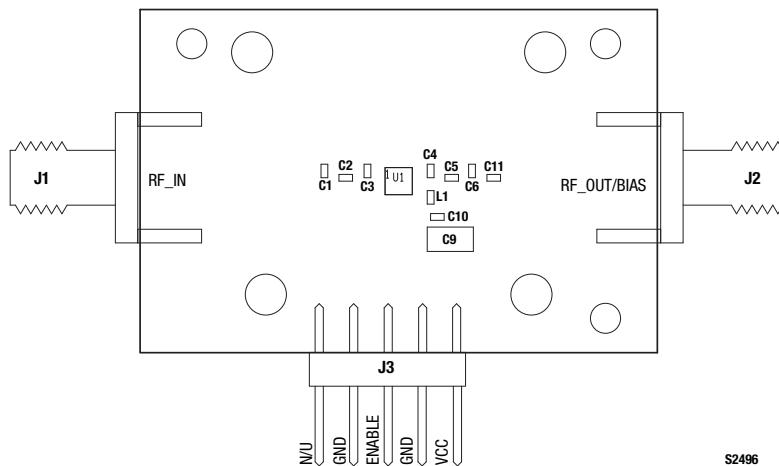
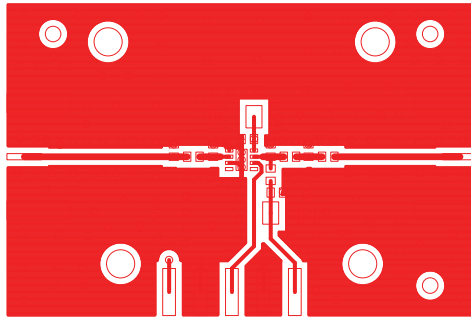
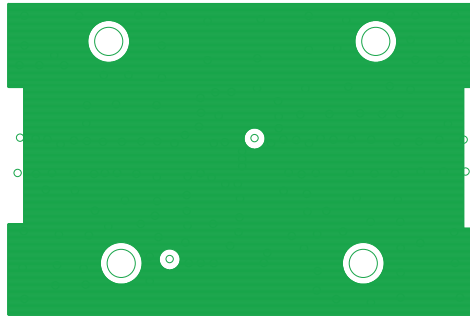


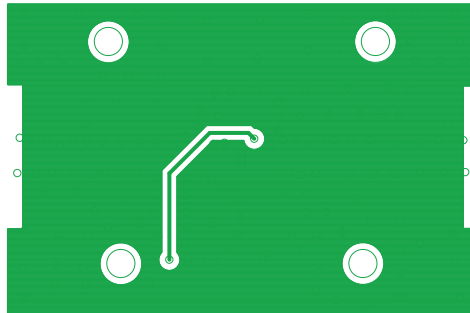
Figure 67. Evaluation Board Assembly Drawing



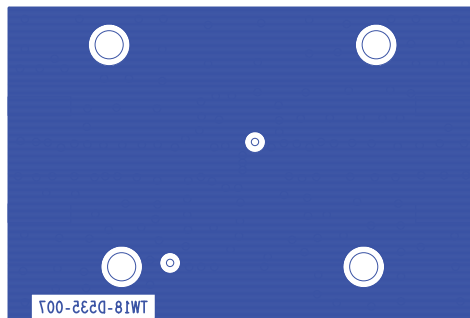
Layer 1: Top – Metal



Layer 2: Ground



Layer 3: Power Plane



Layer 4: Solid Ground Plane

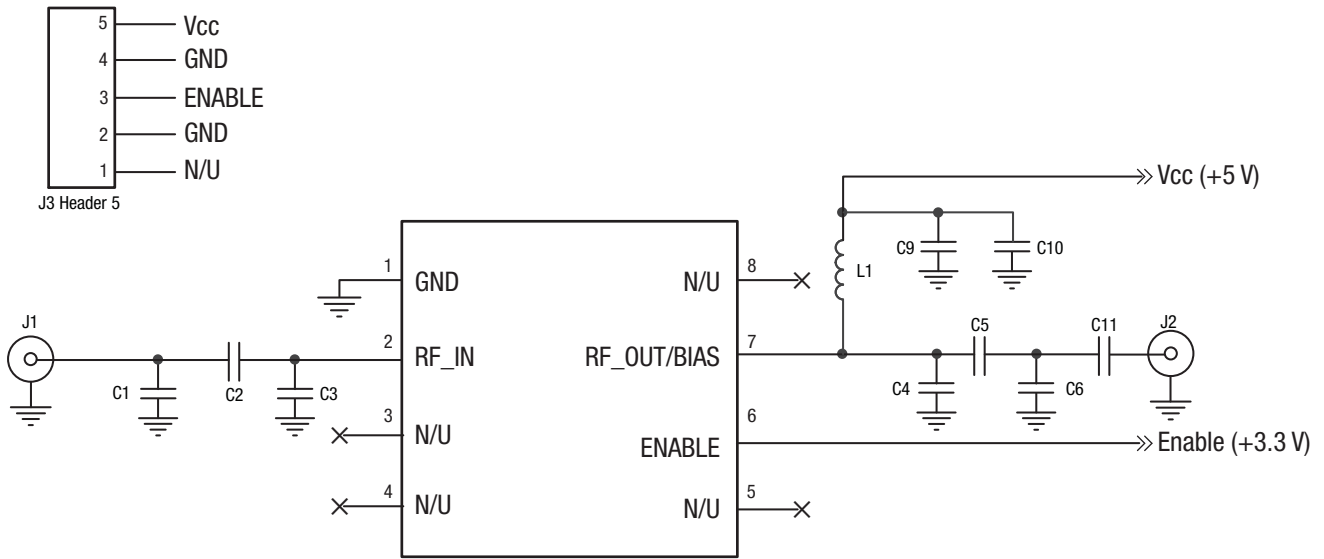
S2497

**Figure 68. Evaluation Board Layer Detail**

Cross Section	Name	Thickness (mm)	Material
	Tmask	0.010	Solder Resist
	L1	0.035	Cu, 1 oz.
	Dielectric	0.250	FR4
	L2	0.035	Cu, 1 oz.
	Dielectric	1.000	FR4
	L3	0.035	Cu, 1 oz.
	Dielectric	0.250	FR4
	L4	0.035	Cu, 1 oz.
	Bmask	0.010	Solder resist

S2097

Figure 69. Layer Detail Physical Characteristics



S2495

Figure 70. SKY65095-360LF Evaluation Board Schematic

**Table 10. SKY65095-360LF (DFN Package) Evaluation Board Bill of Materials (1 of 2)**

Component	Size	Value	Vendor	Vendor Part #
<b>1626 MHz to 1660 MHz</b>				
C1	0402	4.3 pF	Murata	GRM615C0G4R3B50
C2	0402	20 pF	Murata	GRM615C0G200J50
C3	0402	DNI	–	–
C4	0402	2.4 pF	Murata	GRM615C0G2R4B50
C5	0402	3.6 nH	Murata	LQG15HS3N6S02
C6	0402	1.2 pF	Murata	GRM615C0G1R2B50
C9	DNI	–	–	–
C10	0402	1 μF	Murata	GRM155R61A105KE15
C11	0402	20 pF	Murata	GRM615C0G200J50
L1	0402	18 nH	Murata	LQG15HS18NJ02
<b>1710 MHz to 1785 MHz</b>				
C1	0402	3.3 pF	Murata	GRM615C0G3R3B50
C2	0402	20 pF	Murata	GRM615C0G200J50
C3	0402	1.3 pF	Murata	GRM615C0G1R3B50
C4	0402	2.0 pF	Murata	GRM615C0G020B50
C5	0402	3.0 nH	Murata	LQG15HS3N0S02
C6	0402	1.2 pF	Murata	GRM615C0G1R2B50
C9	DNI	–	–	–
C10	0402	1 μF	Murata	GRM155R61A105KE15
C11	0402	20 pF	Murata	GRM615C0G200J50
L1	0402	18 nH	Murata	LQG15HS18NJ02
<b>1850 MHz to 1910 MHz</b>				
C1	0402	2.7 pF	Murata	GRM615C0G2R7B50
C2	0402	20 pF	Murata	GRM615C0G200J50
C3	0402	1.2 pF	Murata	GRM615C0G1R2B50
C4	0402	1.8 pF	Murata	GRM615C0G1R8B50
C5	0402	2.4 nH	Murata	LQG15HS2N4S02
C6	0402	1.5 pF	Murata	GRM615C0G1R5B50
C9	DNI	–	–	–
C10	0402	1 μF	Murata	GRM155R61A105KE15
C11	0402	20 pF	Murata	GRM615C0G200J50
L1	0402	18 nH	Murata	LQG15HS18NJ02

**Table 10. SKY65095-360LF (DFN Package) Evaluation Board Bill of Materials (2 of 2)**

Component	Size	Value	Vendor	Vendor Part #
<b>1920 MHz to 1980 MHz</b>				
C1	0402	2.2 pF	Murata	GRM615C0G2R2B50
C2	0402	20 pF	Murata	GJM1555C1H200JB01
C3	0402	1.8 pF	Murata	GRM615C0G1R8B50
C4	0402	1.8 pF	Murata	GRM615C0G1R8B50
C5	0402	2.0 nH	Murata	LQG15HS2N0S02
C6	0402	1.5 pF	Murata	GRM615C0G1R5B50
C9	DNI	–	–	–
C10	0402	1 $\mu$ F	Murata	GRM155R61A105KE15
C11	0402	20 pF	Murata	GRM615C0G200J50
L1	0402	18 nH	Murata	LQG15HS18NJ02
<b>2010 MHz to 2025 MHz</b>				
C1	0402	1.5 pF	Murata	GRM615C0G1R5B50
C2	0402	20 pF	Murata	GRM615C0G200J50K500
C3	0402	2.4 pF	Murata	GRM615C0G2R4B50
C4	0402	1.0 pF	Murata	GRM615C0G010B50
C5	0402	1.5 nH	Murata	LQG15HS1N5S02
C6	0402	1.5 pF	Murata	GRM615C0G1R5B50
C9	DNI	–	–	–
C10	0402	1 $\mu$ F	Murata	GRM155R61A105KE15
C11	0402	20 pF	Murata	GRM615C0G200J50K500
L1	0402	18 nH	Murata	LQG15HS18NJ02

### Package Dimensions

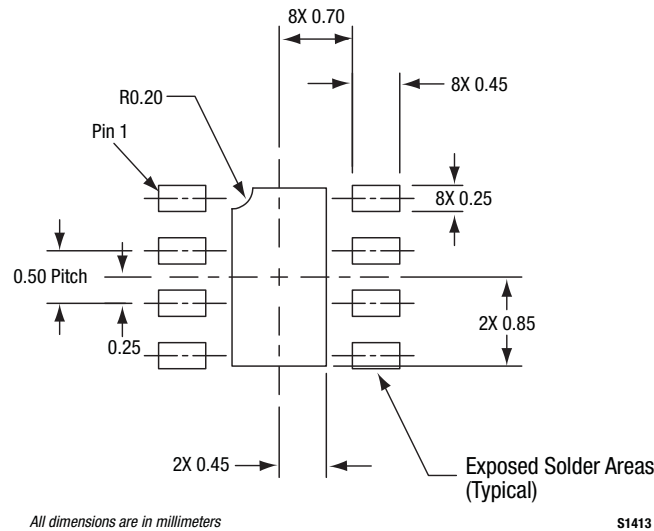
The PCB layout footprint for the SKY65095-360LF is shown in Figure 71. Package dimensions are shown in Figure 72, and tape and reel dimensions are provided in Figure 73.

### Package and Handling Information

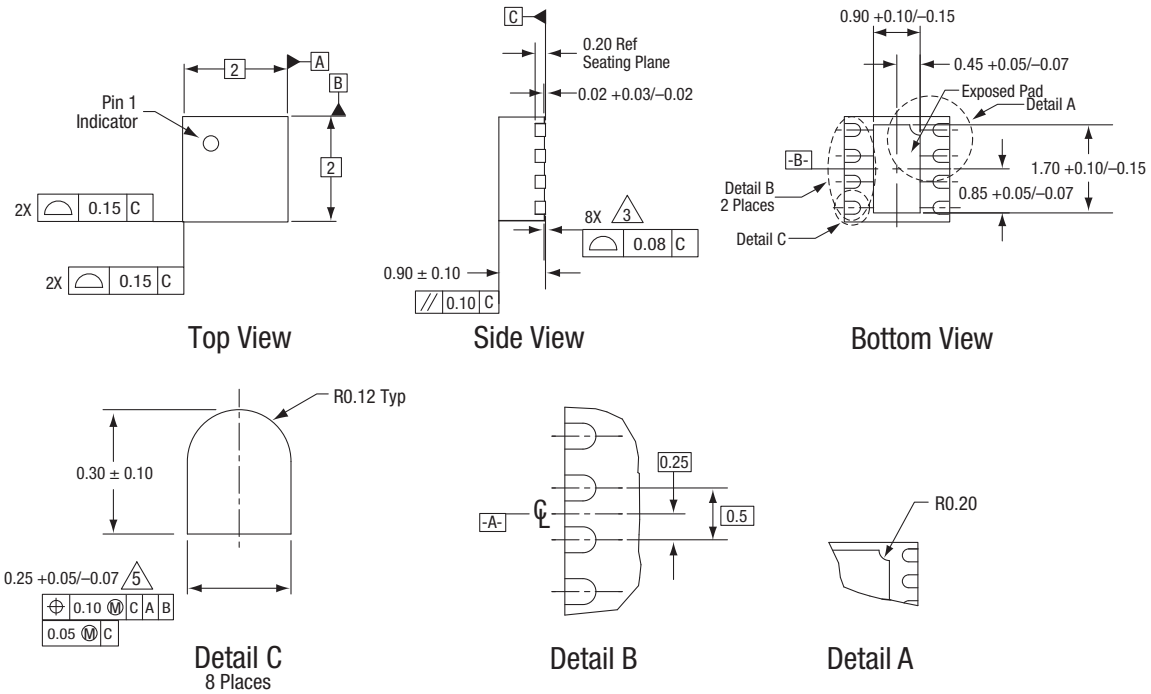
Instructions on the shipping container label regarding exposure to moisture after the container seal is broken must be followed. Otherwise, problems related to moisture absorption may occur when the part is subjected to high temperature during solder assembly.

The SKY65095-360LF is rated to Moisture Sensitivity Level 1 (MSL1) at 260 °C. It can be used for lead or lead-free soldering.

Care must be taken when attaching this product, whether it is done manually or in a production solder reflow environment. Production quantities of this product are shipped in a standard tape and reel format.



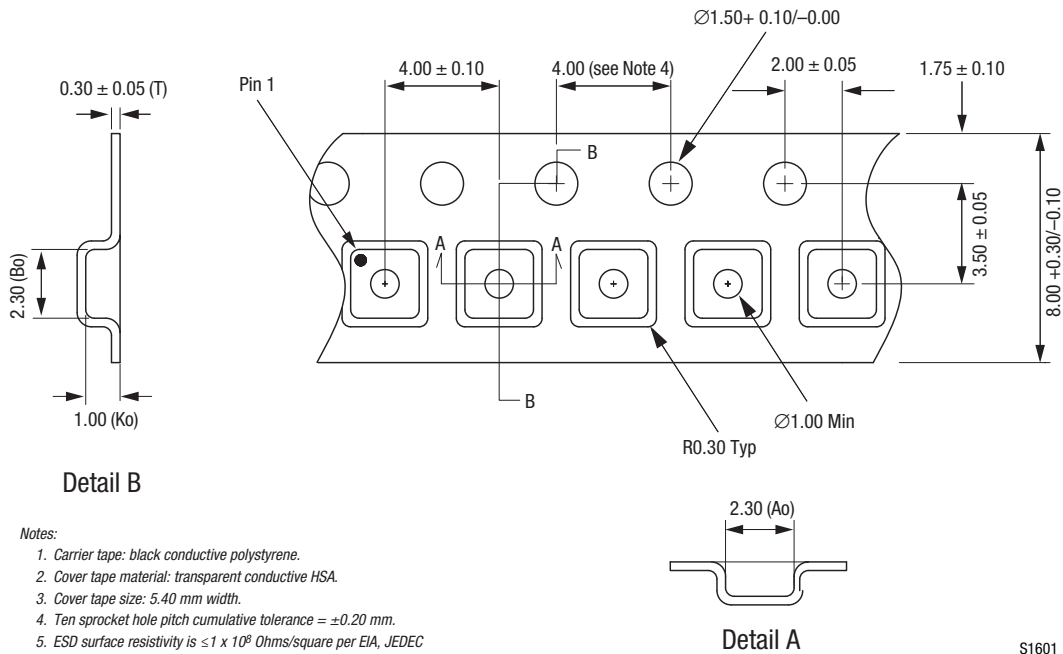
**Figure 71. SKY65095-360LF PCB Layout Footprint**



All measurements are in millimeters.  
 Dimensioning and tolerancing according to ASME Y14.5M-1994.  
 Coplanarity applies to the exposed heat sink slug as well as the terminals.  
 Plating requirement per source control drawing (SCD) 25D4.  
 Dimension applies to metalized terminal and is measured between 0.15 mm and 0.30 mm from terminal tip.

S1415

Figure 72. SKY65095-360LF Package Dimensions



- Notes:
- Carrier tape: black conductive polystyrene.
  - Cover tape material: transparent conductive HSA.
  - Cover tape size: 5.40 mm width.
  - Ten sprocket hole pitch cumulative tolerance = ±0.20 mm.
  - ESD surface resistivity is  $\leq 1 \times 10^8$  Ohms/square per EIA, JEDEC tape and reel specification.
  - Ao and Bo measurement point to be 0.30 mm from bottom pocket.
  - All measurements are in millimeters.

S1601

Figure 73. SKY65095-360LF Tape and Reel Dimensions

## Ordering Information

Model Name	Ordering Part Number	Evaluation Board Part Number
SKY65095-360LF Low Noise PA Driver	SKY65095-360LF	SKY65095-360EK1 (1626 to 1660MHz) SKY65095-360EK2 (1710 to 1785MHz) SKY65095-360EK3 (1850 to 1910MHz) SKY65095-360EK4 (1920 to 1980MHz) SKY65095-360EK5 (2010 to 2025MHz)

Copyright © 2011-2012, 2017 Skyworks Solutions, Inc. All Rights Reserved.

Information in this document is provided in connection with Skyworks Solutions, Inc. (“Skyworks”) products or services. These materials, including the information contained herein, are provided by Skyworks as a service to its customers and may be used for informational purposes only by the customer. Skyworks assumes no responsibility for errors or omissions in these materials or the information contained herein. Skyworks may change its documentation, products, services, specifications or product descriptions at any time, without notice. Skyworks makes no commitment to update the materials or information and shall have no responsibility whatsoever for conflicts, incompatibilities, or other difficulties arising from any future changes.

No license, whether express, implied, by estoppel or otherwise, is granted to any intellectual property rights by this document. Skyworks assumes no liability for any materials, products or information provided hereunder, including the sale, distribution, reproduction or use of Skyworks products, information or materials, except as may be provided in Skyworks Terms and Conditions of Sale.

THE MATERIALS, PRODUCTS AND INFORMATION ARE PROVIDED “AS IS” WITHOUT WARRANTY OF ANY KIND, WHETHER EXPRESS, IMPLIED, STATUTORY, OR OTHERWISE, INCLUDING FITNESS FOR A PARTICULAR PURPOSE OR USE, MERCHANTABILITY, PERFORMANCE, QUALITY OR NON-INFRINGEMENT OF ANY INTELLECTUAL PROPERTY RIGHT; ALL SUCH WARRANTIES ARE HEREBY EXPRESSLY DISCLAIMED. SKYWORKS DOES NOT WARRANT THE ACCURACY OR COMPLETENESS OF THE INFORMATION, TEXT, GRAPHICS OR OTHER ITEMS CONTAINED WITHIN THESE MATERIALS. SKYWORKS SHALL NOT BE LIABLE FOR ANY DAMAGES, INCLUDING BUT NOT LIMITED TO ANY SPECIAL, INDIRECT, INCIDENTAL, STATUTORY, OR CONSEQUENTIAL DAMAGES, INCLUDING WITHOUT LIMITATION, LOST REVENUES OR LOST PROFITS THAT MAY RESULT FROM THE USE OF THE MATERIALS OR INFORMATION, WHETHER OR NOT THE RECIPIENT OF MATERIALS HAS BEEN ADVISED OF THE POSSIBILITY OF SUCH DAMAGE.

Skyworks products are not intended for use in medical, lifesaving or life-sustaining applications, or other equipment in which the failure of the Skyworks products could lead to personal injury, death, physical or environmental damage. Skyworks customers using or selling Skyworks products for use in such applications do so at their own risk and agree to fully indemnify Skyworks for any damages resulting from such improper use or sale.

Customers are responsible for their products and applications using Skyworks products, which may deviate from published specifications as a result of design defects, errors, or operation of products outside of published parameters or design specifications. Customers should include design and operating safeguards to minimize these and other risks. Skyworks assumes no liability for applications assistance, customer product design, or damage to any equipment resulting from the use of Skyworks products outside of stated published specifications or parameters.

Skyworks and the Skyworks symbol are trademarks or registered trademarks of Skyworks Solutions, Inc., in the United States and other countries. Third-party brands and names are for identification purposes only, and are the property of their respective owners. Additional information, including relevant terms and conditions, posted at [www.skyworksinc.com](http://www.skyworksinc.com), are incorporated by reference.



## X-ON Electronics

Largest Supplier of Electrical and Electronic Components

*Click to view similar products for [RF Amplifier](#) category:*

*Click to view products by [Skyworks](#) manufacturer:*

Other Similar products are found below :

[A82-1](#) [BGA622H6820XTSA1](#) [BGA 728L7 E6327](#) [BGB719N7ESDE6327XTMA1](#) [HMC397-SX](#) [HMC405](#) [HMC561-SX](#) [HMC8120-SX](#)  
[HMC8121-SX](#) [HMC-ALH382-SX](#) [HMC-ALH476-SX](#) [SE2433T-R](#) [SMA3101-TL-E](#) [SMA39](#) [A66-1](#) [A66-3](#) [A67-1](#) [A81-2](#) [LX5535LQ](#)  
[LX5540LL](#) [MAAM02350](#) [HMC3653LP3BETR](#) [HMC549MS8GETR](#) [HMC-ALH435-SX](#) [SMA101](#) [SMA32](#) [SMA411](#) [SMA531](#)  
[SST12LP19E-QX6E](#) [WPM0510A](#) [HMC5929LS6TR](#) [HMC5879LS7TR](#) [HMC1087F10](#) [HMC1086](#) [HMC1016](#) [SMA1212](#) [MAX2689EWS+T](#)  
[MAAMSS0041TR](#) [MAAM37000-A1G](#) [LTC6430AIUF-15#PBF](#) [SMA70-2](#) [SMA4011](#) [A231](#) [HMC-AUH232](#) [LX5511LQ](#) [LX5511LQ-TR](#)  
[HMC7441-SX](#) [HMC-ALH310](#) [XD1001-BD-000V](#) [A4011](#)