

DATA SHEET

SKY67153-396LF: 0.7 to 3.8 GHz Ultra Low-Noise Amplifier

Applications

- LTE, GSM, WCDMA, HSDPA macro and micro base stations
- L and S band ultra low-noise receivers
- Cellular repeaters, DAS and RRH/RRUs
- High temperature transceiver applications to +105 °C

Features

- Ultra-low Evaluation Board NF:
 - 0.25 dB @ 849 MHz
 - 0.35 dB @ 1850 MHz
 - 0.50 dB @ 2500 MHz
 - 0.70 dB @ 3600 MHz
- High OIP3 performance: >+34 dBm over 700 to 3800 MHz
- Adjustable supply current from 30 to 100 mA
- Flexible bias voltage: 3 to 5 V
- Temperature and process-stable active bias
- Miniature DFN (8-pin, 2 x 2 mm) package (MSL1 @ 260 °C per JEDEC J-STD-020)



Skyworks Green™ products are compliant with all applicable legislation and are halogen-free. For additional information, refer to *Skyworks Definition of Green™*, document number SQ04-0074.

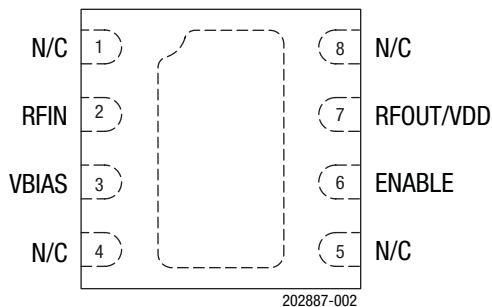

Figure 2. SKY67153-396LF Pinout (Top View)

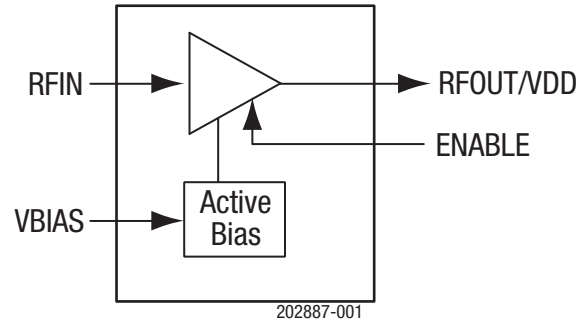

Figure 1. SKY67153-396LF Block Diagram

Description

The SKY67153-396LF is GaAs, pHEMT low-noise amplifier (LNA) with an active bias, high linearity, superior gain, and industry-leading noise figure (NF) performance from 700 to 3800 MHz. The device features Skyworks advanced, pHEMT enhancement mode process in a compact 2 x 2 mm, 8-pin Dual Flat No-Lead (DFN) package.

The internal active bias circuitry provides stable performance over temperature and process variation. The device offers the ability to externally adjust supply current. Supply voltage is applied to the RFOUT/VDD pin through an RF choke inductor. The RFIN and RFOUT/VDD pins should be DC blocked to ensure proper operation.

The SKY67153-396LF operates in the frequency range of 0.7 to 3.8 GHz using a common layout and band-specific tunes.

A functional block diagram is shown in Figure 1. The pin configuration and package are shown in Figure 2. Signal pin assignments and functional pin descriptions are provided in Table 1.

Table 1. SKY67153-396LF Signal Descriptions

| Pin | Name | Description | Pin | Name | Description |
|-----|-------|--|-----|-----------|---|
| 1 | N/C | No connection. May be connected to ground with no change in performance. | 5 | N/C | No connection. May be connected to ground with no change in performance. |
| 2 | RFIN | RF input. DC blocking capacitor required. | 6 | ENABLE | Enable pin. Active low = amplifier "on" state |
| 3 | VBIAS | Bias voltage for input gate. External resistor sets current consumption. | 7 | RFOUT/VDD | RF output. Apply VDD through RF choke inductor. DC blocking capacitor required. |
| 4 | N/C | No connection. May be connected to ground with no change in performance. | 8 | N/C | No connection. May be connected to ground with no change in performance. |

Electrical and Mechanical Specifications

The absolute maximum ratings of the SKY67153-396LF are provided in Table 2. Electrical specifications are provided in Tables 3 through 8.

Typical performance characteristics are illustrated in Figures 3 through 22.

Table 2. SKY67153-396LF Absolute Maximum Ratings¹

| Parameter | Symbol | Minimum | Maximum | Units |
|-------------------------------------|------------------|---------|---------|-------|
| Supply voltage | V _{DD} | | 5.5 | V |
| Quiescent supply current | I _{DQ} | | 120 | mA |
| RF input power | P _{IN} | | +21 | dBm |
| Storage temperature | T _{STG} | -40 | +150 | °C |
| Operating temperature | T _A | -40 | +105 | °C |
| Junction temperature | T _J | | +150 | °C |
| Electrostatic discharge: | ESD | | | |
| Charged Device Model (CDM), Class 4 | | | 1000 | V |
| Human Body Model (HBM), Class 1A | | | 250 | V |
| Machine Model (MM), Class A | | | 30 | V |

¹ Exposure to maximum rating conditions for extended periods may reduce device reliability. There is no damage to device with only one parameter set at the limit and all other parameters set at or below their nominal value. Exceeding any of the limits listed here may result in permanent damage to the device.

ESD HANDLING: *Although this device is designed to be as robust as possible, electrostatic discharge (ESD) can damage this device. This device must be protected at all times from ESD when handling or transporting. Static charges may easily produce potentials of several kilovolts on the human body or equipment, which can discharge without detection. Industry-standard ESD handling precautions should be used at all times.*

Table 3. SKY67153-396LF Electrical Specifications: Thermal Data¹

(V_{DD} = 5 V, T_A = +25 °C, P_{IN} = -25 dBm, Characteristic Impedance [Z₀] = 50 Ω, Unless Otherwise Noted)

| Parameter | Symbol | Test Condition | Min | Typ | Max | Units |
|--|-----------------|--|-----|-----|-----|-------|
| Thermal resistance | Θ _{JC} | | | 45 | | °C/W |
| Channel temperature @ +85 °C reference (package heat slug) | | V _{DD} = 5 V, I _{DQ} = 70 mA, no RF applied, dissipated power = 0.35 W | | 101 | | °C |

¹ Performance is guaranteed only under the conditions listed in this table.

Table 4. SKY67153-396LF Electrical Specifications: 2300 to 2700 MHz Optimized Tuning¹

(V_{DD} = 5 V, T_A = +25 °C, P_{IN} = -20 dBm, Characteristic Impedance [Z₀] = 50 Ω, Unless Otherwise Noted)

| Parameter | Symbol | Test Condition | Min | Typ | Max | Units |
|------------------------------------|---------------------|--|------|------|------|-------|
| RF Specifications | | | | | | |
| Noise figure | NF | @ 2500 MHz, includes Evaluation Board loss | | 0.50 | 0.65 | dB |
| Small signal gain | IS21I | @ 2500 MHz | 17.5 | 19.0 | | dB |
| Input return loss | IS11I | @ 2500 MHz | | 11 | | dB |
| Output return loss | IS22I | @ 2500 MHz | | 20 | | dB |
| Reverse isolation | IS12I | @ 2500 MHz | | 28 | | dB |
| Third order input intercept point | IIP3 | @ 2500 MHz, Δf = 1 MHz, P _{IN} = -20 dBm/tone | +14 | +17 | | dBm |
| Third order output intercept point | OIP3 | @ 2500 MHz, Δf = 1 MHz, P _{IN} = -20 dBm/tone | +33 | +36 | | dBm |
| 1 dB input compression point | IP1dB | @ 2500 MHz | 0 | +2 | | dBm |
| 1 dB output compression point | OP1dB | @ 2500 MHz | +18 | +20 | | dBm |
| DC Specifications | | | | | | |
| Supply voltage | V _{DD} | | | 5 | | V |
| Quiescent supply current | I _{DQ} | Set with external resistor | 58 | 72 | 86 | mA |
| Bias current | I _{BIAS} | | | 500 | | μA |
| Enable voltage: | V _{ENABLE} | | | | | |
| Gain mode | | | 0 | | 0.2 | V |
| Power-down mode | | | 1.5 | | 5.5 | V |
| Enable rise time (Note 2) | T _R | @ 2500 MHz | | 250 | 500 | ns |
| Enable fall time (Note 2) | T _F | @ 2500 MHz | | 250 | 500 | ns |

¹ Performance is guaranteed only under the conditions listed in this table.

² Tested with a 100 kHz square wave, 1000 pF capacitance-to-ground on the ENABLE pin. Switching time can be improved by reducing the value of, or eliminating, the 1000 pF capacitor on pin 6 (component M17 in Figure 25).

Typical Performance Characteristics, 2300 to 2700 MHz

(VDD = 5 V, TA = +25 °C, PIN = -20 dBm, Characteristic Impedance [Zo] = 50 Ω, Unless Otherwise Noted)

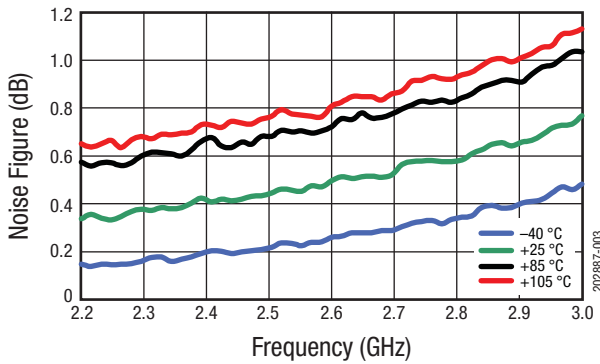

Figure 3. Evaluation board NF vs Frequency over Temperature

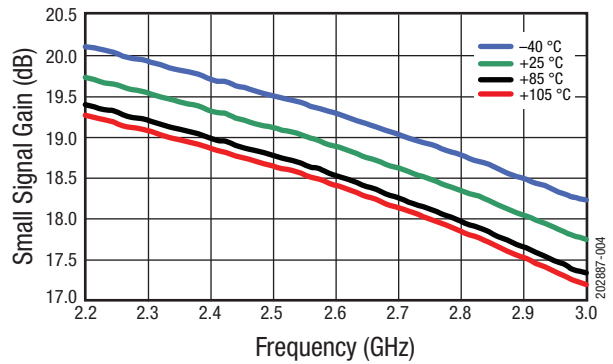

Figure 4. Narrow Band Gain vs Frequency over Temperature

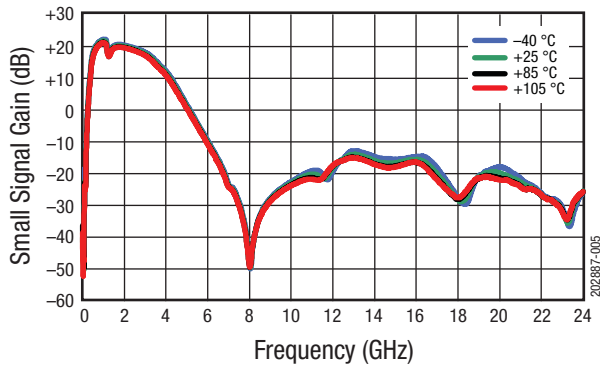

Figure 5. Broadband Gain vs Frequency over Temperature

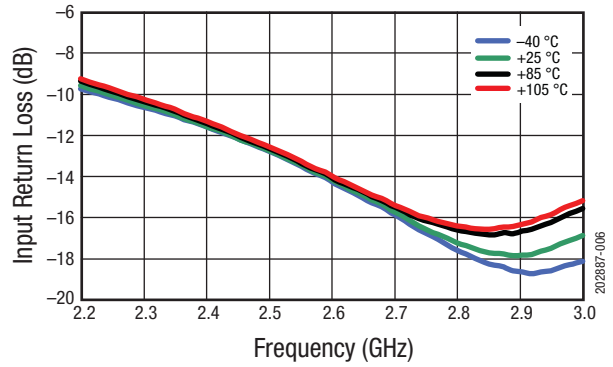

Figure 6. Narrowband Input Return Loss vs Frequency over Temperature

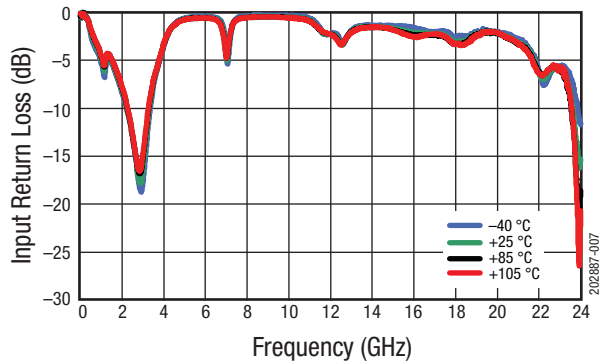

Figure 7. Broadband Input Return Loss vs Frequency over Temperature

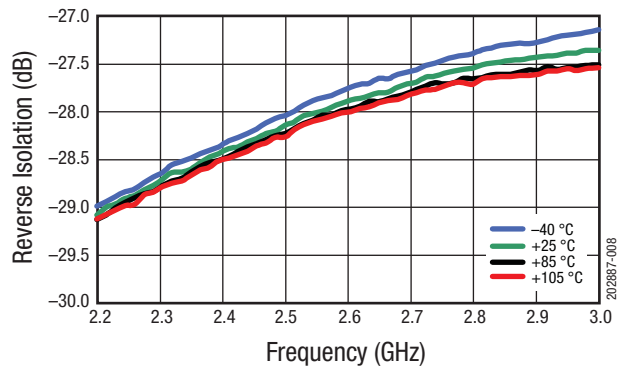

Figure 8. Narrowband Reverse Isolation vs Frequency over Temperature

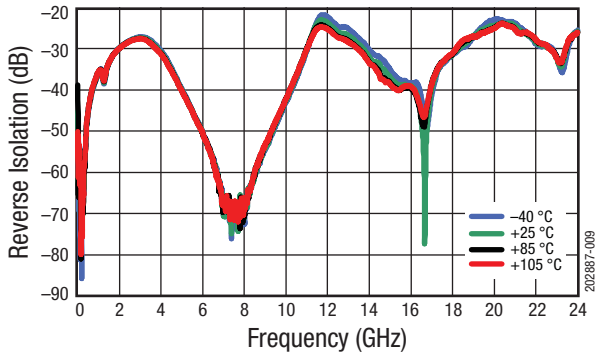

Figure 9. Broadband Reverse Isolation vs Frequency over Temperature

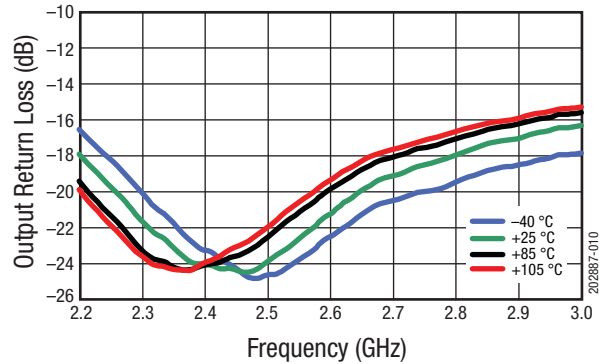

Figure 10. Narrowband Output Return Loss vs Frequency over Temperature

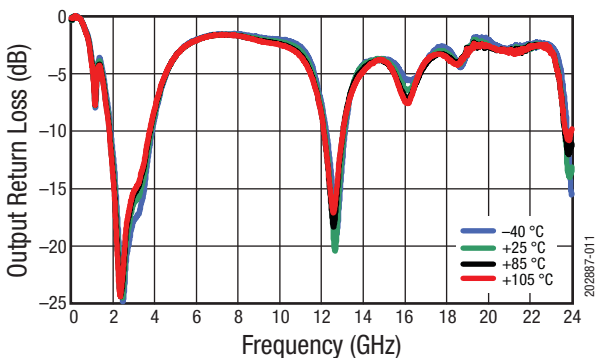

Figure 11. Broadband Output Return Loss vs Frequency over Temperature

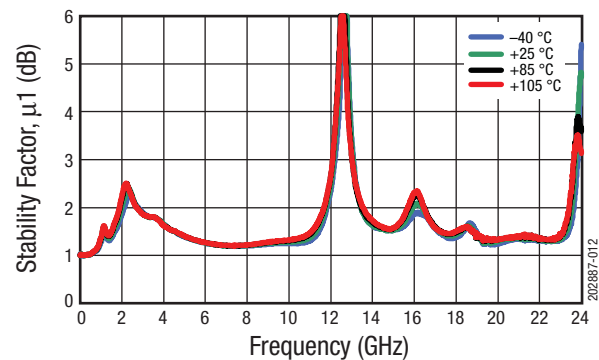

Figure 12. Stability Factor (μ_1) vs Frequency over Temperature

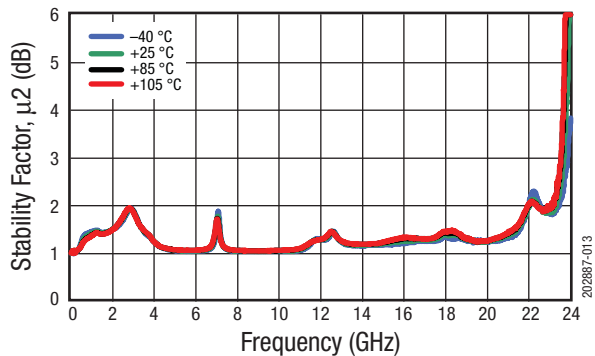

Figure 13. Stability Factor (μ_2) vs Frequency over Temperature

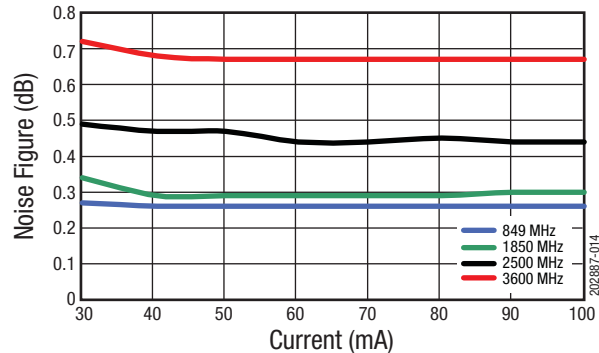

Figure 14. Evaluation Board NF vs Quiescent Current over Frequency Using Band-Specific BOM

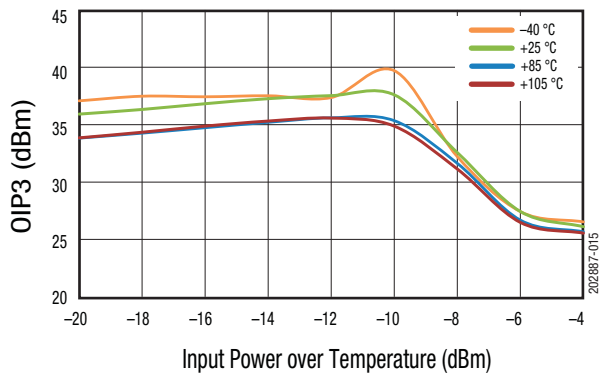

Figure 15. OIP3 vs Input Power over Temperature (@2500 MHz, 1MHz Spacing)

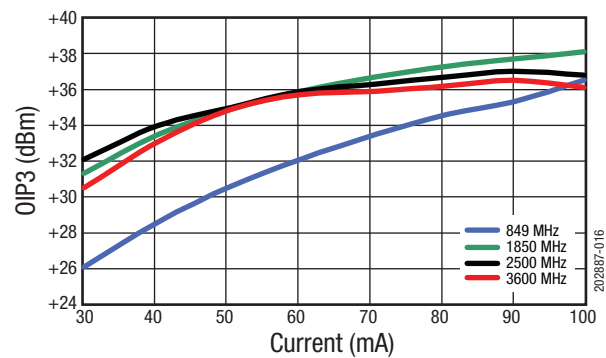

Figure 16. OIP3 vs Quiescent Current over Frequency Using Band-Specific BOM

Table 5. SKY67153-396LF Electrical Specifications: 700 to 1000 MHz Optimized Tuning¹
(V_{DD} = 5 V, T_A = +25 °C, P_{IN} = -25 dBm, Characteristic Impedance [Z₀] = 50 Ω, Unless Otherwise Noted)

| Parameter | Symbol | Test Condition | Min | Typical | Max | Units |
|------------------------------------|---------------------|---|-------|---------|------|-------|
| RF Specifications | | | | | | |
| Noise figure | NF | @ 849 MHz, includes Evaluation Board loss | | 0.25 | 0.40 | dB |
| Small signal gain | IS21I | @ 849 MHz | 24.5 | 26.0 | | dB |
| Input return loss | IS11I | @ 849 MHz | | 12 | | dB |
| Output return loss | IS22I | @ 849 MHz | | 18 | | dB |
| Reverse isolation | IS12I | @ 849 MHz | | 33 | | dB |
| Third order input intercept point | IIP3 | @ 849 MHz, Δf = 1 MHz, P _{IN} = -25 dBm/tone | +5.5 | +8.5 | | dBm |
| Third order output intercept point | OIP3 | @ 849 MHz, Δf = 1 MHz, P _{IN} = -25 dBm/tone | +31.5 | +34.5 | | dBm |
| 1 dB input compression point | IP1dB | @ 849 MHz | -5.5 | -3.5 | | dBm |
| 1 dB output compression point | OP1dB | @ 849 MHz | +19.5 | +21.5 | | dBm |
| DC Specifications | | | | | | |
| Supply voltage | V _{DD} | | | 5 | | V |
| Quiescent supply current | I _{DQ} | Set with external resistor | | 80 | | mA |
| Bias current | I _{BIAS} | | | 500 | | μA |
| Enable voltage: | V _{ENABLE} | | | | | |
| Gain mode | | | 0 | | 0.2 | V |
| Power-down mode | | | 1.5 | | 5.5 | V |
| Enable rise time ² | T _R | @ 849 MHz | | 250 | 500 | ns |
| Enable fall time ² | T _F | @ 849 MHz | | 250 | 500 | ns |

¹ Performance is guaranteed only under the conditions listed in this table.

² Tested with a 100 kHz square wave, 1000 pF capacitance-to-ground on the ENABLE pin. Switching time can be improved by reducing the value of, or eliminating, the 1000 pF capacitor on pin 6 (component M17 in Figure 25).

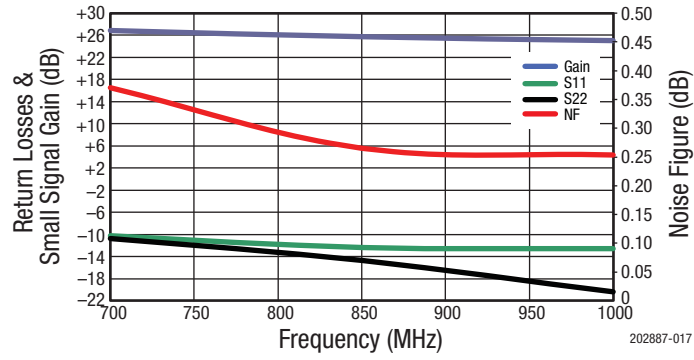

Figure 17. Evaluation Board NF, Gain, and Return Losses for 700 to 1000 MHz Tuning

Table 6. SKY67153-396LF Electrical Specifications: 1600 to 2170 MHz Optimized Tuning (Note 1)
 ($V_{DD} = 5\text{ V}$, $T_A = +25\text{ }^\circ\text{C}$, $P_{IN} = -20\text{ dBm}$, Characteristic Impedance [Z_0] = $50\ \Omega$, Unless Otherwise Noted)

| Parameter | Symbol | Test Condition | Min | Typical | Max | Units |
|---|--------------|---|----------|---------|------------|---------------|
| RF Specifications | | | | | | |
| Noise figure | NF | @ 1850 MHz, includes Evaluation Board loss | | 0.35 | 0.50 | dB |
| Small signal gain | IS21I | @ 1850 MHz | 19.0 | 20.5 | | dB |
| Input return loss | IS11I | @ 1850 MHz | | 12 | | dB |
| Output return loss | IS22I | @ 1850 MHz | | 16 | | dB |
| Reverse isolation | IS12I | @ 1850 MHz | | 29 | | dB |
| Third order input intercept point | IIP3 | @ 1850 MHz, $\Delta f = 1\text{ MHz}$, $P_{IN} = -20\text{ dBm/ tone}$ | +12.5 | +15.5 | | dBm |
| Third order output intercept point | OIP3 | @ 1850 MHz, $\Delta f = 1\text{ MHz}$, $P_{IN} = -20\text{ dBm/ tone}$ | +33 | +36 | | dBm |
| 1 dB input compression point | IP1dB | @ 1850 MHz | -1 | +1 | | dBm |
| 1 dB output compression point | OP1dB | @ 1850 MHz | +18.5 | +20.5 | | dBm |
| DC Specifications | | | | | | |
| Supply voltage | V_{DD} | | | 5 | | V |
| Quiescent supply current | I_{DQ} | Set with external resistor | | 70 | | mA |
| Bias current | I_{BIAS} | | | 500 | | μA |
| Enable voltage: Gain mode Power-down mode | V_{ENABLE} | | 0 1.5 | | 0.2 5.5 | V V |
| Enable rise time (Note 2) | T_R | @ 1850 MHz | | 250 | 500 | ns |
| Enable fall time (Note 2) | T_F | @ 1850 MHz | | 250 | 500 | ns |

¹ Performance is guaranteed only under the conditions listed in this table.

² Tested with a 100 kHz square wave, 1000 pF capacitance-to-ground on the ENABLE pin. Switching time can be improved by reducing the value of, or eliminating, the 1000 pF capacitor on pin 6 (component M17 in Figure 25).

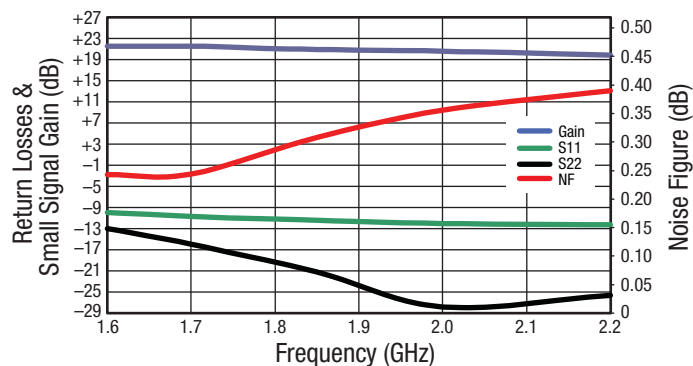

Figure 18. Evaluation Board NF, Gain, and Return Losses for 1.6 to 2.2 GHz Tuning

Table 7. SKY67153-396LF Electrical Specifications: 3400 to 3800 MHz Optimized Tuning (Note 1)
(V_{DD} = 5 V, T_A = +25 °C, P_{IN} = -20 dBm, Characteristic Impedance [Z₀] = 50 Ω, Unless Otherwise Noted)

| Parameter | Symbol | Test Condition | Min | Typ | Max | Units |
|------------------------------------|---------------------|--|-------|-------|------|-------|
| RF Specifications | | | | | | |
| Noise figure | NF | @ 3600 MHz, includes Evaluation Board loss | | 0.70 | 0.90 | dB |
| Small signal gain | IS21I | @ 3600 MHz | 14.5 | 16.5 | | dB |
| Input return loss | IS11I | @ 3600 MHz | | 10 | | dB |
| Output return loss | IS22I | @ 3600 MHz | | 16 | | dB |
| Reverse isolation | IS12I | @ 3600 MHz | | 28 | | dB |
| Third order input intercept point | IIP3 | @ 3600 MHz, Δf = 1 MHz, P _{IN} = -20 dBm/tone | +16.5 | +19.5 | | dBm |
| Third order output intercept point | OIP3 | @ 3600 MHz, Δf = 1 MHz, P _{IN} = -20 dBm/tone | +33 | +36 | | dBm |
| 1 dB input compression point | IP1dB | @ 3600 MHz | +0.5 | +2.5 | | dBm |
| 1 dB output compression point | OP1dB | @ 3600 MHz | +16 | +18 | | dBm |
| DC Specifications | | | | | | |
| Supply voltage | V _{DD} | | | 5 | | V |
| Quiescent supply current | I _{DQ} | Set with external resistor | | 80 | | mA |
| Bias current | I _{BIAS} | | | 500 | | μA |
| Enable voltage: Gain mode | V _{ENABLE} | | 0 | | 0.2 | V |
| Power-down mode | | | 1.5 | | 5.5 | V |
| Enable rise time ² | T _R | @ 3600 MHz | | 250 | 500 | ns |
| Enable fall time ² | T _F | @ 3600 MHz | | 250 | 500 | ns |

¹ Performance is guaranteed only under the conditions listed in this table.

² Tested with a 100 kHz square wave, 1000 pF capacitance-to-ground on the ENABLE pin. Switching time can be improved by reducing the value of, or eliminating, the 1000 pF capacitor on pin 6 (component M17 in Figure 25).

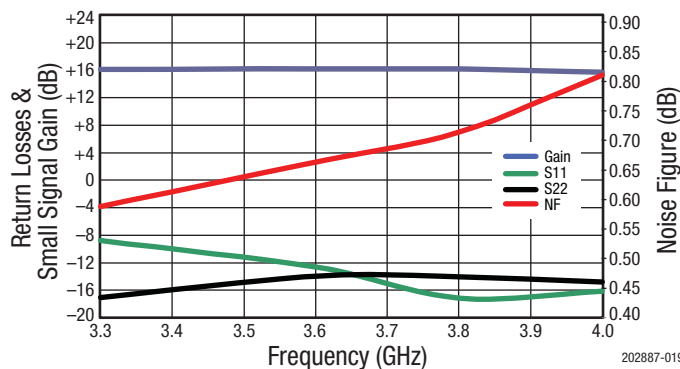

Figure 19. Evaluation Board NF, Gain, and Return Losses for 3.3 to 4.0 GHz Tuning

Table 8. Noise Parameters vs Frequency (@ +25 °C, 5 V, 70 mA) (1 of 3)

| Frequency (MHz) | F _{MIN} (dB) | Gamma opt (Mag) | Gamma opt (Phase) | Noise Resistance (R _N) (Ω) | Associated Gain (dB) | Maximum Gain (G _{MAX}) (dB) |
|-----------------|-----------------------|-----------------|-------------------|--|----------------------|---------------------------------------|
| 400 | 0.33 | 0.40 | 7.69 | 0.06 | 29.58 | 31.69 |
| 450 | 0.31 | 0.37 | 13.49 | 0.06 | 29.19 | 31.12 |
| 500 | 0.30 | 0.35 | 19.08 | 0.05 | 28.81 | 30.58 |
| 550 | 0.29 | 0.33 | 24.47 | 0.05 | 28.44 | 30.05 |
| 600 | 0.28 | 0.31 | 29.66 | 0.05 | 28.07 | 29.55 |
| 650 | 0.27 | 0.29 | 34.66 | 0.05 | 27.72 | 29.06 |
| 700 | 0.26 | 0.27 | 39.48 | 0.05 | 27.38 | 28.60 |
| 750 | 0.25 | 0.26 | 44.13 | 0.04 | 27.04 | 28.16 |
| 800 | 0.25 | 0.25 | 48.60 | 0.04 | 26.72 | 27.73 |
| 850 | 0.24 | 0.23 | 52.92 | 0.04 | 26.40 | 27.32 |
| 900 | 0.24 | 0.22 | 57.08 | 0.04 | 26.09 | 26.93 |
| 950 | 0.23 | 0.21 | 61.09 | 0.04 | 25.79 | 26.55 |
| 1000 | 0.23 | 0.20 | 64.96 | 0.04 | 25.50 | 26.19 |
| 1050 | 0.23 | 0.20 | 68.69 | 0.04 | 25.22 | 25.84 |
| 1100 | 0.23 | 0.19 | 72.29 | 0.03 | 24.94 | 25.51 |
| 1150 | 0.23 | 0.19 | 75.77 | 0.03 | 24.67 | 25.19 |
| 1200 | 0.23 | 0.18 | 79.12 | 0.03 | 24.41 | 24.89 |
| 1250 | 0.23 | 0.18 | 82.37 | 0.03 | 24.16 | 24.60 |
| 1300 | 0.24 | 0.18 | 85.51 | 0.03 | 23.91 | 24.32 |
| 1350 | 0.24 | 0.17 | 88.54 | 0.03 | 23.67 | 24.05 |
| 1400 | 0.24 | 0.17 | 91.48 | 0.03 | 23.43 | 23.79 |
| 1450 | 0.25 | 0.17 | 94.33 | 0.03 | 23.21 | 23.55 |
| 1500 | 0.25 | 0.17 | 97.09 | 0.03 | 22.98 | 23.31 |
| 1550 | 0.25 | 0.17 | 99.76 | 0.03 | 22.77 | 23.08 |
| 1600 | 0.26 | 0.18 | 102.36 | 0.03 | 22.56 | 22.87 |
| 1650 | 0.27 | 0.18 | 104.89 | 0.03 | 22.35 | 22.66 |
| 1700 | 0.27 | 0.18 | 107.35 | 0.03 | 22.15 | 22.46 |
| 1750 | 0.28 | 0.19 | 109.74 | 0.03 | 21.96 | 22.27 |
| 1800 | 0.28 | 0.19 | 112.08 | 0.03 | 21.77 | 22.08 |
| 1850 | 0.29 | 0.19 | 114.36 | 0.03 | 21.59 | 21.90 |
| 1900 | 0.30 | 0.20 | 116.58 | 0.03 | 21.41 | 21.73 |
| 1950 | 0.31 | 0.20 | 118.76 | 0.03 | 21.23 | 21.57 |
| 2000 | 0.31 | 0.21 | 120.89 | 0.03 | 21.06 | 21.41 |
| 2050 | 0.32 | 0.22 | 122.99 | 0.03 | 20.90 | 21.26 |
| 2100 | 0.33 | 0.22 | 125.04 | 0.03 | 20.74 | 21.11 |
| 2150 | 0.34 | 0.23 | 127.06 | 0.03 | 20.58 | 20.97 |
| 2200 | 0.35 | 0.24 | 129.05 | 0.03 | 20.42 | 20.83 |
| 2250 | 0.36 | 0.24 | 131.00 | 0.03 | 20.27 | 20.69 |

Table 8. Noise Parameters vs Frequency (@ +25 °C, 5 V, 70 mA) (2 of 3)

| Frequency (MHz) | F _{MIN} (dB) | Gamma opt (Mag) | Gamma opt (Phase) | Noise Resistance (R _N) (Ω) | Associated Gain (dB) | Maximum Gain (G _{MAX}) (dB) |
|-----------------|-----------------------|-----------------|-------------------|--|----------------------|---------------------------------------|
| 2300 | 0.37 | 0.25 | 132.94 | 0.03 | 20.13 | 20.56 |
| 2350 | 0.37 | 0.26 | 134.85 | 0.03 | 19.99 | 20.44 |
| 2400 | 0.38 | 0.26 | 136.74 | 0.03 | 19.85 | 20.31 |
| 2450 | 0.39 | 0.27 | 138.61 | 0.03 | 19.71 | 20.19 |
| 2500 | 0.40 | 0.28 | 140.46 | 0.03 | 19.58 | 20.07 |
| 2550 | 0.41 | 0.29 | 142.31 | 0.03 | 19.45 | 19.96 |
| 2600 | 0.42 | 0.29 | 144.14 | 0.03 | 19.32 | 19.85 |
| 2650 | 0.43 | 0.30 | 145.96 | 0.03 | 19.19 | 19.74 |
| 2700 | 0.44 | 0.31 | 147.77 | 0.03 | 19.07 | 19.63 |
| 2750 | 0.45 | 0.32 | 149.57 | 0.03 | 18.95 | 19.52 |
| 2800 | 0.45 | 0.32 | 151.37 | 0.03 | 18.84 | 19.42 |
| 2850 | 0.46 | 0.33 | 153.17 | 0.03 | 18.72 | 19.32 |
| 2900 | 0.47 | 0.34 | 154.97 | 0.03 | 18.61 | 19.21 |
| 2950 | 0.48 | 0.34 | 156.76 | 0.03 | 18.50 | 19.11 |
| 3000 | 0.49 | 0.35 | 158.55 | 0.03 | 18.39 | 19.02 |
| 3050 | 0.50 | 0.36 | 160.35 | 0.03 | 18.29 | 18.92 |
| 3100 | 0.51 | 0.36 | 162.14 | 0.03 | 18.18 | 18.82 |
| 3150 | 0.51 | 0.37 | 163.94 | 0.04 | 18.08 | 18.72 |
| 3200 | 0.52 | 0.38 | 165.74 | 0.04 | 17.98 | 18.63 |
| 3250 | 0.53 | 0.38 | 167.54 | 0.04 | 17.89 | 18.53 |
| 3300 | 0.54 | 0.39 | 169.35 | 0.04 | 17.79 | 18.44 |
| 3350 | 0.55 | 0.39 | 171.16 | 0.04 | 17.69 | 18.34 |
| 3400 | 0.55 | 0.40 | 172.97 | 0.04 | 17.60 | 18.25 |
| 3450 | 0.56 | 0.41 | 174.78 | 0.04 | 17.51 | 18.15 |
| 3500 | 0.57 | 0.41 | 176.59 | 0.04 | 17.42 | 18.06 |
| 3550 | 0.58 | 0.42 | 178.41 | 0.04 | 17.33 | 17.97 |
| 3600 | 0.58 | 0.42 | -179.77 | 0.04 | 17.24 | 17.87 |
| 3650 | 0.59 | 0.43 | -177.96 | 0.04 | 17.16 | 17.78 |
| 3700 | 0.60 | 0.43 | -176.14 | 0.04 | 17.07 | 17.69 |
| 3750 | 0.60 | 0.43 | -174.33 | 0.04 | 16.99 | 17.60 |
| 3800 | 0.61 | 0.44 | -172.52 | 0.04 | 16.91 | 17.51 |
| 3850 | 0.62 | 0.44 | -170.71 | 0.04 | 16.83 | 17.42 |
| 3900 | 0.62 | 0.45 | -168.91 | 0.04 | 16.75 | 17.33 |
| 3950 | 0.63 | 0.45 | -167.11 | 0.04 | 16.67 | 17.25 |
| 4000 | 0.64 | 0.45 | -165.33 | 0.04 | 16.59 | 17.16 |
| 4050 | 0.64 | 0.46 | -163.55 | 0.04 | 16.52 | 17.07 |
| 4100 | 0.65 | 0.46 | -161.79 | 0.04 | 16.44 | 16.99 |
| 4150 | 0.66 | 0.46 | -160.05 | 0.04 | 16.37 | 16.91 |

Table 8. Noise Parameters vs Frequency (@ +25 °C, 5 V, 70 mA) (3 of 3)

| Frequency (MHz) | FMIN (dB) | Gamma opt (Mag) | Gamma opt (Phase) | Noise Resistance (RN) (Ω) | Associated Gain (dB) | Maximum Gain (GMAX) (dB) |
|-----------------|-----------|-----------------|-------------------|---------------------------|----------------------|--------------------------|
| 4200 | 0.66 | 0.46 | -158.32 | 0.04 | 16.30 | 16.83 |
| 4250 | 0.67 | 0.47 | -156.61 | 0.04 | 16.23 | 16.75 |
| 4300 | 0.68 | 0.47 | -154.92 | 0.04 | 16.15 | 16.67 |
| 4350 | 0.68 | 0.47 | -153.26 | 0.04 | 16.09 | 16.60 |
| 4400 | 0.69 | 0.47 | -151.62 | 0.04 | 16.02 | 16.52 |
| 4450 | 0.70 | 0.47 | -150.02 | 0.04 | 15.95 | 16.45 |
| 4500 | 0.70 | 0.48 | -148.45 | 0.04 | 15.89 | 16.39 |
| 4550 | 0.71 | 0.48 | -146.91 | 0.04 | 15.82 | 16.32 |
| 4600 | 0.72 | 0.48 | -145.42 | 0.04 | 15.76 | 16.26 |
| 4650 | 0.72 | 0.48 | -143.96 | 0.04 | 15.70 | 16.20 |
| 4700 | 0.73 | 0.48 | -142.56 | 0.04 | 15.64 | 16.15 |
| 4750 | 0.74 | 0.49 | -141.21 | 0.04 | 15.58 | 16.10 |
| 4800 | 0.74 | 0.49 | -139.91 | 0.05 | 15.52 | 16.06 |
| 4850 | 0.75 | 0.49 | -138.66 | 0.05 | 15.46 | 16.02 |
| 4900 | 0.76 | 0.49 | -137.48 | 0.05 | 15.41 | 15.98 |
| 4950 | 0.77 | 0.49 | -136.37 | 0.05 | 15.35 | 15.95 |
| 5000 | 0.78 | 0.50 | -135.33 | 0.05 | 15.30 | 15.93 |
| 5050 | 0.79 | 0.50 | -134.36 | 0.05 | 15.25 | 15.91 |
| 5100 | 0.80 | 0.50 | -133.48 | 0.05 | 15.20 | 15.90 |
| 5150 | 0.81 | 0.51 | -132.68 | 0.06 | 15.15 | 15.90 |
| 5200 | 0.82 | 0.51 | -131.97 | 0.06 | 15.11 | 15.90 |
| 5250 | 0.83 | 0.51 | -131.35 | 0.06 | 15.06 | 15.92 |
| 5300 | 0.84 | 0.52 | -130.83 | 0.06 | 15.02 | 15.94 |
| 5350 | 0.85 | 0.52 | -130.42 | 0.06 | 14.98 | 15.97 |
| 5400 | 0.86 | 0.53 | -130.12 | 0.07 | 14.94 | 16.00 |
| 5450 | 0.88 | 0.53 | -129.94 | 0.07 | 14.91 | 16.05 |
| 5500 | 0.89 | 0.54 | -129.88 | 0.07 | 14.87 | 16.11 |
| 5550 | 0.90 | 0.54 | -129.95 | 0.07 | 14.84 | 16.18 |
| 5600 | 0.92 | 0.55 | -130.15 | 0.08 | 14.81 | 16.25 |
| 5650 | 0.93 | 0.56 | -130.49 | 0.08 | 14.79 | 16.35 |
| 5700 | 0.95 | 0.56 | -130.97 | 0.08 | 14.76 | 16.45 |
| 5750 | 0.97 | 0.57 | -131.61 | 0.09 | 14.74 | 16.56 |
| 5800 | 0.99 | 0.58 | -132.41 | 0.09 | 14.72 | 16.69 |
| 5850 | 1.01 | 0.59 | -133.37 | 0.10 | 14.71 | 16.83 |
| 5900 | 1.03 | 0.60 | -134.51 | 0.10 | 14.70 | 16.99 |
| 5950 | 1.05 | 0.61 | -135.82 | 0.11 | 14.69 | 17.16 |
| 6000 | 1.07 | 0.62 | -137.33 | 0.11 | 14.68 | 17.35 |

Swept F1 Load Gamma Pull
 Freq = 0.8000 GHz
 Γ Source: 0.2895 < 41.39

Gt max = 27.19 dB
 at 0.0662 < -167.01
 5 contours, 1.00 dB step
 (23.00 to 27.00 dB)
 Ip3 max = 39.78 dBm
 at 0.4189 < 92.49
 5 contours, 0.50 dBm step
 (37.50 to 39.50 dBm)
 Specs: OFF

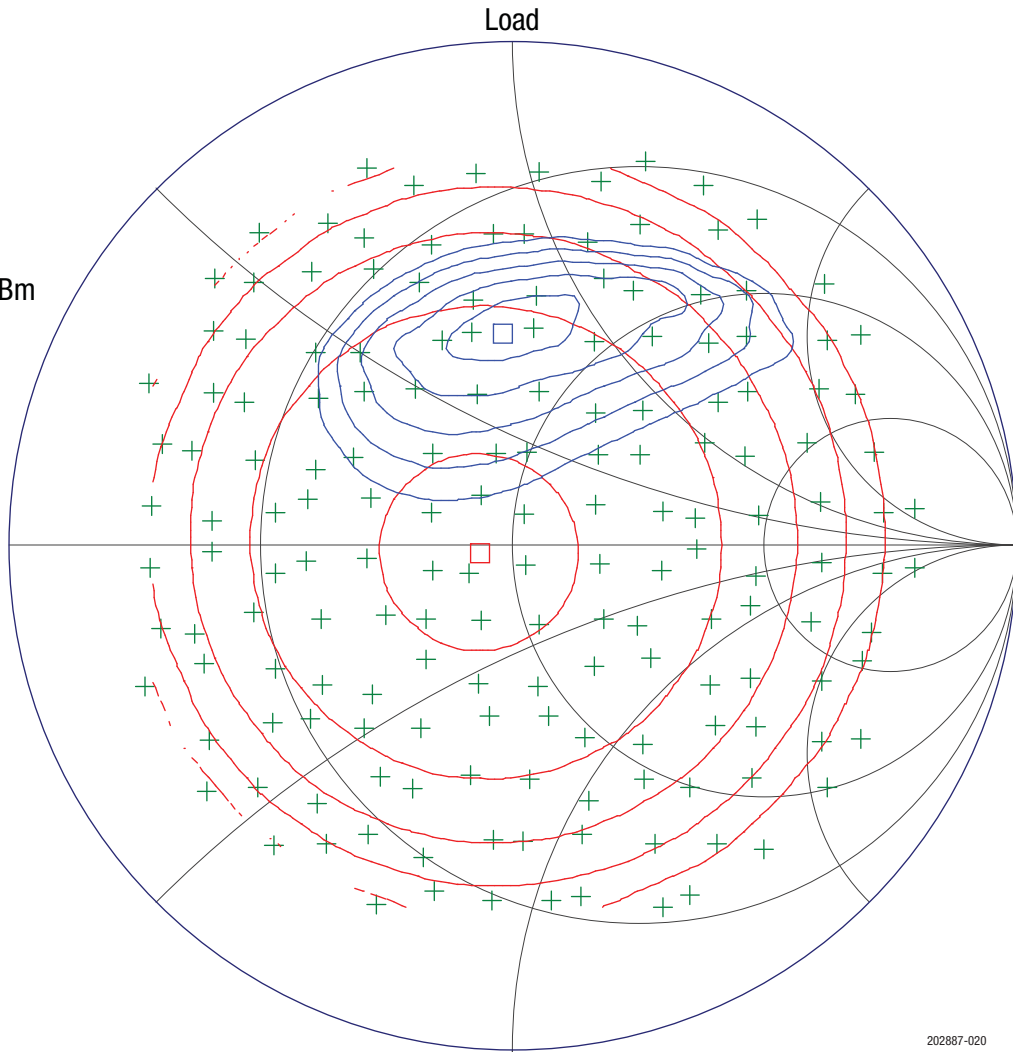

202887-020

Figure 20. OIP3 Load Pull @ 800 MHz, 5 V, 70 mA (Input Load = Min NF, -20 dBm/tone, 5 MHz Spacing)

Swept F1 Load Gamma Pull
 Freq = 1.9000 GHz
 Γ Source: 0.4452 <116.76

Gt max = 21.87 dB
 at 0.2799 <-122.61
 5 contours, 1.00 dB step
 (17.00 to 21.00 dB)
 Ip3 max = 38.34 dBm
 at 0.3369 <176.95
 5 contours, 0.50 dBm step
 (36.00 to 38.00 dBm)
 Specs: OFF

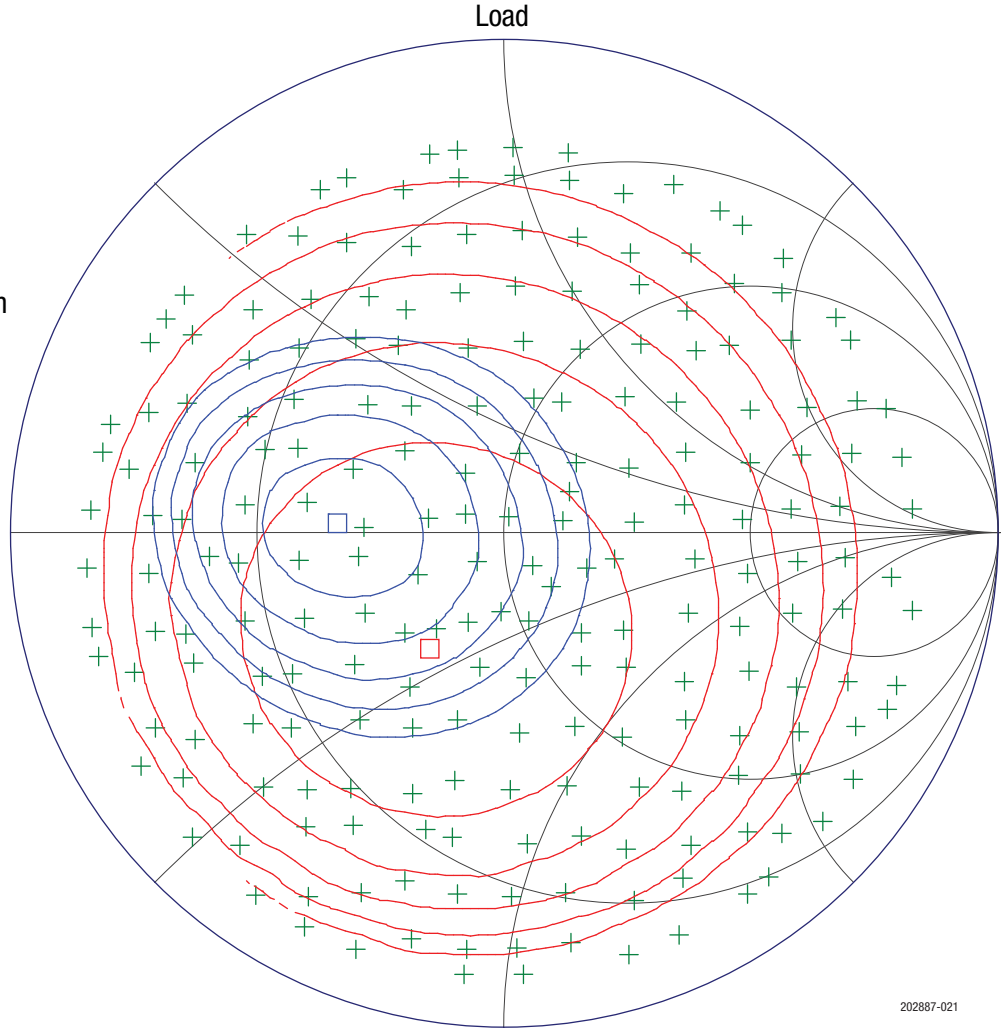

202887-021

Figure 21. OIP3 Load Pull @ 1900 MHz, 5 V, 70 mA (Input Load = Min NF, -20 dBm/tone, 5 MHz Spacing)

Swept F1 Load Gamma Pull
 Freq = 2.6000 GHz
 Γ Source: 0.2658 <143.41

Gt max = 19.48 dB
 at 0.3518 < 70.99
 5 contours, 1.00 dB step
 (15.00 to 19.00 dB)
 Ip3 max = 36.89 dBm
 at 0.1195 < 142.13
 5 contours, 0.50 dBm step
 (34.50 to 36.50 dBm)
 Specs: OFF

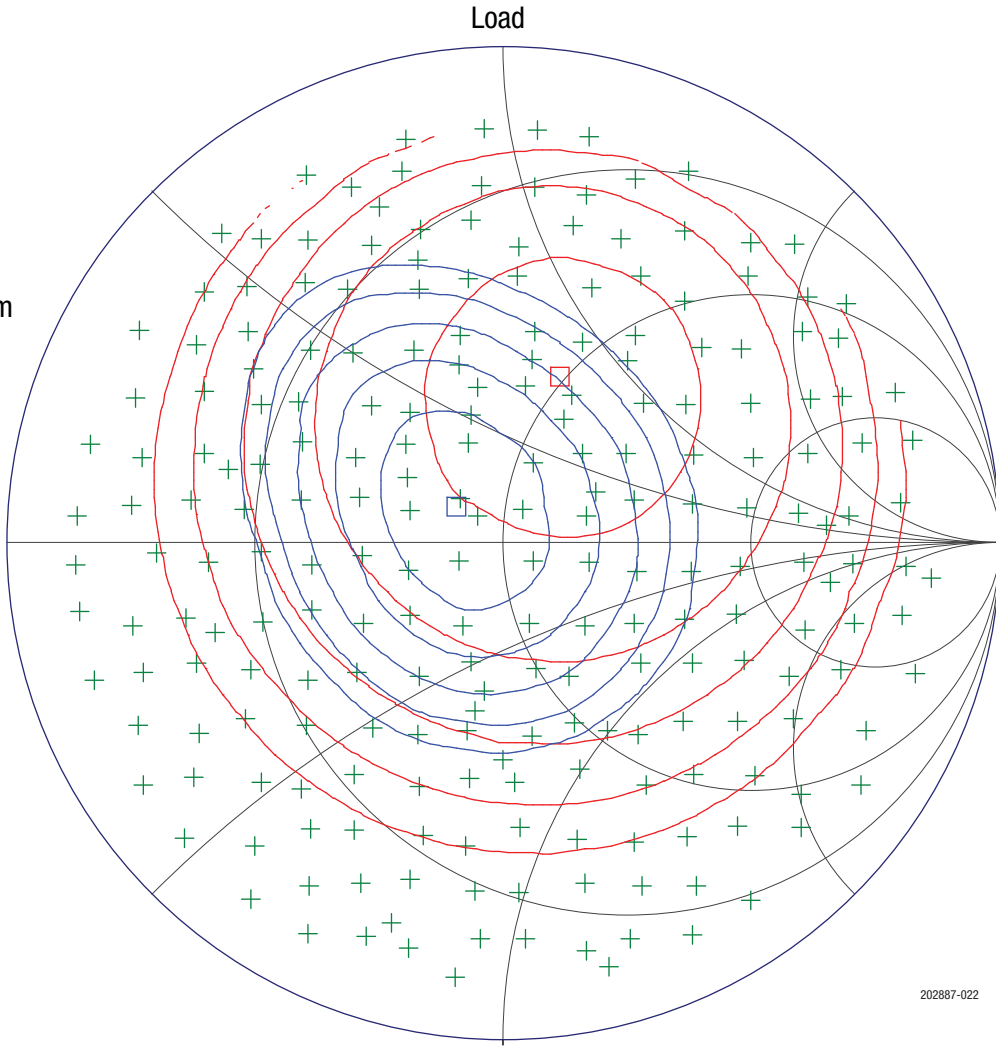

202887-022

Figure 22. OIP3 Load Pull @ 2600 MHz, 5 V, 70 mA (Input Load = Min NF, -20 dBm/tone, 5 MHz Spacing)

Evaluation Board Description

The SKY67153-396LF Evaluation Board is used to test the performance of the SKY67153-396LF LNA. Four different boards are available for different frequency operations: 700 to 1000 MHz, 1600 to 2170 MHz, 2300 to 2700 MHz, and 3400 to 3800 MHz.

An assembly drawing for the Evaluation Board is shown in Figure 23. The layer detail is provided in Figure 24. An Evaluation Board schematic diagram is provided in Figure 25 (500 to 3800 MHz). Tables 9 through 12 provide the Bill of Materials (BOM) list for the four different Evaluation Board tuning frequencies.

Package Dimensions

The PCB layout footprint for the SKY67153-396LF is provided in Figure 26. Typical part markings are shown in Figure 27. Package dimensions are shown in Figure 28, and tape and reel dimensions are provided in Figure 29.

Package and Handling Information

Instructions on the shipping container label regarding exposure to moisture after the container seal is broken must be followed. Otherwise, problems related to moisture absorption may occur when the part is subjected to high temperature during solder assembly.

The SKY67153-396LF is rated to Moisture Sensitivity Level 1 (MSL1) at 260 °C. It can be used for lead or lead-free soldering. For additional information, refer to the Skyworks Application Note, *Solder Reflow Information*, document number 200164.

Care must be taken when attaching this product, whether it is done manually or in a production solder reflow environment. Production quantities of this product are shipped in a standard tape and reel format.

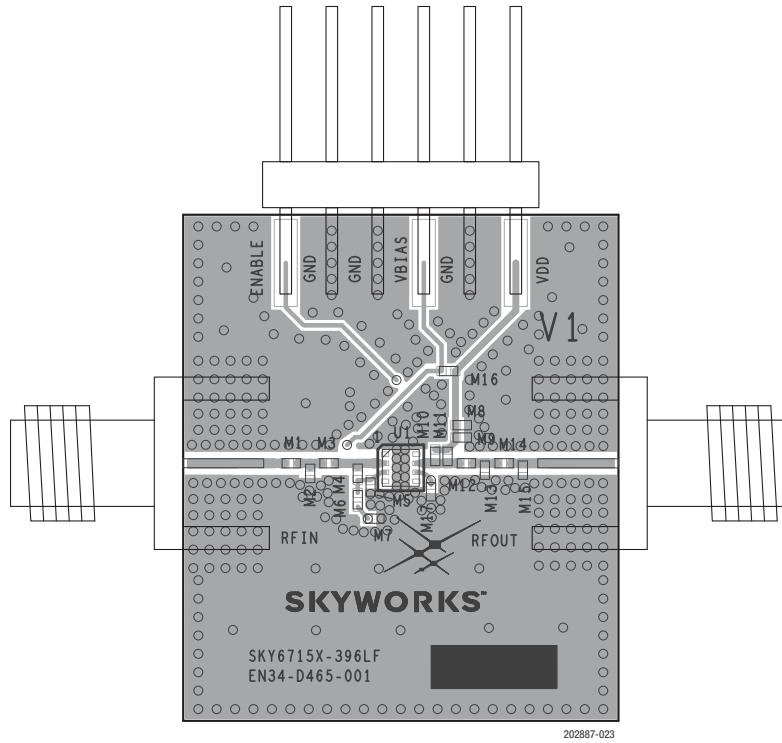

Figure 23. SKY67153-396LF Evaluation Board Assembly Diagram

| Cross Section | Name | Thickness (mm) | Material |
|---------------|-----------|----------------|----------------------|
| | MSK-NS | | |
| | TRA-NS | 0.03556 | Cu foil |
| | Laminated | 0.254 ± 0.152 | Rogers 4350B |
| | TRA-2 | 0.0178 | Cu foil |
| | Laminated | 0.889 nom. | FR4 Prepreg (Note 1) |
| | TRA-3 | 0.0178 | Cu foil |
| | Laminated | 0.254 ± 0.152 | FR4 Core |
| | TRA-FS | 0.0178 | Cu foil |
| | MSK-PS | | |

Note 1: Adjust this thickness to meet total thickness goal.

General Notes:

- Material: Rogers R04350, $\epsilon_r = 3.66$
- Layer 1 thickness: 0.254 mm
- Overall board thickness: 1.575 mm
- 50 Ω transmission line width: 0.522 mm
- Coplanar ground spacing: 0.394 mm
- Via diameter: 0.254 mm

202887-024

Figure 24. Layer Detail Physical Characteristics

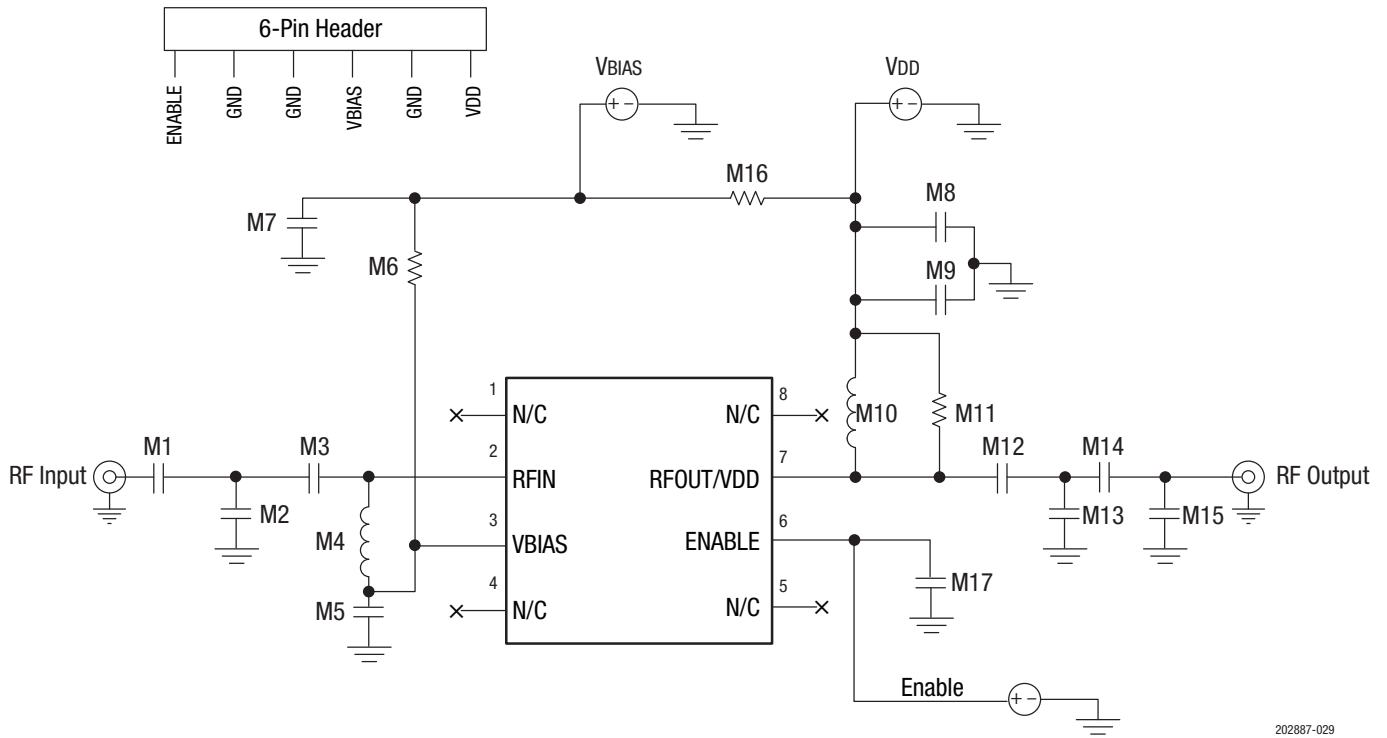

Figure 25. SKY67153-396LF Evaluation Board Schematic (700 to 3800 MHz)

202887-029

Table 9. SKY67153-396LF Evaluation Board Bill of Materials (700 to 1000 MHz Tuning)

| Component | Description | Value | Size | Manufacturer | Part Number |
|-----------|-------------|----------|------|--------------|-------------------|
| M1 | Inductor | 2.2 nH | 0402 | Coilcraft | 0402HP-2N2XJL |
| M2 | DNI | - | - | - | - |
| M3 | Capacitor | 20 pF | 0402 | Murata | GJM1555C1H200JB01 |
| M4 | Inductor | 15 nH | 0402 | Coilcraft | 0402HP-15NX_L |
| M5 | Capacitor | 68 pF | 0402 | Murata | GRM1555C1H680JZ01 |
| M6 | Resistor | 9.1 kΩ | 0402 | Kamaya | RMC1/16S-912JTH |
| M7, M8 | Capacitor | 10000 pF | 0402 | Murata | GRM155R71H103KA88 |
| M9, M12 | Capacitor | 100 pF | 0402 | Murata | GRM1555C1H101JZ01 |
| M10 | Inductor | 8.2 nH | 0402 | Murata | LQG15HS8N2J02 |
| M11 | Resistor | 330 Ω | 0402 | Kamaya | RMC1/16S-331JTH |
| M13 | Capacitor | 1.8 pF | 0402 | Murata | GJM1555C1H1R8CB01 |
| M14, M16 | Resistor | 0 Ω | 0402 | Kamaya | RMC1/16SJPTH |
| M15 | DNI | - | - | - | - |
| M17 | Capacitor | 1000 pF | 0402 | Murata | GRM1555C1H102JZ01 |

Table 10. SKY67153-396LF Evaluation Board Bill of Materials (1600 to 2170 MHz Tuning)

| Component | Description | Value | Size | Manufacturer | Part Number |
|-----------|-------------|---------------|------|--------------|-------------------|
| M1 | Capacitor | 20 pF | 0402 | Murata | GJM1555C1H200JB01 |
| M2 | Capacitor | 1 pF | 0402 | Murata | GJM1555C1H1R0CB01 |
| M3 | Inductor | 2 nH | 0402 | Coilcraft | 0402HP-2N0XJL |
| M4 | Inductor | 10 nH | 0402 | Coilcraft | 0402HP-10NX_L |
| M5 | Capacitor | 8.2 pF | 0402 | Murata | GJM1555C1H8R2DB01 |
| M6 | Resistor | 10 k Ω | 0402 | Kamaya | RMC1/16S-103JTH |
| M7 | Capacitor | 10000 pF | 0402 | Murata | GRM155R71H103KA88 |
| M8 | Capacitor | 1000 pF | 0402 | Murata | GRM155R71H102KA01 |
| M9 | Capacitor | 22 pF | 0402 | Murata | GRM1555C1H220JZ01 |
| M10 | Inductor | 3.6 nH | 0402 | Murata | LQG15HS3N6S02 |
| M11 | Resistor | 1 k Ω | 0402 | Kamaya | RMC1/16S-102JTH |
| M12 | Capacitor | 3.6 pF | 0402 | Murata | GJM1555C1H3R6CB01 |
| M13 | Resistor | 2 k Ω | 0402 | Kamaya | RMC1/16S-202JTH |
| M14, M16 | Resistor | 0 Ω | 0402 | Kamaya | RMC1/16SJPTH |
| M15 | DNI | – | – | – | – |
| M17 | Capacitor | 1000 pF | 0402 | Murata | GRM1555C1H102JZ01 |

Table 11. SKY67153-396LF Evaluation Board Bill of Materials (2300 to 2700 MHz Tuning)

| Component | Description | Value | Size | Manufacturer | Part Number |
|-----------|-------------|---------------|------|--------------|-------------------|
| M1 | Capacitor | 20 pF | 0402 | Murata | GJM1555C1H200JB01 |
| M2 | Capacitor | 1.2 pF | 0402 | Murata | GJM1555C1H1R2CB01 |
| M3 | Inductor | 1 nH | 0402 | Coilcraft | 0402HP-1N0XJL |
| M4 | Inductor | 12 nH | 0402 | Coilcraft | 0402HP-12NX_L |
| M5 | Capacitor | 56 pF | 0402 | Murata | GJM1555C1H560JZ01 |
| M6 | Resistor | 10 k Ω | 0402 | Kamaya | RMC1/16S-103JTH |
| M7 | Capacitor | 10000 pF | 0402 | Murata | GRM155R71H103KA88 |
| M8 | Capacitor | 1000 pF | 0402 | Murata | GRM155R71H102KA01 |
| M9 | Capacitor | 22 pF | 0402 | Murata | GRM1555C1H220JZ01 |
| M10 | Inductor | 2.7 nH | 0402 | Murata | LQG15HS2N7S02 |
| M11 | Resistor | 1 k Ω | 0402 | Kamaya | RMC1/16S-102JTH |
| M12 | Capacitor | 3.9 pF | 0402 | Murata | GJM1555C1H3R9CZ01 |
| M13 | Resistor | 2 k Ω | 0402 | Kamaya | RMC1/16S-202JTH |
| M14, M16 | Resistor | 0 Ω | 0402 | Kamaya | RMC1/16SJPTH |
| M15 | DNI | – | – | – | – |
| M17 | Capacitor | 1000 pF | 0402 | Murata | GRM1555C1H102JZ01 |

Table 12. SKY67153-396LF Evaluation Board Bill of Materials (3400 to 3800 MHz Tuning)

| Component | Description | Value | Size | Manufacturer | Part Number |
|-----------|-------------|----------|------|--------------|-------------------|
| M1 | Capacitor | 20 pF | 0402 | Murata | GJM1555C1H200JB01 |
| M2 | Capacitor | 1 pF | 0402 | Murata | GJM1555C1H1R0CB01 |
| M3 | Capacitor | 10 pF | 0402 | Murata | GJM1555C1H100JB01 |
| M4 | Inductor | 9 nH | 0402 | Coilcraft | 0402HP-9N0XJL |
| M5 | DNI | - | - | - | - |
| M6 | Resistor | 9.1 kΩ | 0402 | Kamaya | RMC1/16SK910FTH |
| M7 | Capacitor | 10000 pF | 0402 | Murata | GRM155R71H103KA88 |
| M8 | Capacitor | 1000 pF | 0402 | Murata | GRM155R71H102KA01 |
| M9 | Capacitor | 10 pF | 0402 | Murata | GJM1555C1H100JB01 |
| M10 | DNI | - | - | - | - |
| M11 | Inductor | 1 nH | 0402 | Murata | LQG15HS1N0S02 |
| M12 | Capacitor | 100 pF | 0402 | Murata | GRM1555C1H101JZ01 |
| M13 | Capacitor | 0.6 pF | 0402 | Murata | GJM1555C1HR60BB01 |
| M14, M16 | Resistor | 0 Ω | 0402 | Kamaya | RMC1/16SJPTH |
| M15 | DNI | - | - | - | - |
| M17 | Capacitor | 1000 pF | 0402 | Murata | GRM1555C1H102JZ01 |

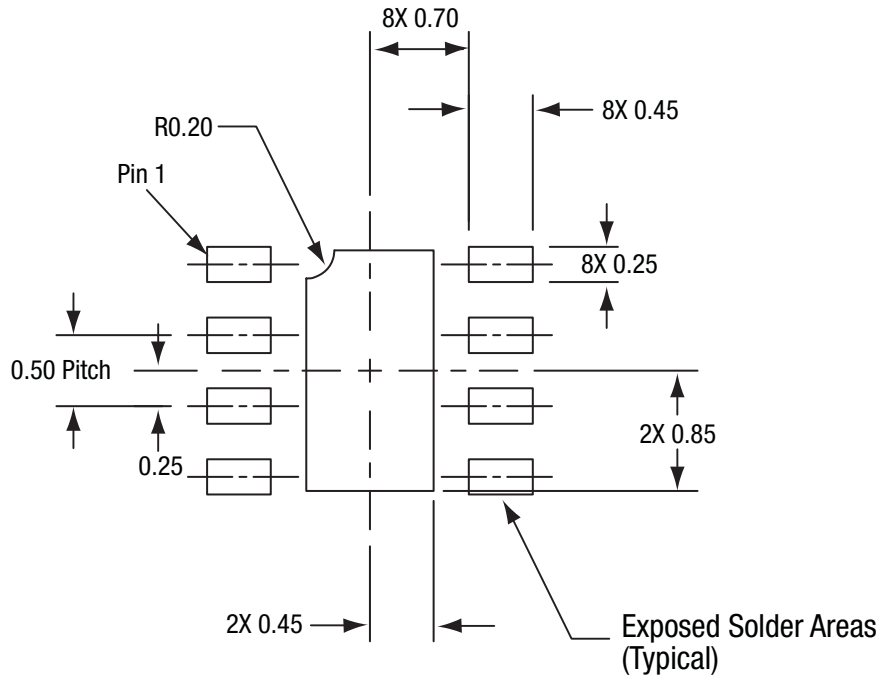

All dimensions are in millimeters

202887-026

Figure 26. SKY67153-396LF PCB Layout Footprint (Top View)

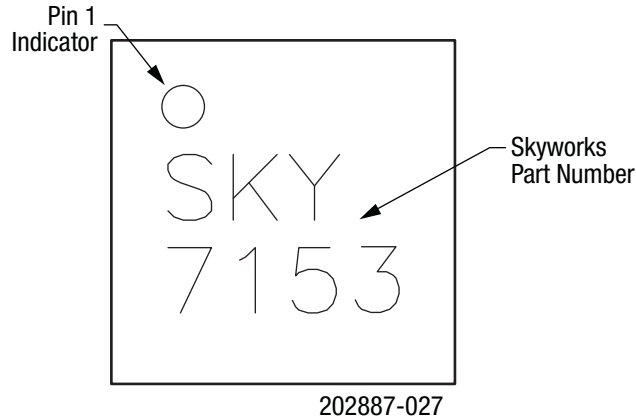
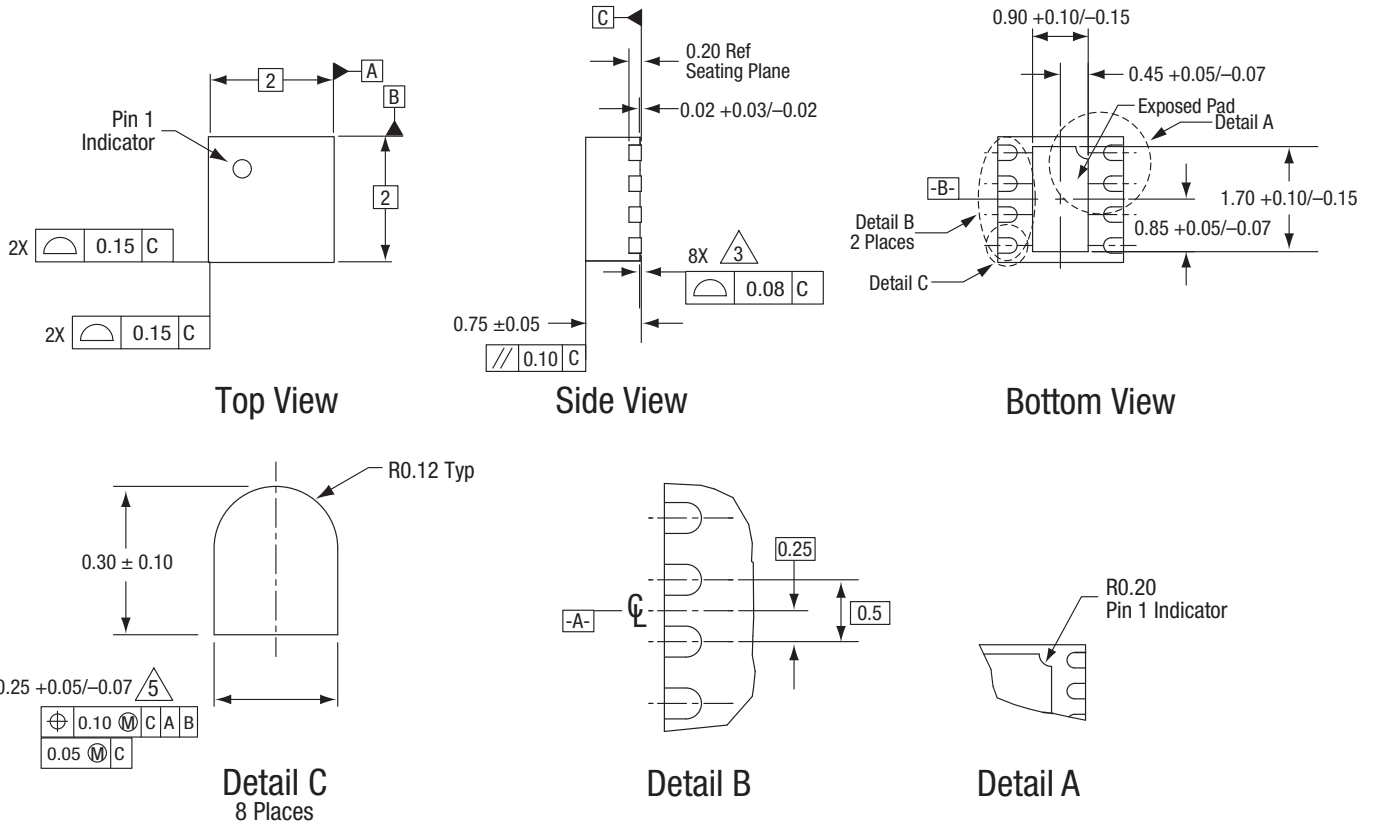

Figure 27. Typical Part Markings (Top View)



Notes:

1. All measurements are in millimeters.
2. Dimensions and tolerances according to ASME Y14.5M-1994.
3. Coplanarity applies to the exposed heat sink ground pad as well as the terminals.
4. Plating requirement per source control drawing (SCD) 2504.
5. Dimension applies to metallized terminal and is measured between 0.15 mm and 0.30 mm from terminal tip.

202887-028

Figure 28. SKY67153-396LF Package Dimensions

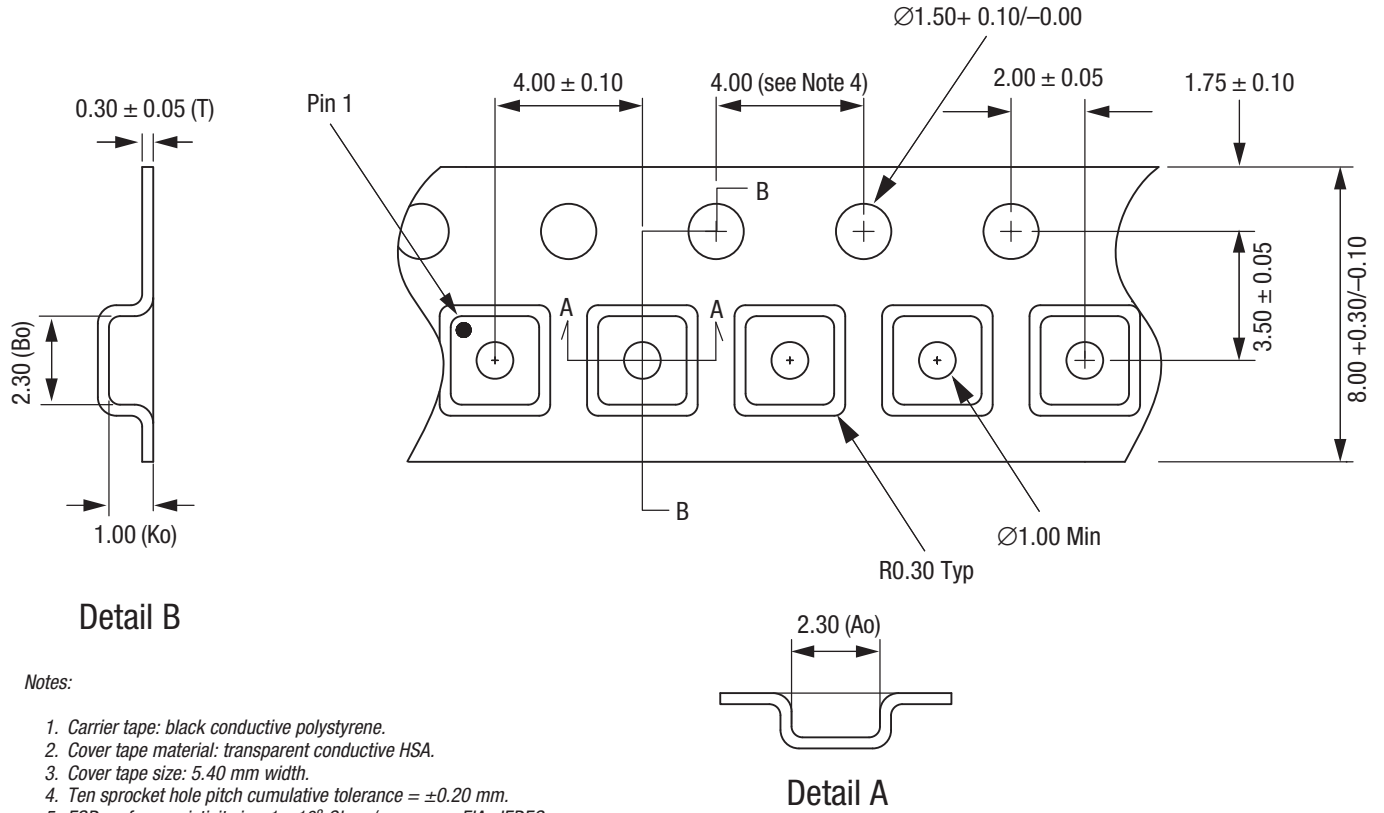

Detail B

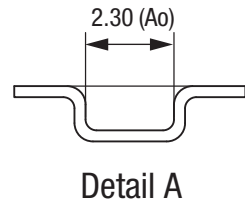

Notes:

1. Carrier tape: black conductive polystyrene.
2. Cover tape material: transparent conductive HSA.
3. Cover tape size: 5.40 mm width.
4. Ten sprocket hole pitch cumulative tolerance = ±0.20 mm.
5. ESD surface resistivity is $\leq 1 \times 10^8$ Ohms/square per EIA, JEDEC tape and reel specification.
6. Ao and Bo measurement point to be 0.30 mm from bottom pocket.
7. All measurements are in millimeters.

202887-029

Figure 29. SKY67153-396LF Tape and Reel Dimensions

Ordering Information

| Model Name | Manufacturing Part Number | Evaluation Board Part Number |
|--------------------|---------------------------|---|
| SKY67153-396LF LNA | SKY67153-396LF | SKY67153-396EK1 (700-1000 MHz) SKY67153-396EK2 (1600-2170 MHz) SKY67153-396EK3 (2300-2700 MHz) SKY67153-396EK4 (3400-3800 MHz) |

Copyright © 2013-2014, 2016-2017 Skyworks Solutions, Inc. All Rights Reserved.

Information in this document is provided in connection with Skyworks Solutions, Inc. ("Skyworks") products or services. These materials, including the information contained herein, are provided by Skyworks as a service to its customers and may be used for informational purposes only by the customer. Skyworks assumes no responsibility for errors or omissions in these materials or the information contained herein. Skyworks may change its documentation, products, services, specifications or product descriptions at any time, without notice. Skyworks makes no commitment to update the materials or information and shall have no responsibility whatsoever for conflicts, incompatibilities, or other difficulties arising from any future changes.

No license, whether express, implied, by estoppel or otherwise, is granted to any intellectual property rights by this document. Skyworks assumes no liability for any materials, products or information provided hereunder, including the sale, distribution, reproduction or use of Skyworks products, information or materials, except as may be provided in Skyworks Terms and Conditions of Sale.

THE MATERIALS, PRODUCTS AND INFORMATION ARE PROVIDED "AS IS" WITHOUT WARRANTY OF ANY KIND, WHETHER EXPRESS, IMPLIED, STATUTORY, OR OTHERWISE, INCLUDING FITNESS FOR A PARTICULAR PURPOSE OR USE, MERCHANTABILITY, PERFORMANCE, QUALITY OR NON-INFRINGEMENT OF ANY INTELLECTUAL PROPERTY RIGHT; ALL SUCH WARRANTIES ARE HEREBY EXPRESSLY DISCLAIMED. SKYWORKS DOES NOT WARRANT THE ACCURACY OR COMPLETENESS OF THE INFORMATION, TEXT, GRAPHICS OR OTHER ITEMS CONTAINED WITHIN THESE MATERIALS. SKYWORKS SHALL NOT BE LIABLE FOR ANY DAMAGES, INCLUDING BUT NOT LIMITED TO ANY SPECIAL, INDIRECT, INCIDENTAL, STATUTORY, OR CONSEQUENTIAL DAMAGES, INCLUDING WITHOUT LIMITATION, LOST REVENUES OR LOST PROFITS THAT MAY RESULT FROM THE USE OF THE MATERIALS OR INFORMATION, WHETHER OR NOT THE RECIPIENT OF MATERIALS HAS BEEN ADVISED OF THE POSSIBILITY OF SUCH DAMAGE.

Skyworks products are not intended for use in medical, lifesaving or life-sustaining applications, or other equipment in which the failure of the Skyworks products could lead to personal injury, death, physical or environmental damage. Skyworks customers using or selling Skyworks products for use in such applications do so at their own risk and agree to fully indemnify Skyworks for any damages resulting from such improper use or sale.

Customers are responsible for their products and applications using Skyworks products, which may deviate from published specifications as a result of design defects, errors, or operation of products outside of published parameters or design specifications. Customers should include design and operating safeguards to minimize these and other risks. Skyworks assumes no liability for applications assistance, customer product design, or damage to any equipment resulting from the use of Skyworks products outside of stated published specifications or parameters.

Skyworks and the Skyworks symbol are trademarks or registered trademarks of Skyworks Solutions, Inc., in the United States and other countries. Third-party brands and names are for identification purposes only, and are the property of their respective owners. Additional information, including relevant terms and conditions, posted at www.skyworksinc.com, are incorporated by reference.

X-ON Electronics

Largest Supplier of Electrical and Electronic Components

Click to view similar products for [RF Development Tools](#) category:

Click to view products by [Skyworks](#) manufacturer:

Other Similar products are found below :

[MAAM-011117](#) [MAAP-015036-DIEEV2](#) [EV1HMC1113LP5](#) [EV1HMC6146BLC5A](#) [EV1HMC637ALP5](#) [EVAL-ADG919EBZ](#) [ADL5363-EVALZ](#) [LMV228SDEVAL](#) [SKYA21001-EVB](#) [SMP1331-085-EVB](#) [EV1HMC618ALP3](#) [EVAL01-HMC1041LC4](#) [MAAL-011111-000SMB](#) [MAAM-009633-001SMB](#) [MASW-000936-001SMB](#) [107712-HMC369LP3](#) [107780-HMC322ALP4](#) [SP000416870](#) [EV1HMC470ALP3](#) [EV1HMC520ALC4](#) [EV1HMC244AG16](#) [MAX2614EVKIT#](#) [124694-HMC742ALP5](#) [SC20ASATEA-8GB-STD](#) [MAX2837EVKIT+](#) [MAX2612EVKIT#](#) [MAX2692EVKIT#](#) [EV1HMC629ALP4E](#) [SKY12343-364LF-EVB](#) [108703-HMC452QS16G](#) [EV1HMC863ALC4](#) [119197-HMC658LP2](#) [EV1HMC647ALP6](#) [ADL5725-EVALZ](#) [106815-HMC441LM1](#) [EV1HMC1018ALP4](#) [UXN14M9PE](#) [MAX2016EVKIT](#) [EV1HMC939ALP4](#) [MAX2410EVKIT](#) [MAX2204EVKIT+](#) [EV1HMC8073LP3D](#) [SIMSA868-DKL](#) [SIMSA868C-DKL](#) [SKY65806-636EK1](#) [SKY68020-11EK1](#) [SKY67159-396EK1](#) [SKY66181-11-EK1](#) [SKY65804-696EK1](#) [SKY13396-397LF-EVB](#)