

DATA SHEET

# SMP1352 Series: Large Signal Switching, Plastic Packaged PIN Diodes

## Applications

- Large signal switches in base stations and handsets

## Features

- Packages rated MSL1, 260 °C per JEDEC J-STD-020



Skyworks Green™ products are compliant with all applicable legislation and are halogen-free. For additional information, refer to *Skyworks Definition of Green™*, document number SQ04-0074.



## Description

The SMP1352 series of plastic packaged, surface mountable low capacitance (0.3 pF) silicon PIN diodes is designed for large signal switch applications from 10 MHz to more than 10 GHz. These diodes have a reverse voltage rating of 200 V and are designed for use in low-distortion switches that are required to hold off large RF voltages.

The nominal 50  $\mu\text{m}$  I-region width, combined with the typical 1.5  $\mu\text{s}$  carrier lifetime, results in a PIN diode with low forward resistance and low distortion characteristics.

Table 1 describes the various packages and marking of the SMP1352 series.

**Table 1. SMP1352 Series Packaging and Marking**

Single	Single	Series Pair	Single
SC-79 Green™	SOD-323 Green™	SOT-23 Green™	SOD-882 Green™
◆ SMP1352-079LF Marking: Cathode	SMP1352-011LF Marking: RR	SMP1352-005LF Marking: RR2	SMP1352-040LF Marking: S
$L_S = 0.7 \text{ nH}$	$L_S = 1.5 \text{ nH}$	$L_S = 1.5 \text{ nH}$	$L_S = 0.45 \text{ nH}$



The Pb-free symbol or "LF" in the part number denotes a lead-free, RoHS-compliant package unless otherwise noted as Green™. Tin/lead (Sn/Pb) packaging is not recommended for new designs.

**Table 2. SMP1352 Series Absolute Maximum Ratings (Note 1)**

Parameter	Symbol	Minimum	Maximum	Units
Reverse voltage	$V_R$		200	V
Power dissipation @ 25 °C lead temperature	$P_D$		250	mW
Storage temperature	$T_{STG}$	-65	+150	°C
Operating temperature	$T_A$	-65	+150	°C
Electrostatic discharge: Human Body Model (HBM), Class 1C	ESD		1000	V

**Note 1:** Exposure to maximum rating conditions for extended periods may reduce device reliability. There is no damage to device with only one parameter set at the limit and all other parameters set at or below their nominal value. Exceeding any of the limits listed here may result in permanent damage to the device.

**CAUTION:** Although this device is designed to be as robust as possible, electrostatic discharge (ESD) can damage this device. This device must be protected at all times from ESD. Static charges may easily produce potentials of several kilovolts on the human body or equipment, which can discharge without detection. Industry-standard ESD precautions should be used at all times.

**Table 3. SMP1352 Series Electrical Specifications (Note 1)**

( $T_A = +25 \text{ °C}$ , Unless Otherwise Noted)

Parameter	Symbol	Test Condition	Min	Typical	Max	Units
Reverse current	$I_R$	$V_R = 200 \text{ V}$			10	$\mu\text{A}$
Capacitance	$C_T$	$F = 1 \text{ MHz}, V = 20 \text{ V}$			0.35	pF
Resistance	$R_S$	$F = 100 \text{ MHz}$ $I = 1 \text{ mA}$ $I = 10 \text{ mA}$ $I = 100 \text{ mA}$		11 2 1	15 2.80 1.35	$\Omega$ $\Omega$ $\Omega$
Forward voltage	$V_F$	$I_F = 10 \text{ mA}$		0.8		V
Carrier lifetime	$\tau_I$	$I_F = 10 \text{ mA}$		1		$\mu\text{s}$
I region width				50		$\mu\text{m}$

**Note 1:** Performance is guaranteed only under the conditions listed in this table.

## Electrical and Mechanical Specifications

The absolute maximum ratings of the SMP1352 series are provided in Table 2. Electrical specifications are provided in Table 3. Resistance versus temperature measurements are provided in Table 4.

Typical performance characteristics of the SMP1352 series are illustrated in Figures 1 to 4. Package dimensions are shown in Figures 5 to 11 (odd numbers), and tape and reel dimensions are provided in Figures 6 to 12 (even numbers).

## Package and Handling Information

Instructions on the shipping container label regarding exposure to moisture after the container seal is broken must be followed.

Otherwise, problems related to moisture absorption may occur when the part is subjected to high temperature during solder assembly.

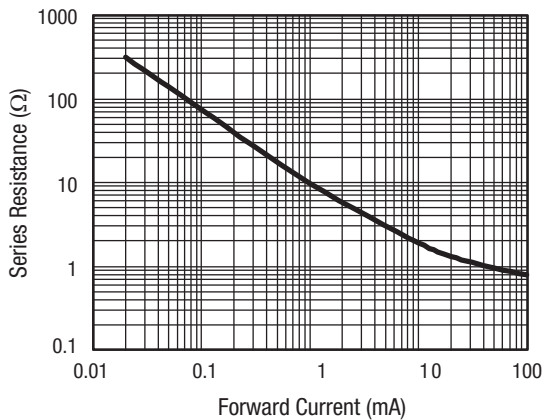
The SMP1352 series is rated to Moisture Sensitivity Level 1 (MSL1) at 260 °C. It can be used for lead or lead-free soldering. For additional information, refer to the Skyworks Application Note, *Solder Reflow Information*, document number 200164.

Care must be taken when attaching this product, whether it is done manually or in a production solder reflow environment. Production quantities of this product are shipped in a standard tape and reel format.

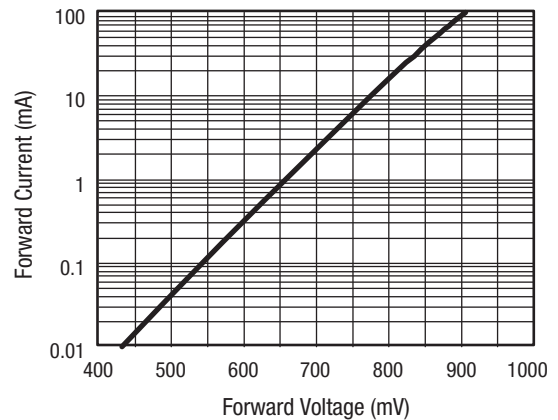
**Table 4. Resistance vs Temperature @ 100 MHz**

I <sub>F</sub> (mA)	R <sub>S</sub> @ -55 °C (Ω)	R <sub>S</sub> @ -15 °C (Ω)	R <sub>S</sub> @ +25 °C (Ω)	R <sub>S</sub> @ +65 °C (Ω)	R <sub>S</sub> @ +100 °C (Ω)
0.02	260	276	302	263	240
0.10	60.9	64.0	70.6	71.0	70.1
0.30	22.4	23.6	26.0	27.8	28.2
1.0	7.9	8.5	9.2	10.3	10.7
10	1.5	1.7	1.9	2.2	2.3
20	1.1	1.2	1.3	1.6	1.7
100	0.55	0.69	0.78	0.98	1.03

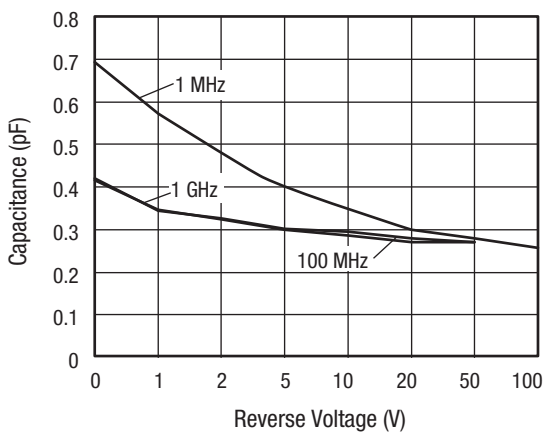
## Typical Performance Characteristics



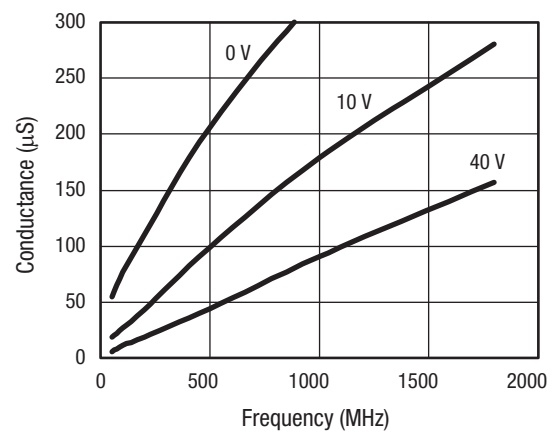
**Figure 1. Series Resistance vs Current @ 100 MHz**



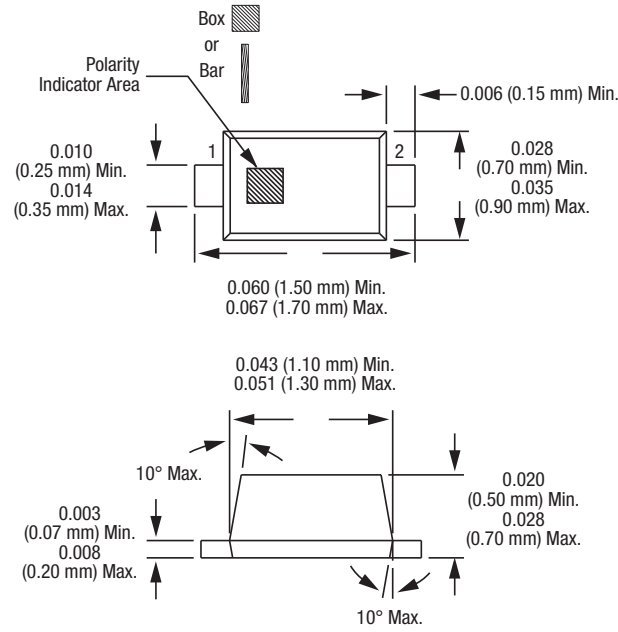
**Figure 2. DC Characteristics**



**Figure 3. Capacitance vs Reverse Voltage**

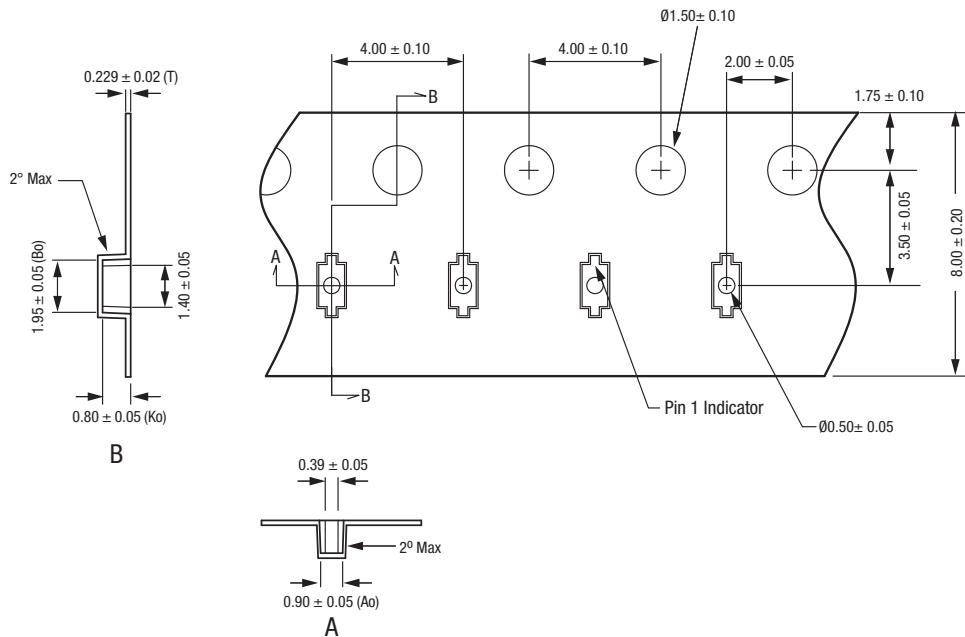


**Figure 4. Conductance vs Frequency and Reverse Voltage**



Dimensions are in inches (millimeters shown in parentheses) S1652

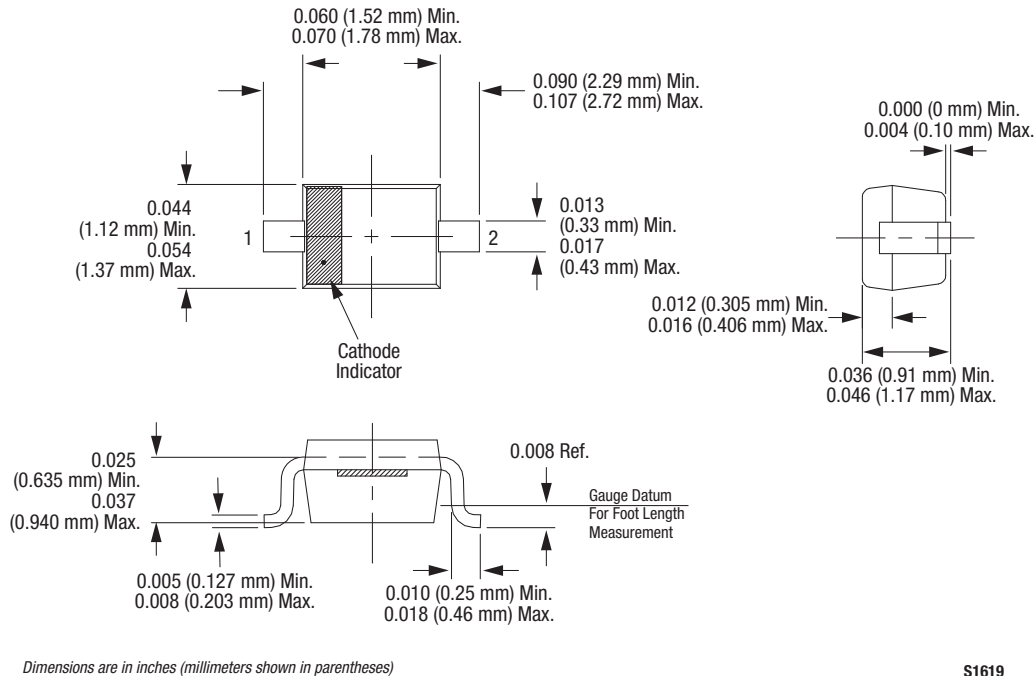
Figure 5. SC-79 Package Dimension Drawing



- Notes:
1. Carrier tape: black conductive polycarbonate or polystyrene.
  2. Cover tape material: transparent conductive PSA.
  3. Cover tape size: 5.4 mm width.
  4. ESD-surface resistivity is  $\leq 1 \times 10^8$  Ohms/square per EIA, JEDEC TNR Specification.
  4. All measurements are in millimeters.

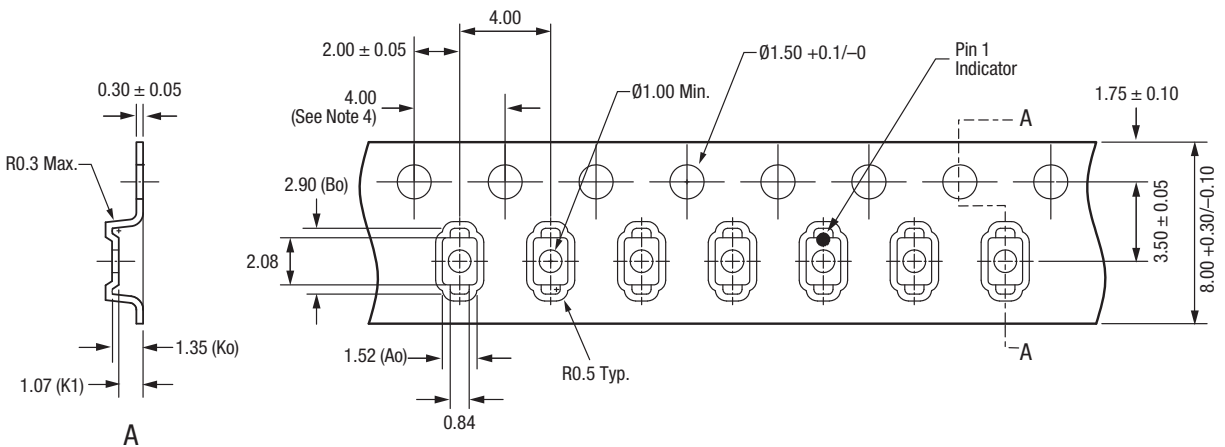
S2929

Figure 6. SC-79 Tape and Reel Dimensions



S1619

Figure 7. SOD-323 Package Dimension Drawing

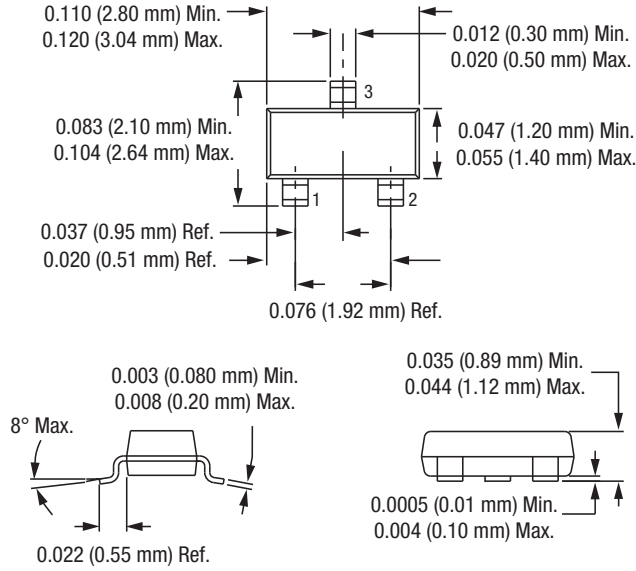


Notes:

1. Carrier tape: black conductive polystyrene.
2. Cover tape: transparent conductive PSA.
3. Cover tape size: 5.4 mm width.
4. 10 sprocket hole pitch cumulative tolerance: ±0.20 mm.
5. All measurements are in millimeters.

S2910

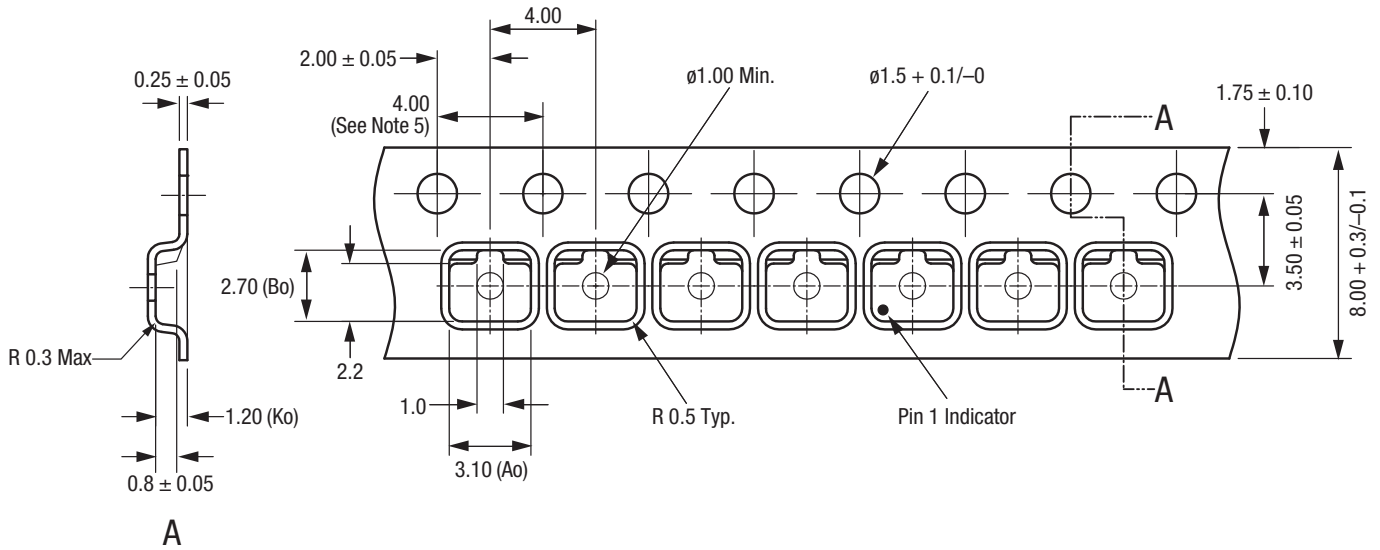
Figure 8. SOD-323 Tape and Reel Dimensions



Dimensions are in inches (millimeters shown in parentheses)

S1389

Figure 9. SOT-23 Package Dimension Drawing

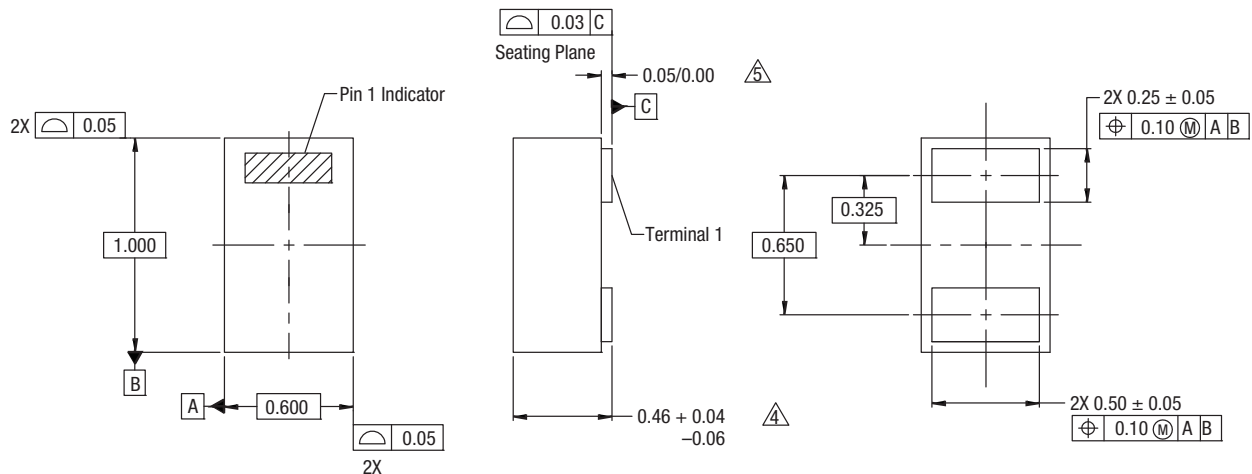


Notes:

1. Carrier tape: black conductive polycarbonate.
2. Cover tape material: transparent conductive PSA.
3. Cover tape size: 5.40 mm width.
4. Tolerance ±0.10 mm.
5. Ten sprocket hole pitch cumulative tolerance: ±0.2 mm.
6. All measurements are in millimeters.
7. Alternative carrier tape dimensions are:  
 $A_o = 3.3$   
 $B_o = 2.9$   
 $K_o = 1.22$

S1684b

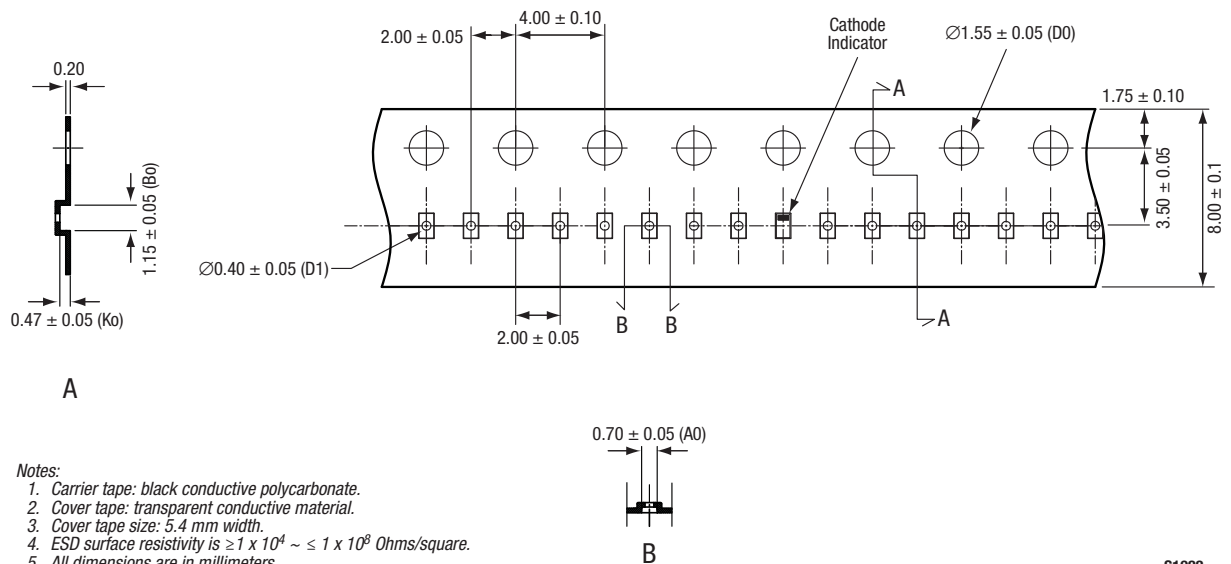
Figure 10. SOT-23 Tape and Reel Dimensions



- NOTES:
1. All measurements are in millimeters.
  2. Dimensions and tolerances according to ASME Y14.5M-1994.
  3. These packages are used principally for discrete devices.
  4. This dimension includes stand-off height and package body thickness, but does not include attached features, e.g., external heatsink or chip capacitors. An integral heatslug is not considered an attached feature.
  5. This dimension is primarily terminal plating, but does not include small metal protrusion.

Y1410

Figure 11. SOD-882 Package Dimension Drawing



- Notes:
1. Carrier tape: black conductive polycarbonate.
  2. Cover tape: transparent conductive material.
  3. Cover tape size: 5.4 mm width.
  4. ESD surface resistivity is  $\geq 1 \times 10^4 \sim \leq 1 \times 10^8$  Ohms/square.
  5. All dimensions are in millimeters.

S1922

Figure 12. SOD-882 Tape and Reel Dimensions



Copyright © 2002-2012, 2014-2015 Skyworks Solutions, Inc. All Rights Reserved.

Information in this document is provided in connection with Skyworks Solutions, Inc. ("Skyworks") products or services. These materials, including the information contained herein, are provided by Skyworks as a service to its customers and may be used for informational purposes only by the customer. Skyworks assumes no responsibility for errors or omissions in these materials or the information contained herein. Skyworks may change its documentation, products, services, specifications or product descriptions at any time, without notice. Skyworks makes no commitment to update the materials or information and shall have no responsibility whatsoever for conflicts, incompatibilities, or other difficulties arising from any future changes.

No license, whether express, implied, by estoppel or otherwise, is granted to any intellectual property rights by this document. Skyworks assumes no liability for any materials, products or information provided hereunder, including the sale, distribution, reproduction or use of Skyworks products, information or materials, except as may be provided in Skyworks Terms and Conditions of Sale.

THE MATERIALS, PRODUCTS AND INFORMATION ARE PROVIDED "AS IS" WITHOUT WARRANTY OF ANY KIND, WHETHER EXPRESS, IMPLIED, STATUTORY, OR OTHERWISE, INCLUDING FITNESS FOR A PARTICULAR PURPOSE OR USE, MERCHANTABILITY, PERFORMANCE, QUALITY OR NON-INFRINGEMENT OF ANY INTELLECTUAL PROPERTY RIGHT; ALL SUCH WARRANTIES ARE HEREBY EXPRESSLY DISCLAIMED. SKYWORKS DOES NOT WARRANT THE ACCURACY OR COMPLETENESS OF THE INFORMATION, TEXT, GRAPHICS OR OTHER ITEMS CONTAINED WITHIN THESE MATERIALS. SKYWORKS SHALL NOT BE LIABLE FOR ANY DAMAGES, INCLUDING BUT NOT LIMITED TO ANY SPECIAL, INDIRECT, INCIDENTAL, STATUTORY, OR CONSEQUENTIAL DAMAGES, INCLUDING WITHOUT LIMITATION, LOST REVENUES OR LOST PROFITS THAT MAY RESULT FROM THE USE OF THE MATERIALS OR INFORMATION, WHETHER OR NOT THE RECIPIENT OF MATERIALS HAS BEEN ADVISED OF THE POSSIBILITY OF SUCH DAMAGE.

Skyworks products are not intended for use in medical, lifesaving or life-sustaining applications, or other equipment in which the failure of the Skyworks products could lead to personal injury, death, physical or environmental damage. Skyworks customers using or selling Skyworks products for use in such applications do so at their own risk and agree to fully indemnify Skyworks for any damages resulting from such improper use or sale.

Customers are responsible for their products and applications using Skyworks products, which may deviate from published specifications as a result of design defects, errors, or operation of products outside of published parameters or design specifications. Customers should include design and operating safeguards to minimize these and other risks. Skyworks assumes no liability for applications assistance, customer product design, or damage to any equipment resulting from the use of Skyworks products outside of stated published specifications or parameters.

Skyworks and the Skyworks symbol are trademarks or registered trademarks of Skyworks Solutions, Inc., in the United States and other countries. Third-party brands and names are for identification purposes only, and are the property of their respective owners. Additional information, including relevant terms and conditions, posted at [www.skyworksinc.com](http://www.skyworksinc.com), are incorporated by reference.

## X-ON Electronics

Largest Supplier of Electrical and Electronic Components

*Click to view similar products for [PIN Diodes](#) category:*

*Click to view products by [Skyworks](#) manufacturer:*

Other Similar products are found below :

[MA45471](#) [MA4SPS502](#) [APD2220-000](#) [APD0810-000](#) [MA4FCP200](#) [MA4GP907](#) [MA4L032-186](#) [MA4L401-30](#) [MA4P606-258](#)  
[MA4P7435NM-1091T](#) [MA4PK2000](#) [MA4PK2001](#) [MA4PK2004](#) [MADP-007167-12250T](#) [MADP-030025-13140P](#) [BAR 64-02V H6327](#)  
[MA4PBL027](#) [MA4AGFCP910](#) [MA4P7101F-1072T](#) [MA4L022-30](#) [MA47047-54](#) [BAR 89-02LRH E6327](#) [UM7108B](#) [UM9701](#) [1SV308,L3F](#)  
[UM9301SM](#) [GC4723-42](#) [MA4L011-1088](#) [MSW2001-200](#) [SMP1321-000](#) [UM4010SM](#) [UM6002B](#) [UM7006A](#) [UM7006B](#) [UM7108C](#)  
[GC4742-42](#) [MADP-000015-000030](#) [MGPN1503-C01A](#) [LXP1002-23-2](#) [UMX512](#) [LXP1000-23-2](#) [LXP1004-23-2](#) [LXP1002-23-0](#) [LXP1004-23-0](#) [MPP4202-206](#) [MPP4205-206](#) [SMP1321-011LF](#) [MA4L021-1056](#) [MSW2031-203](#) [MLP7120-11](#)