

ST 2SD1664U

NPN SILICON EPITAXIAL MEDIUM POWER TRANSISTOR

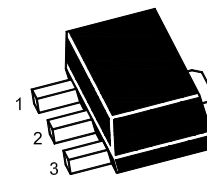

1.Base 2.Collector 3.Emitter
SOT-89 Plastic Package

Absolute Maximum Ratings ($T_a = 25^\circ\text{C}$)

Parameter	Symbol	Value	Unit
Collector Base Voltage	V_{CBO}	40	V
Collector Emitter Voltage	V_{CEO}	32	V
Emitter Base Voltage	V_{EBO}	5	V
Collector Current - DC	I_C	1	A
Collector Current - Pulse ¹⁾	I_{CP}	2	A
Total Power Dissipation	P_{tot}	0.5 2 ²⁾	W
Junction Temperature	T_J	150	$^\circ\text{C}$
Storage Temperature Range	T_{Stg}	- 55 to + 150	$^\circ\text{C}$

¹⁾ Single pulse, PW = 100 ms.

²⁾ When mounted on a 40 X 40 X 0.7 mm ceramic board.

Characteristics at $T_a = 25^\circ\text{C}$

Parameter	Symbol	Min.	Typ.	Max.	Unit	
DC Current Gain at $V_{CE} = 3\text{ V}$, $I_C = 100\text{ mA}$ Current Gain Group	P	h_{FE}	82	-	180	-
	Q	h_{FE}	120	-	270	-
	R	h_{FE}	180	-	390	-
Collector Base Breakdown Voltage at $I_C = 50\text{ }\mu\text{A}$	$V_{(BR)CBO}$	40	-	-	V	
Collector Emitter Breakdown Voltage at $I_C = 1\text{ mA}$	$V_{(BR)CEO}$	32	-	-	V	
Emitter Base Breakdown Voltage at $I_E = 50\text{ }\mu\text{A}$	$V_{(BR)EBO}$	5	-	-	V	
Collector Cutoff Current at $V_{CB} = 20\text{ V}$	I_{CBO}	-	-	0.5	μA	
Emitter Cutoff Current at $V_{EB} = 4\text{ V}$	I_{EBO}	-	-	0.5	μA	
Collector Emitter Saturation Voltage at $I_C = 500\text{ mA}$, $I_B = 50\text{ mA}$	$V_{CE(sat)}$	-	-	0.4	V	
Transition Frequency at $-I_E = 50\text{ mA}$, $V_{CE} = 5\text{ V}$, $f = 100\text{ MHz}$	f_T	-	150	-	MHz	
Output Capacitance at $V_{CB} = 10\text{ V}$, $f = 1\text{ MHz}$	C_{ob}	-	15	-	pF	

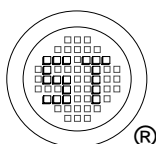

SEMTECH ELECTRONICS LTD.
Subsidiary of Sino-Tech International (BVI) Limited



Dated: 07/11/2013 Rev: 01

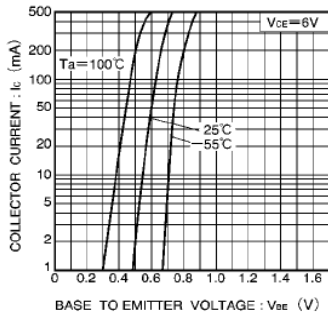

Fig.1 Grounded emitter propagation characteristics

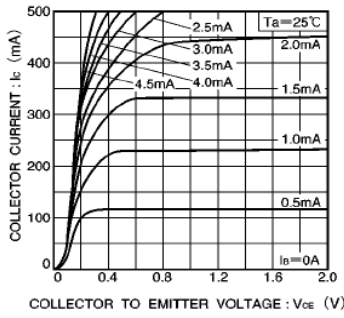

Fig.2 Grounded emitter output characteristics

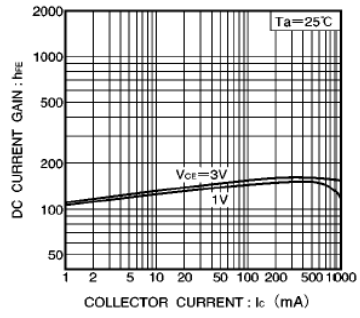

Fig.3 DC current gain vs. collector current (I)

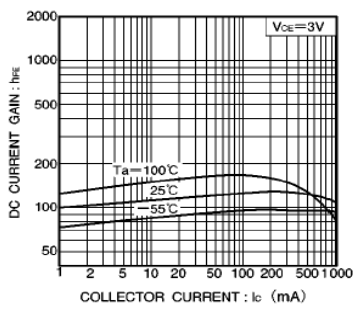

Fig.4 DC current gain vs. collector current (II)

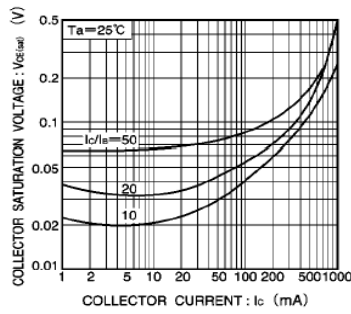

Fig.5 Collector-emitter saturation voltage vs. collector current (I)

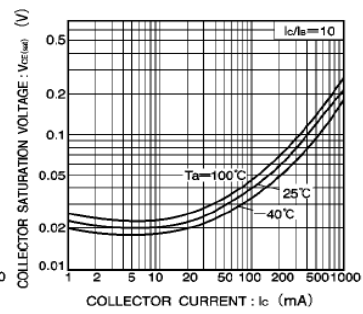

Fig.6 Collector-emitter saturation voltage vs. collector current (II)

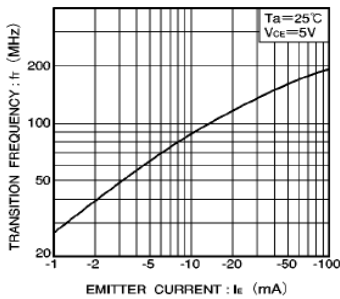

Fig.7 Gain bandwidth product vs. emitter current

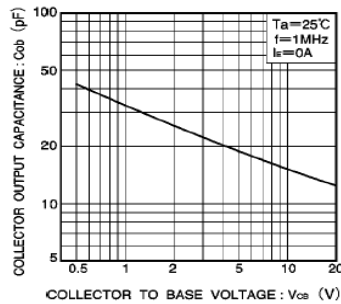

Fig.8 Collector output capacitance vs. collector-base voltage

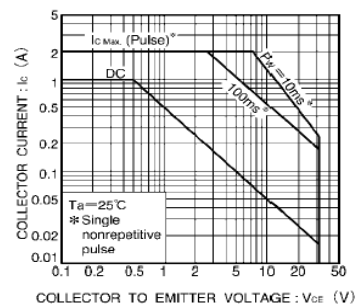

Fig.9 Safe operating area (2SD1664)

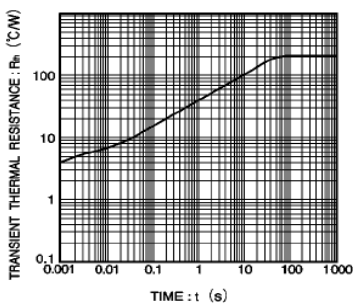
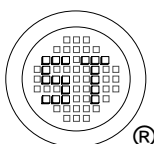

Fig.10 Transient thermal resistance (2SD1664)



SEMTECH ELECTRONICS LTD.
Subsidiary of Sino-Tech International (BVI) Limited



ST 2SD1664U

SOT-89 PACKAGE OUTLINE

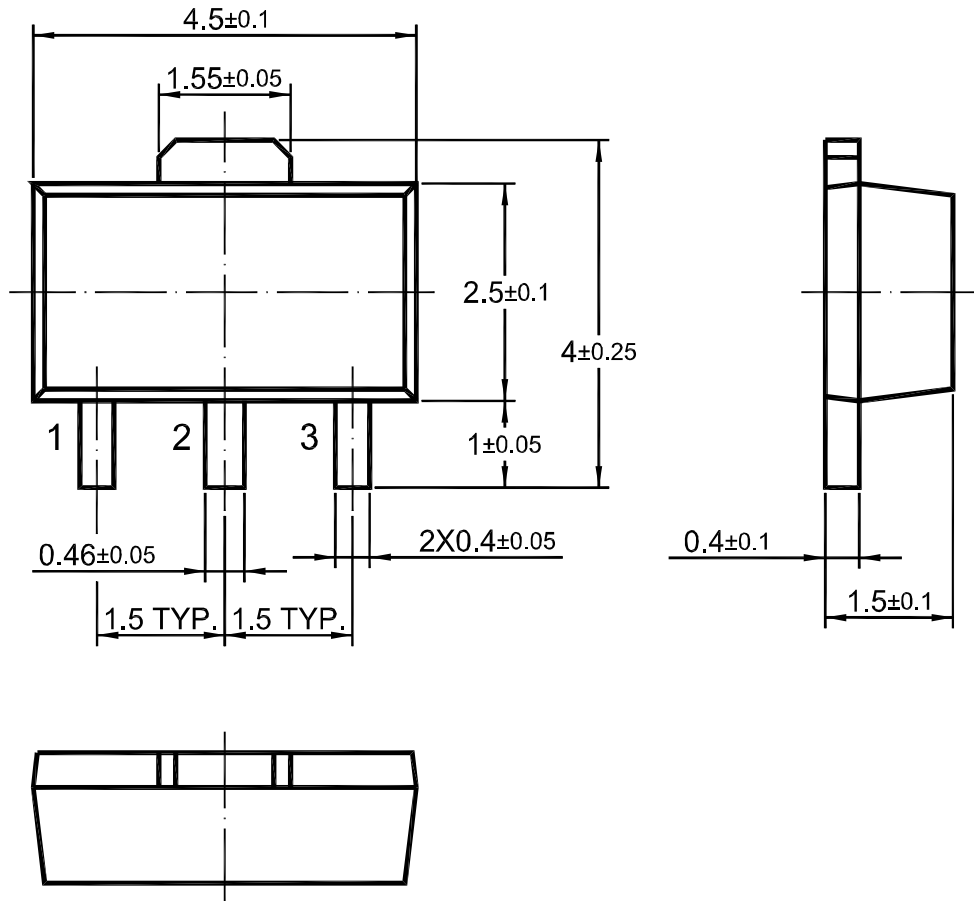

Dimensions in mm

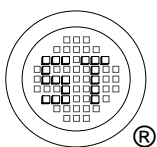

SEMTECH ELECTRONICS LTD.
Subsidiary of Sino-Tech International (BVI) Limited



Dated: 07/11/2013 Rev: 01

X-ON Electronics

Largest Supplier of Electrical and Electronic Components

Click to view similar products for [Bipolar Transistors - BJT category](#):

Click to view products by [SLKORMICRO manufacturer](#):

Other Similar products are found below :

[619691C](#) [MCH4017-TL-H](#) [MJ15024/WS](#) [MJ15025/WS](#) [BC546/116](#) [BC556/FSC](#) [BC557/116](#) [BSW67A](#) [HN7G01FU-A\(T5L,F,T](#)
[NJVMJD148T4G](#) [NSVMMBT6520LT1G](#) [NTE187A](#) [NTE195A](#) [NTE2302](#) [NTE2330](#) [NTE2353](#) [NTE316](#) [IMX9T110](#) [NTE63](#) [NTE65](#)
[C4460](#) [SBC846BLT3G](#) [2SA1419T-TD-H](#) [2SA1721-O\(TE85L,F\)](#) [2SA1727TLP](#) [2SA2126-E](#) [2SB1202T-TL-E](#) [2SB1204S-TL-E](#) [2SC5488A-](#)
[TL-H](#) [2SD2150T100R](#) [SP000011176](#) [FMC5AT148](#) [2N2369ADCSM](#) [2SB1202S-TL-E](#) [2SC2412KT146S](#) [2SC4618TLN](#) [2SC5490A-TL-H](#)
[2SD1816S-TL-E](#) [2SD1816T-TL-E](#) [CMXT2207 TR](#) [CPH6501-TL-E](#) [MCH4021-TL-E](#) [BC557B](#) [TTC012\(Q\)](#) [BULD128DT4](#) [JANTX2N3810](#)
[Jantx2N5416](#) [US6T6TR](#) [KSF350](#) [068071B](#)