

■ Schottky Diodes

■ Features

- High Breakdown Voltage
- Low Turn-on Voltage
- Guard Ring Construction for Transient Protection

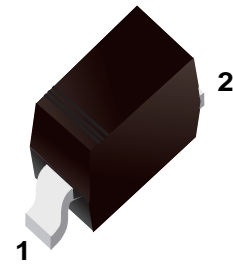

■ Simplified outline(SOD-323)

■ Absolute Maximum Ratings Ta = 25°C

Parameter	Symbol	Rating	Unit
Peak Repetitive Reverse Voltage	VRRM	100	V
Working Peak Reverse Voltage	VRWM		
DC Blocking Voltage	VR		
Forward Current	IF	150	mA
Peak Forward Surge Current@ tp < 1.0s, Duty Cycle < 50% (Note.1)	IFM	350	
Forward Surge Forward Current @ tp=10ms (Note.1)	IFSM	750	
Power Dissipation	Pd	200	
Thermal Resistance Junction to Ambient	RθJA	420	°C/W
		370	
Junction Temperature	TJ	150	°C
Storage Temperature range	Tstg	-55 to 150	

Note.1: Part mounted on FR-4 board with recommended pad layout

Note.2: Part mounted on Polyimide board with recommended pad layout

■ Electrical Characteristics Ta = 25°C

Parameter	Symbol	Test Conditions	Min	Typ	Max	Unit
Reverse breakdown voltage	VR	IR= 100 uA	100			V
Forward voltage	VF	IF= 0.1 mA			0.25	
		IF= 10 mA			0.45	
		IF= 250 mA			1	
Reverse voltage leakage current	IR1	VR= 1.5 V			0.3	uA
	IR2	VR= 10 V			0.5	
	IR3	VR= 50 V			1	
	IR4	VR= 75 V			2	
Total capacitance	CT	VR= 0 V, f= 1 MHz		20		pF
		VR= 1 V, f= 1 MHz		12		

■ Typical Characteristics

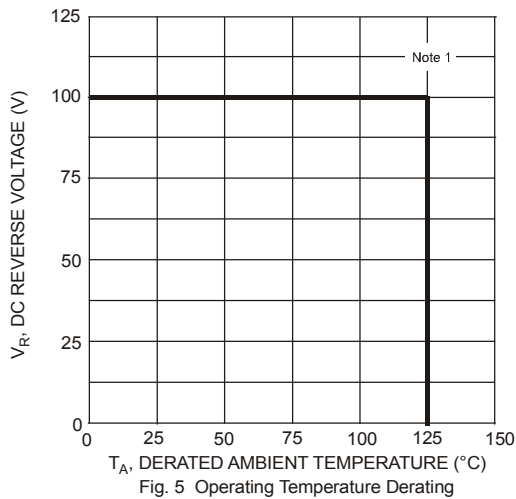
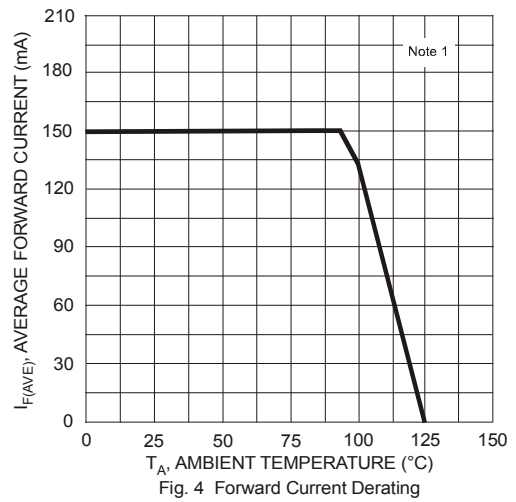
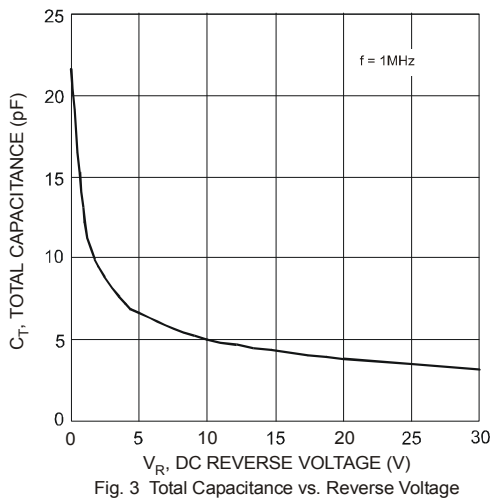
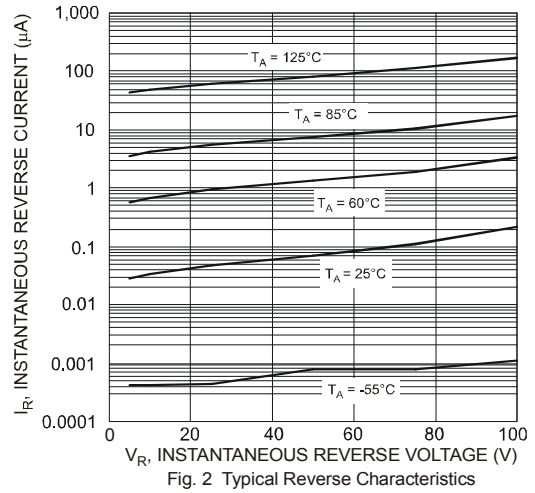
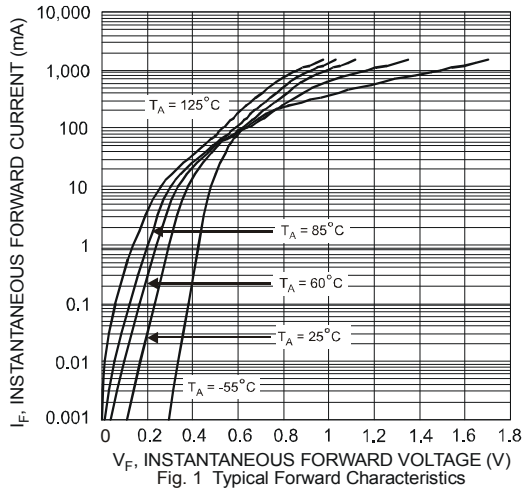

■ SOD-323

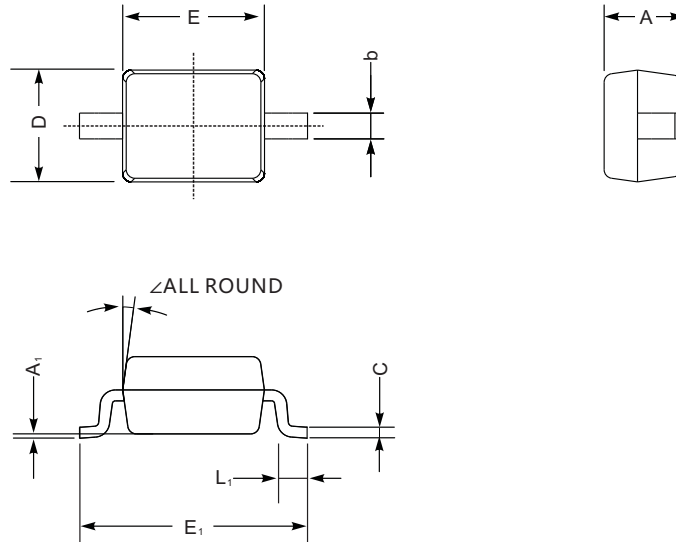

SOD-323 mechanical data

UNIT		A	C	D	E	E ₁	b	L ₁	A ₁	∠
mm	max	1.1	0.15	1.4	1.8	2.75	0.4	0.45	0.2	9°
	min	0.8	0.08	1.2	1.4	2.55	0.25	0.2	—	
mil	max	43	5.9	55	70	108	16	16	8	
	min	32	3.1	47	63	100	9.8	7.9	—	

■ The recommended mounting pad size

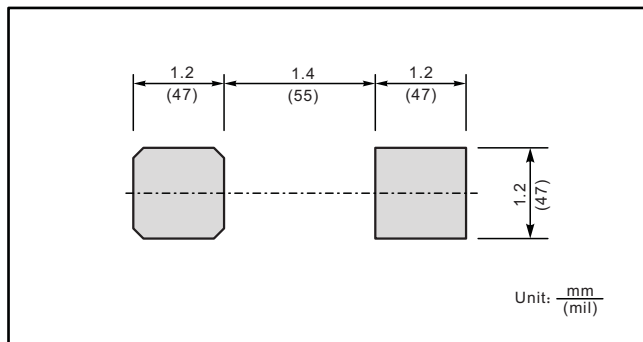

X-ON Electronics

Largest Supplier of Electrical and Electronic Components

Click to view similar products for [Schottky Diodes & Rectifiers](#) category:

Click to view products by [SLKORMICRO](#) manufacturer:

Other Similar products are found below :

[MA4E2039](#) [MA4E2508M-1112](#) [MBR1545CT](#) [MMBD301M3T5G](#) [RB160M-50TR](#) [D83C](#) [BAS16E6433HTMA1](#) [BAT 54-02LRH E6327](#)
[NRVBAF360T3G](#) [NSR05F40QNXT5G](#) [NTE555](#) [JANS1N6640](#) [SK310-T](#) [SK34B-TP](#) [SS3003CH-TL-E](#) [GA01SHT18](#)
[CRS10I30A\(TE85L,QM](#) [MA4E2501L-1290](#) [MBRA140TRPBF](#) [MBRB30H30CT-1G](#) [BAT 15-04R E6152](#) [JANTX1N5712-1](#) [DMJ3940-000](#)
[SB007-03C-TB-E](#) [SK33B-TP](#) [NRVBB20100CTT4G](#) [NRVBM120LT1G](#) [NTSB30U100CT-1G](#) [VS-6CWQ10FNHM3](#) [CRG04\(T5L,TEMQ\)](#)
[ACDBA1100LR-HF](#) [ACDBA1200-HF](#) [ACDBA240-HF](#) [ACDBA3100-HF](#) [CDBQC0530L-HF](#) [CDBQC0240LR-HF](#) [ACDBA260LR-HF](#)
[ACDBA1100-HF](#) [MA4E2502L-1246](#) [10BQ015-M3/5BT](#) [NRVBM120ET1G](#) [CRS08TE85LQM](#) [PMAD1108-LF](#) [B120Q-13-F](#) [1N5819T-G](#)
[B0530WSQ-7-F](#) [PDS1040Q-13](#) [B160BQ-13-F](#) [SDM05U20CSP-7](#) [B140S1F-7](#)