

Schottky Diodes

■ Features

- Fast Switching Speed
- For General Purpose Switching Applications.
- High Conductance

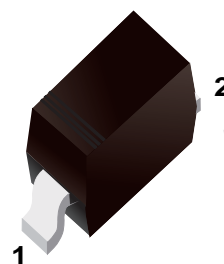

■ Simplified outline(SOD-323)

■ Absolute Maximum Ratings Ta = 25°C

Parameter	Symbol	Rating	Unit
Reverse Voltage	V_{RM}	10	V
Forward Current	I_F	3	A
Peak Forward Surge Current ($t \leq 10ms$)	I_{FM}	5	
Power Dissipation $T_S \leq 28^\circ C$	P_d	350	mW
Thermal Resistance Junction to Point ¹	$R_{\theta JS}$	≤ 90	K/W
Junction Temperature	T_J	150	°C
Operating Temperature Range	T_{OP}	-55 to 85	
Storage Temperature range	T_{stg}	-55 to 150	

NOTES:

1.For calculation of R_{thJA} please refer to Application Note Thermal Resistance

■ Electrical Characteristics Ta = 25°C

Parameter	Symbol	Test Conditions	Min	Typ	Max	Unit
Reverse breakdown voltage	V_R	$I_R = 100 \mu A$	10			V
Forward voltage	V_F	$I_F = 10 mA$			0.32	
		$I_F = 100 mA$			0.38	
		$I_F = 1000 mA$			0.58	
Reverse voltage leakage current	I_R	$V_R = 5 V$			1	mA
		$V_R = 8 V$			2.6	
		$V_R = 5 V, T_A = 80^\circ C$		18		
Junction capacitance	C_j	$V_R = 5 V, f = 1 MHz$			35	pF

■ Typical Characteristics

Reverse current $I_R = f(V_R)$

$T_A = \text{Parameter}$

Forward current $I_F = f(V_F)$

$T_A = \text{Parameter}$

Fig 1. Reverse Characteristic Curve

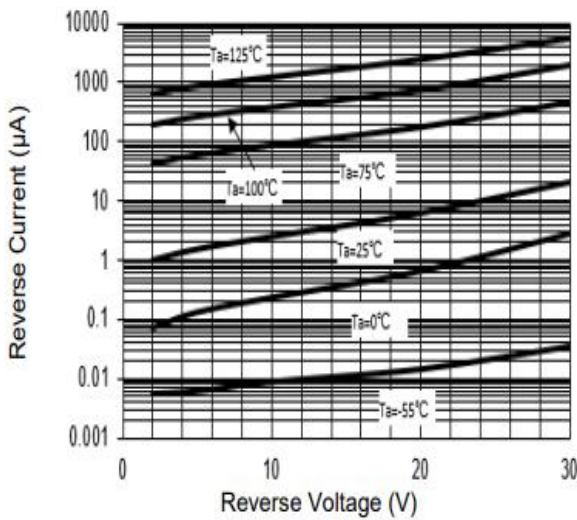

Fig 2. Forward Characteristic Curve

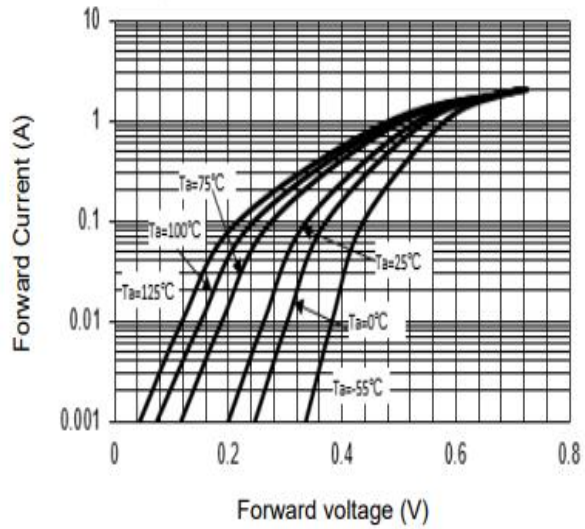

Fig 3. Junction Capacitance

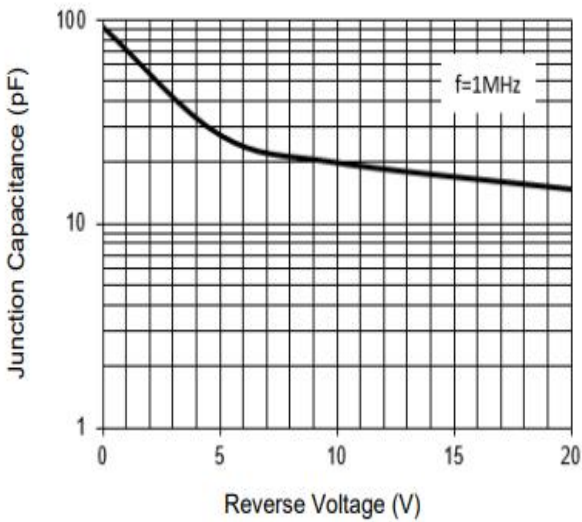
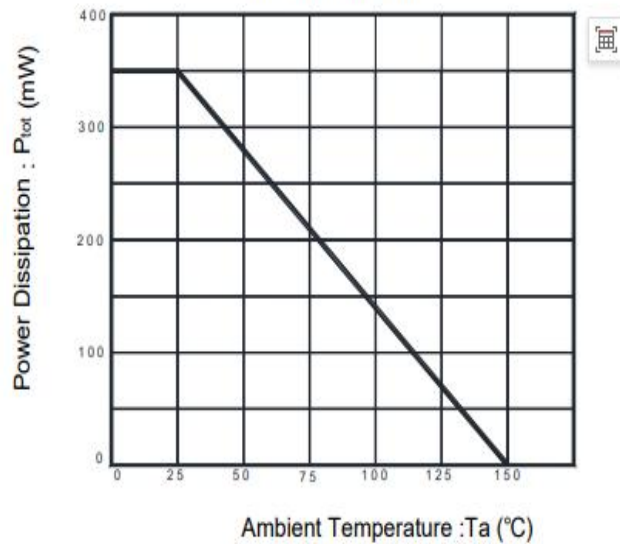
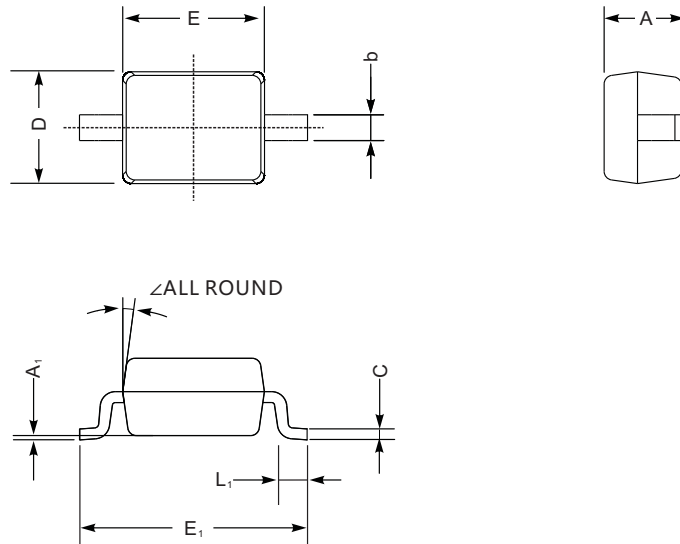
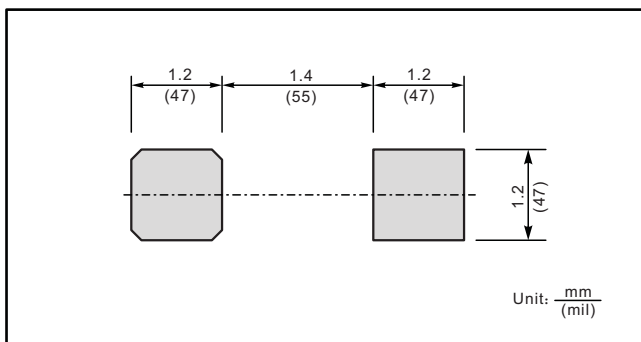

Fig 4. Derating Curve



■ SOD-323

SOD-323 mechanical data

UNIT		A	C	D	E	E ₁	b	L ₁	A ₁	∠
mm	max	1.1	0.15	1.4	1.8	2.75	0.4	0.45	0.2	9°
	min	0.8	0.08	1.2	1.4	2.55	0.25	0.2	—	
mil	max	43	5.9	55	70	108	16	16	8	
	min	32	3.1	47	63	100	9.8	7.9	—	

■ The recommended mounting pad size

X-ON Electronics

Largest Supplier of Electrical and Electronic Components

Click to view similar products for [Schottky Diodes & Rectifiers](#) category:

Click to view products by [SLKORMICRO](#) manufacturer:

Other Similar products are found below :

[MA4E2039](#) [MA4E2508M-1112](#) [MBR1545CT](#) [MMBD301M3T5G](#) [RB160M-50TR](#) [D83C](#) [BAS16E6433HTMA1](#) [BAT 54-02LRH E6327](#)
[NRVBAF360T3G](#) [NSR05F40QNXT5G](#) [NTE555](#) [JANS1N6640](#) [SK310-T](#) [SS3003CH-TL-E](#) [GA01SHT18](#) [CRS10I30A\(TE85L,QM](#)
[MA4E2501L-1290](#) [MBRA140TRPBF](#) [MBRB30H30CT-1G](#) [BAT 15-04R E6152](#) [JANTX1N5712-1](#) [DMJ3940-000](#) [SB007-03C-TB-E](#)
[SK33B-TP](#) [NRVBB20100CTT4G](#) [NRVBM120LT1G](#) [NTSB30U100CT-1G](#) [VS-6CWQ10FNHM3](#) [CRG04\(T5L,TEMQ\)](#) [ACDBA1100LR-HF](#)
[ACDBA1200-HF](#) [ACDBA240-HF](#) [ACDBA3100-HF](#) [CDBQC0530L-HF](#) [CDBQC0240LR-HF](#) [ACDBA260LR-HF](#) [ACDBA1100-HF](#)
[MA4E2502L-1246](#) [10BQ015-M3/5BT](#) [NRVBM120ET1G](#) [CRS08TE85LQM](#) [PMAD1108-LF](#) [B120Q-13-F](#) [1N5819T-G](#) [B0530WSQ-7-F](#)
[PDS1040Q-13](#) [B160BQ-13-F](#) [SDM05U20CSP-7](#) [B140S1F-7](#) [HSM560Je3/TR13](#)