

SOD-323 Plastic-Encapsulate Diodes

ZENER DIODE

FEATURE

- Planar Die Construction
- General Purpose, Medium Current
- Ideally Suited for Automated Assembly Processes
- Available in Lead Free Version

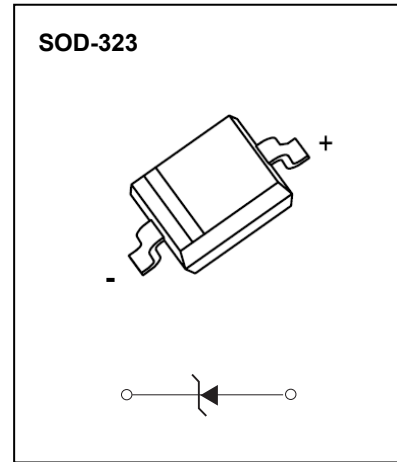

Maximum Ratings(Ta=25°C unless otherwise specified)

Characteristic	Symbol	Value	Unit
Forward Voltage (Note 2) @ I _F = 10mA	V _F	0.9	V
Power Dissipation(Note 1)	P _d	200	mW
Thermal Resistance from Junction to Ambient	R _{θJA}	625	/W
Operation Junction and Storage Temperature Range	T _J , T _{stg}	-55 ~ +150	

ELECTRICAL CHARACTERISTICS

T_a=25°C unless otherwise specified

Type Number	Type Code	Zener Voltage Range (Note 2)				Maximum Zener Impedance (Note 3)			Maximum Reverse Current		Typical Temperature Coefficient @I _{ZTC} mV/°C		Test Current I _{ZTC} mA
		V _Z @I _{ZT}			I _{ZT}	Z _{ZT} @I _{ZT}	Z _{ZK} @I _{ZK}	I _{ZK}	I _R	V _R	Min	Max	
		Nom(V)	Min(V)	Max(V)	mA	Ω		mA	μA	V			
BZT52B2V4S	2WX	2.4	2.35	2.45	5	100	600	1.0	50	1.0	-3.5	0	5
BZT52B2V7S	2W1	2.7	2.65	2.75	5	100	600	1.0	20	1.0	-3.5	0	5
BZT52B3V0S	2W2	3.0	2.94	3.06	5	95	600	1.0	10	1.0	-3.5	0	5
BZT52B3V3S	2W3	3.3	3.23	3.37	5	95	600	1.0	5	1.0	-3.5	0	5
BZT52B3V6S	2W4	3.6	3.53	3.67	5	90	600	1.0	5	1.0	-3.5	0	5
BZT52B3V9S	2W5	3.9	3.82	3.98	5	90	600	1.0	3	1.0	-3.5	0	5
BZT52B4V3S	2W6	4.3	4.21	4.39	5	90	600	1.0	3	1.0	-3.5	0	5
BZT52B4V7S	2W7	4.7	4.61	4.79	5	80	500	1.0	3	2.0	-3.5	0.2	5
BZT52B5V1S	2W8	5.1	5.00	5.20	5	60	480	1.0	2	2.0	-2.7	1.2	5
BZT52B5V6S	2W9	5.6	5.49	5.71	5	40	400	1.0	1	2.0	-2.0	2.5	5
BZT52B6V2S	2WA	6.2	6.08	6.32	5	10	150	1.0	3	4.0	0.4	3.7	5
BZT52B6V8S	2WB	6.8	6.66	6.94	5	15	80	1.0	2	4.0	1.2	4.5	5
BZT52B7V5S	2WC	7.5	7.35	7.65	5	15	80	1.0	1	5.0	2.5	5.3	5
BZT52B8V2S	2WD	8.2	8.04	8.36	5	15	80	1.0	0.7	5.0	3.2	6.2	5
BZT52B9V1S	2WE	9.1	8.92	9.28	5	15	100	1.0	0.5	6.0	3.8	7.0	5
BZT52B10S	2WF	10	9.80	10.20	5	20	150	1.0	0.2	7.0	4.5	8.0	5
BZT52B11S	2WG	11	10.78	11.22	5	20	150	1.0	0.1	8.0	5.4	9.0	5
BZT52B12S	2WH	12	11.76	12.24	5	25	150	1.0	0.1	8.0	6.0	10.0	5
BZT52B13S	2WI	13	12.74	13.26	5	30	170	1.0	0.1	8.0	7.0	11.0	5
BZT52B15S	2WJ	15	14.70	15.30	5	30	200	1.0	0.1	10.5	9.2	13.0	5
BZT52B16S	2WK	16	15.68	16.32	5	40	200	1.0	0.1	11.2	10.4	14.0	5
BZT52B18S	2WL	18	17.64	18.36	5	45	225	1.0	0.1	12.6	12.4	16.0	5
BZT52B20S	2WM	20	19.60	20.40	5	55	225	1.0	0.1	14.0	14.4	18.0	5
BZT52B22S	2WN	22	21.56	22.44	5	55	250	1.0	0.1	15.4	16.4	20.0	5
BZT52B24S	2WO	24	23.52	24.48	5	70	250	1.0	0.1	16.8	18.4	22.0	5
BZT52B27S	2WP	27	26.46	27.54	2	80	300	0.5	0.1	18.9	21.4	25.3	2
BZT52B30S	2WQ	30	29.40	30.60	2	80	300	0.5	0.1	21.0	24.4	29.4	2
BZT52B33S	2WR	33	32.34	33.66	2	80	325	0.5	0.1	23.1	27.4	33.4	2
BZT52B36S	2WS	36	35.28	36.72	2	90	350	0.5	0.1	25.2	30.4	37.4	2
BZT52B39S	2WT	39	38.22	39.78	2	130	350	0.5	0.1	27.3	33.4	41.2	2

- Notes: 1. Device mounted on ceramic PCB: 7.6mm x 9.4mm x 0.87mm with pad areas 25mm².
 2. Short duration test pulse used to minimize self-heating effect.
 3. f = 1kHz.

Typical Characteristics

Notes: Our company currently provide 5.1 V - 20 V products only

Zener Characteristics (V_z 5.1V to 20 V)

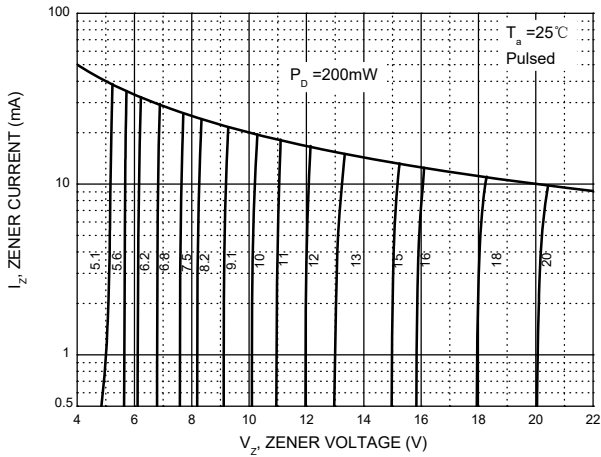

Temperature Coefficients

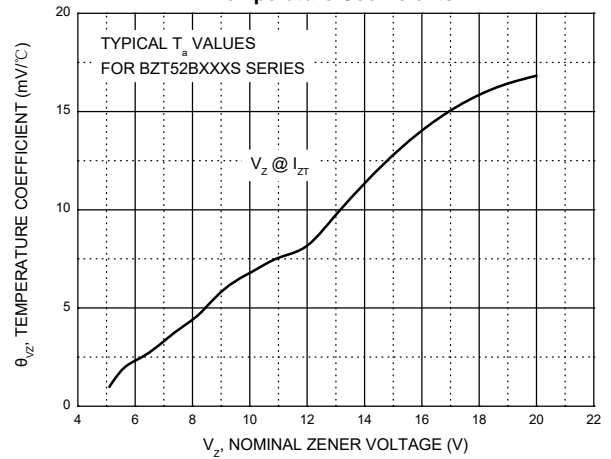

Typical Leakage Current

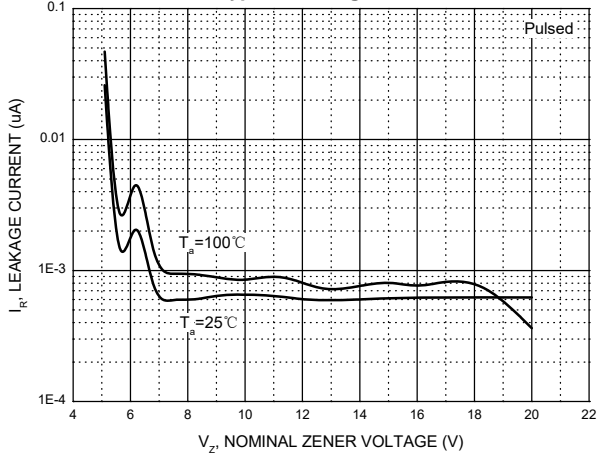

Typical Capacitance

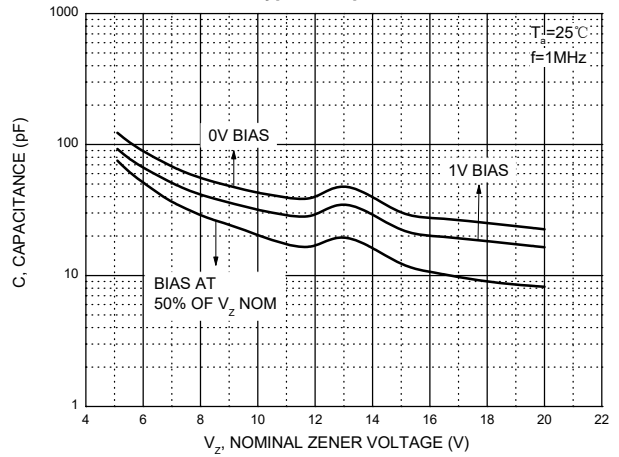

Effect of Zener Voltage on Zener Impedance

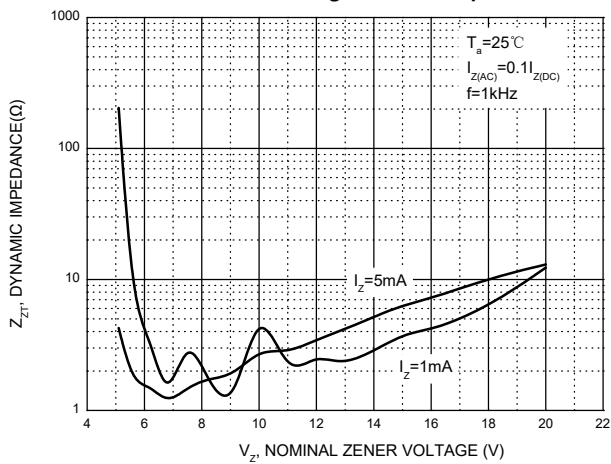

Power Derating Curve

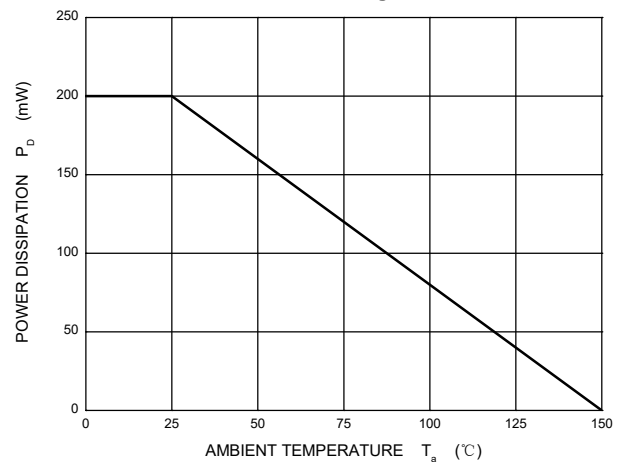

SOD-323 Tape and Reel

SOD-323 Embossed Carrier Tape

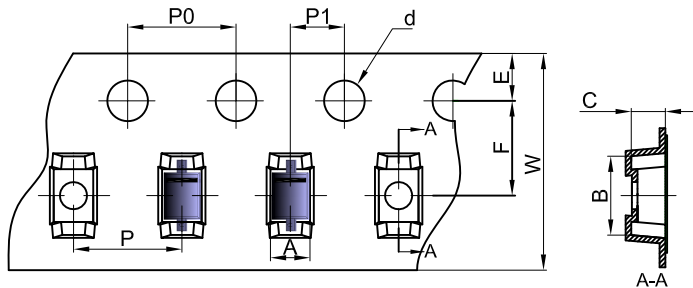

Packaging Description:

SOD-323 parts are shipped in tape. The carrier tape is made from a dissipative (carbon filled) polycarbonate resin. The cover tape is a multilayer film (Heat Activated Adhesive in nature) primarily composed of polyester film, adhesive layer, sealant, and anti-static sprayed agent. These reeled parts in standard option are shipped with 3,000 units per 7" or 17.8cm diameter reel. The reels are clear in color and is made of polystyrene plastic (anti-static coated).

Dimensions are in millimeter										
Pkg type	A	B	C	d	E	F	P0	P	P1	W
SOD-323	1.48	3.3	1.25	Ø1.50	1.75	3.50	4.00	4.00	2.00	8.00

SOD-323 Tape Leader and Trailer

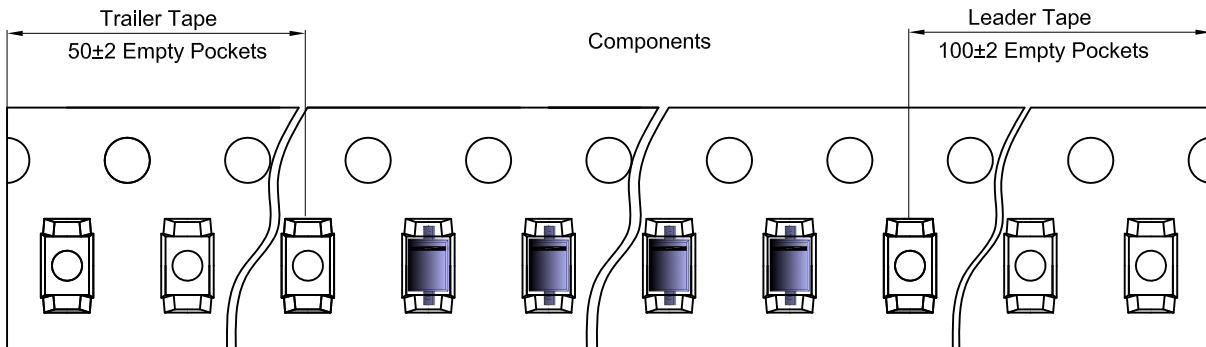

X-ON Electronics

Largest Supplier of Electrical and Electronic Components

Click to view similar products for [Zener Diodes](#) category:

Click to view products by [SLKORMICRO](#) manufacturer:

Other Similar products are found below :

[RKZ13B2KG#P1](#) [DL5234B](#) [1N4682](#) [1N4693](#) [1N4732A](#) [1N4736A](#) [1N4750A](#) [1N4759ARL](#) [1N5241B](#) [1N5365B](#) [1N5369B](#) [1N747A](#)
[1N964B](#) [1N966B](#) [1N968B](#) [1N972B](#) [JANS1N4974US](#) [1N4692](#) [1N4702](#) [1N4704](#) [1N4711](#) [1N4714](#) [1N4745ARL](#) [1N4752ARL](#) [1N4760ARL](#)
[1N5221B](#) [1N5242BTR](#) [1N5350B](#) [1N5352B](#) [1N961BRR1](#) [1N964BRL](#) [RKZ5.1BKU#P6](#) [3SMAJ5946B-TP](#) [3SMAJ5950B-TP](#)
[MMSZ5230BQ-13-F](#) [MMSZ5232BQ-13-F](#) [BZX84C7V5](#) [3SMAJ5945B-TP](#) [3SMAJ5947B-TP](#) [3SMBJ5941B-TP](#) [DZ2S240M0L](#) [SMAZ27-](#)
[TP](#) [ZMM5224B-7](#) [RD16UM-T1-A](#) [RD39S-T1-A](#) [RD10S-T1-A](#) [CDZT2R5.6B](#) [1N4762A G](#) [Z1SMA18](#) [JANTX1N4553B](#)