

DIGITAL TRANSISTOR (NPN)

Digital Transistors (Built-in Resistors)

FEATURES

- Built-in bias resistors enable the configuration of an inverter circuit without connecting external input resistors(see equivalent circuit)
- The bias resistors consist of thin-film resistors with complete isolation to allow negative biasing of the input.They also have the advantage of almost completely eliminating parasitic effects
- Only the on/off conditions need to be set for operation, making device design easy

• Equivalent Circuit

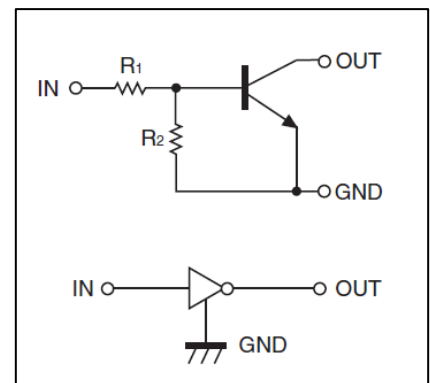

MARKING: 23

PIN CONNENCTIONS and MARKING

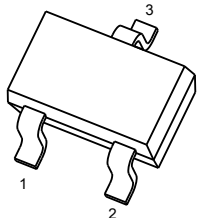
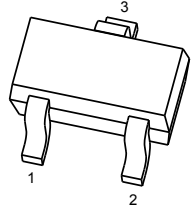
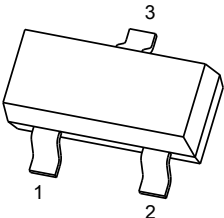
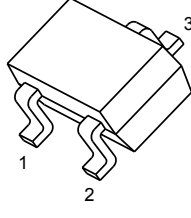
<p>DTC143EUA</p> 	<p>SOT-323</p> <p>1. IN 2. GND 3. OUT</p>	<p>DTC143EE</p> 	<p>SOT-523</p> <p>1. IN 2. GND 3. OUT</p>
<p>DTC143ECA</p> 	<p>SOT-23</p> <p>1. IN 2. GND 3. OUT</p>	<p>DTC143EKA</p> 	<p>SOT-23-3L</p> <p>1. IN 2. GND 3. OUT</p>

MAXIMUM RATINGS(Ta=25°C unless otherwise noted)

Symbol	Parameter	Limits(DTC143E□)					Unit
			E	UA	CA	KA	
V _{CC}	Supply Voltage	50					V
V _{IN}	Input Voltage	-10~+30					V
I _O	Output Current	100					mA
P _D	Power Dissipation		150	200	200	200	mW
T _J	Junction Temperature	150					°C
T _{stg}	Storage Temperature	-55~+150					°C

ELECTRICAL CHARACTERISTICS (Ta=25°C unless otherwise specified)

Parameter	Symbol	Conditions	Min	Typ	Max	Unit
Input voltage	V _{I(off)}	V _{CC} =5V, I _O =100μA	0.5			V
	V _{I(on)}	V _O =0.3V, I _O =20mA			3	V
Output voltage	V _{O(on)}	I _O /I _I =10mA/0.5mA			0.3	V
Input current	I _I	V _I =5V			1.8	mA
Output current	I _{O(off)}	V _{CC} =50V, V _I =0			0.5	μA
DC current gain	G _I	V _O =5V, I _O =10mA	20			
Input resistance	R ₁		3.29	4.7	6.11	kΩ
Resistance ratio	R ₂ /R ₁		0.8	1	1.2	
Transition frequency	f _T	V _O =10V, I _O =5mA, f=100MHz		250		MHz

Typical Characteristics

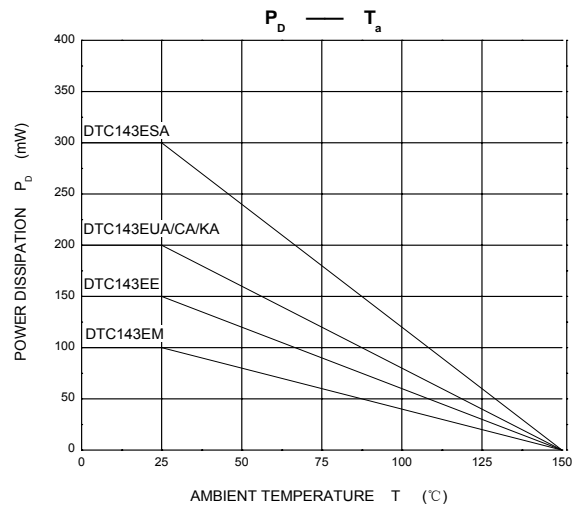
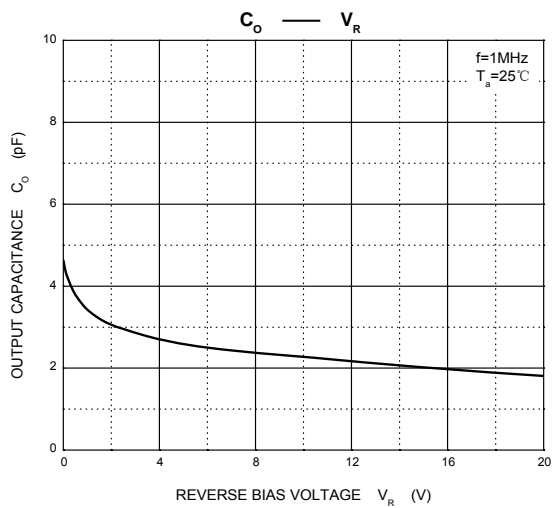
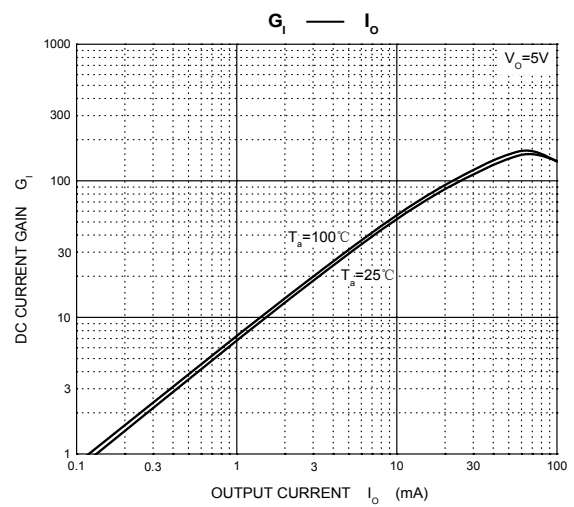
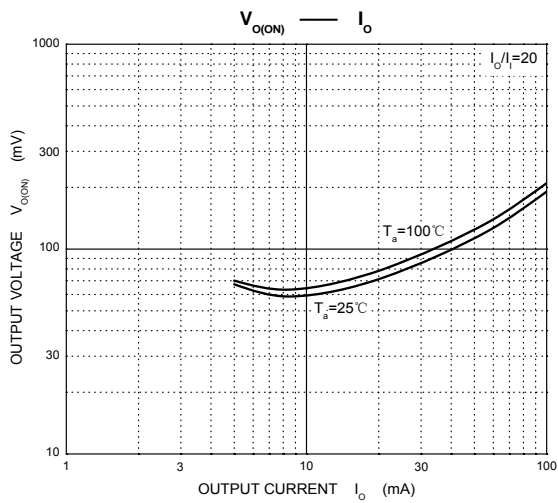
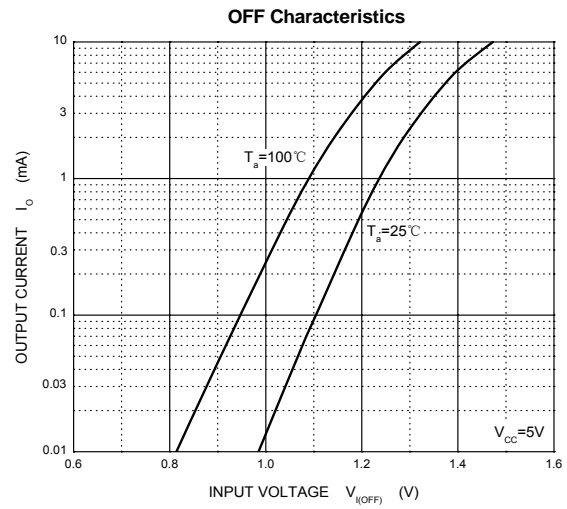
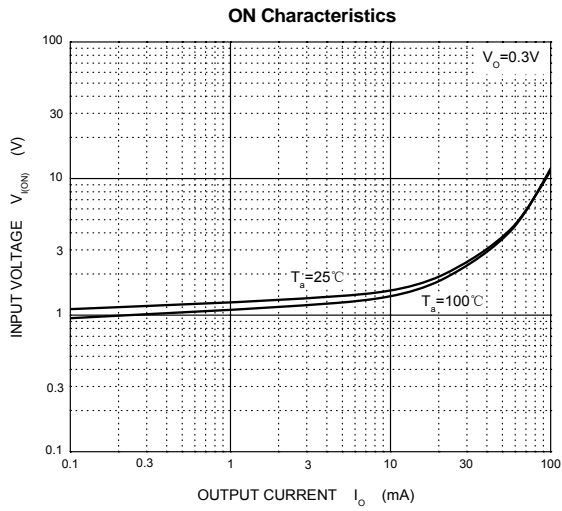

PACKAGE OUTLINE

Plastic surface mounted package; 3 leads

SOT-523

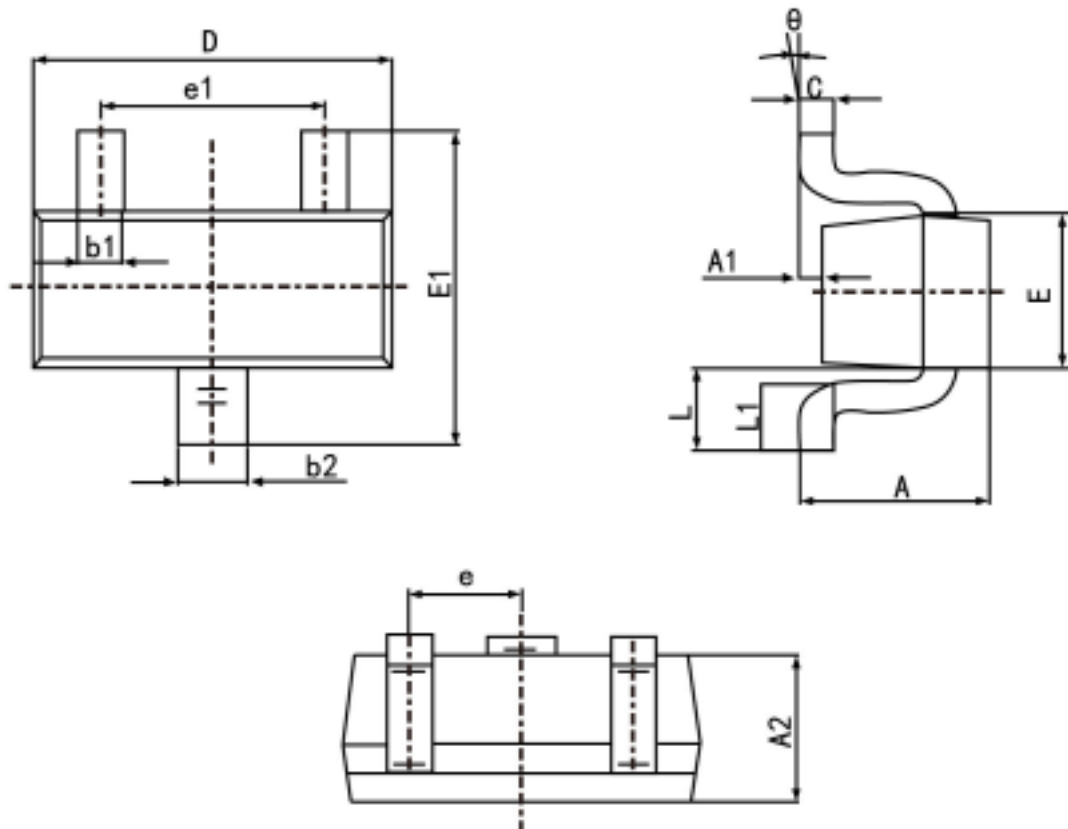

Symbol	Dimension in Millimeters	
	Min	Max
A	0.700	0.900
A1	0.000	0.100
A2	0.700	0.800
b1	0.150	0.250
b2	0.250	0.350
c	0.100	0.200
D	1.500	1.700
E	0.700	0.900
E1	1.450	1.750
e	0.500	TYP.
e1	0.900	1.100
L	0.400 REF.	
L1	0.260	0.460
θ	0°	8°

PACKAGE OUTLINE

Plastic surface mounted package; 3 leads

SOT-323

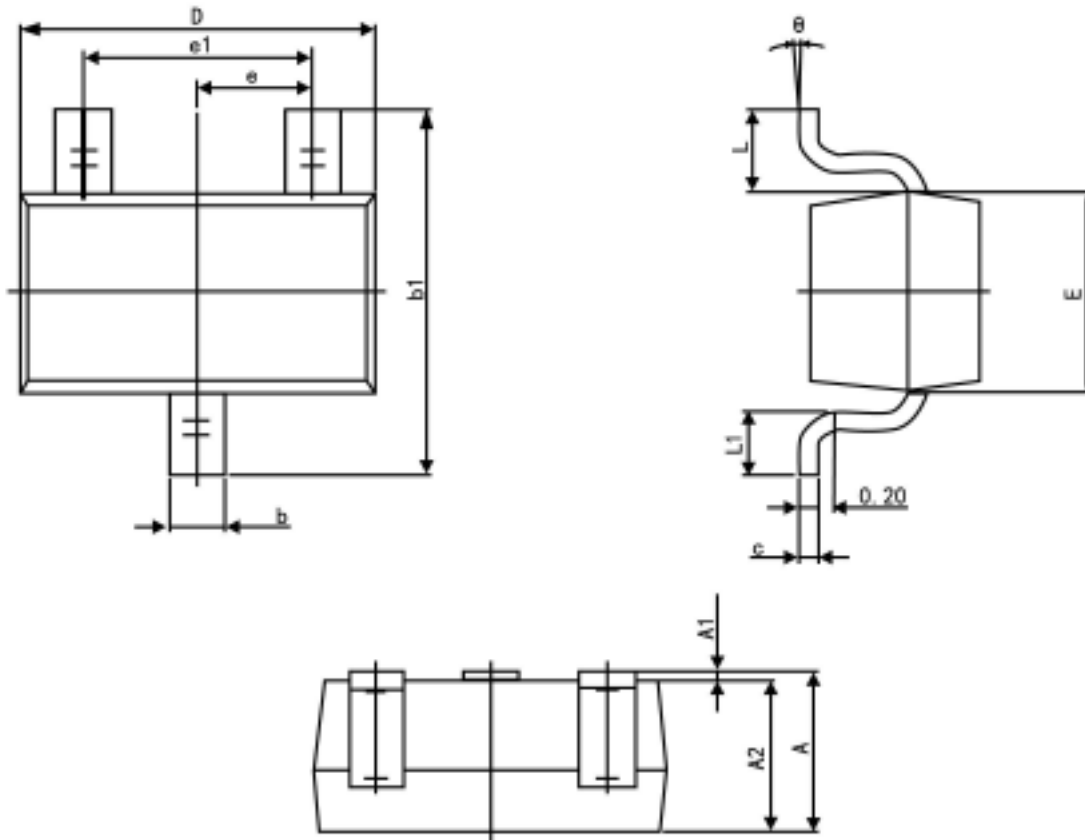

Symbol	Dimension in Millimeters	
	Min	Max
A	0.900	1.100
A1	0.000	0.100
A2	0.900	1.000
b	0.200	0.400
c	0.080	0.150
D	2.000	2.200
E	1.150	1.350
E1	2.150	2.450
e	0.650 TYP.	
e1	1.200	1.400
L	0.525 REF.	
L1	0.260	0.460
θ	0°	8°

Package outline dimensions SOT23-3L

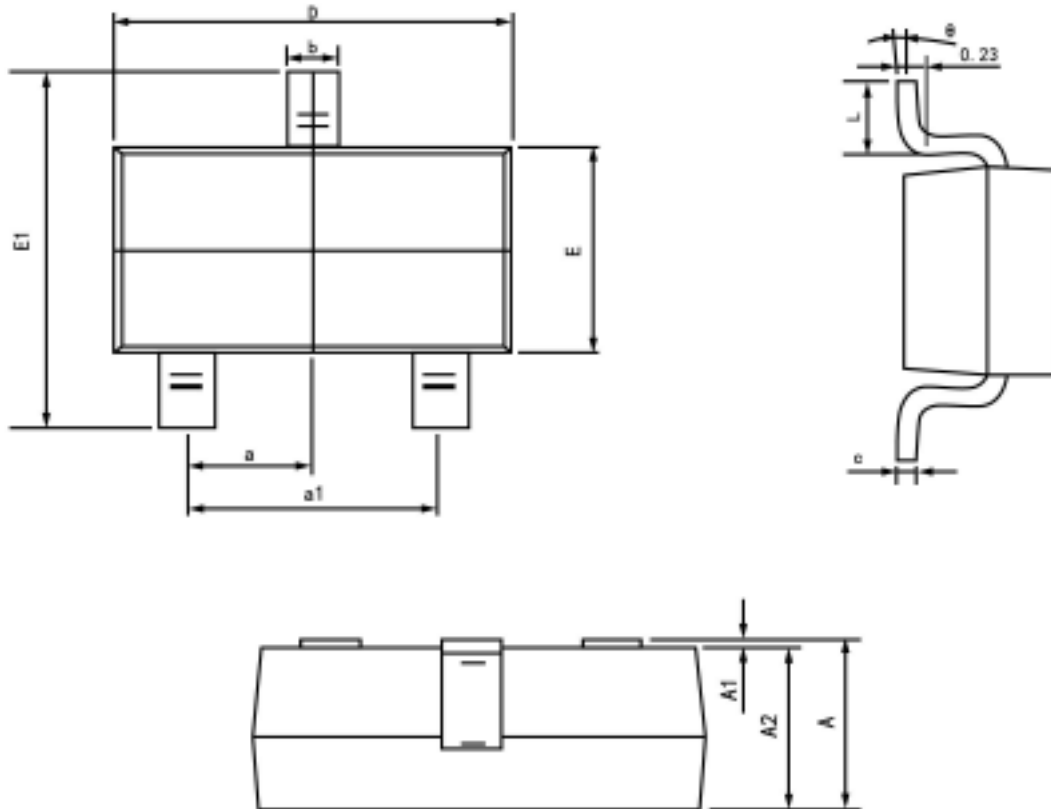

Symbol	Dimension in Millimeters	
	Min	Max
A	1.050	1.250
A1	0.000	0.100
A2	1.050	1.150
b	0.300	0.500
c	0.100	0.200
D	2.820	3.020
E	1.500	1.700
E1	2.650	2.950
e	0.950 (Basic)	
e1	1.800	2.000
L	0.300	0.600
θ	0°	8°

PACKAGE OUTLINE

Plastic surface mounted package; 3 leads

SOT-23

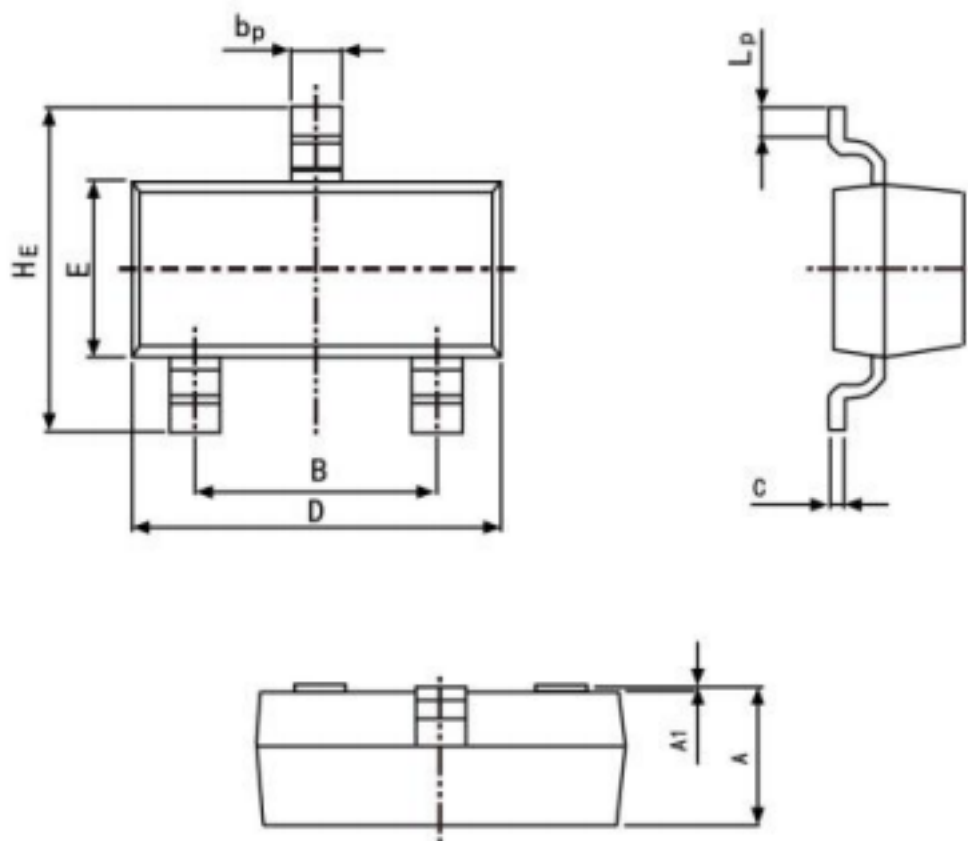

Symbol	Dimension in Millimeters	
	Min	Max
A	0.95	1.40
B	1.78	2.04
b_p	0.35	0.50
C	0.08	0.19
D	2.70	3.10
E	1.20	1.65
HE	2.20	3.00
A_1	0.100	0.013
L_p	0.20	0.50

X-ON Electronics

Largest Supplier of Electrical and Electronic Components

Click to view similar products for [Bipolar Transistors - Pre-Biased](#) category:

Click to view products by [SLKORMICRO](#) manufacturer:

Other Similar products are found below :

[DRC9A14E0L](#) [DTA124GKAT146](#) [DTA144WETL](#) [DTA144WKAT146](#) [DTC113EET1G](#) [DTC115TETL](#) [DTC115TKAT146](#)
[DTC144VUAT106](#) [MUN5241T1G](#) [BCR158WH6327XTSA1](#) [SMUN5330DW1T1G](#) [RN1306\(TE85L,F\)](#) [EMH15T2R](#) [NSBC143ZPDP6T5G](#)
[DTC114EUA-TP](#) [SMUN5237DW1T1G](#) [SMUN5213DW1T1G](#) [SMUN5114DW1T1G](#) [DTC124ECA-TP](#) [DTA114ECA-TP](#) [DTC113EM3T5G](#)
[NSVMUN5135DW1T1G](#) [NSVMUN2237T1G](#) [NSVDTC143ZM3T5G](#) [SMUN5335DW1T2G](#) [SMUN5216DW1T1G](#) [NSVMUN5316DW1T1G](#)
[NSVMUN5215DW1T1G](#) [NSVMUN5213DW1T3G](#) [NSVIMD10AMT1G](#) [NSVEMC2DXV5T1G](#) [NSVDTC144WET1G](#) [NSVDTC123JET1G](#)
[NSVDTA143EM3T5G](#) [NSVB1706DMW5T1G](#) [NSBC143EDP6T5G](#) [NSBA144WDXV6T1G](#) [DTA115TET1G](#) [NSBC115TDP6T5G](#)
[NSBA113EF3T5G](#) [MUN2235T1G](#) [NSBC143ZDXV6T5G](#) [NSVDTA114EM3T5G](#) [MUN2138T1G](#) [DCX124EUQ-7-F](#) [MUN2141T1G](#)
[DTC144TET1G](#) [MUN2238T1G](#) [SMUN5112DW1T1G](#) [NSVMUN5131T1G](#)