

SURFACE MOUNT SUPERFAST RECOVERY RECTIFIER

Reverse Voltage - 50 to 600 Volts Forward Current - 5.0 Amperes

SMBF	FEATURES							
<p style="text-align: center;">Dimensions in inches and (millimeters)</p>	<ul style="list-style-type: none"> ◆ For surface mounted applications ◆ Low profile package ◆ Glass Passivated Chip Junction ◆ Superfast reverse recovery time ◆ Lead free in comply with EU RoHS 2011/65/EU directives 							
	MECHANICAL DATA							
<p>Case: JEDEC SMBF molded plastic body Terminals: leads solderable per MIL-STD-750, Method 2026 Mounting Position: Any Weight: 57mg/0.002oz</p>								
MAXIMUM RATINGS AND ELECTRICAL CHARACTERISTICS								
<p>Ratings at 25°C ambient temperature unless otherwise specified. Single phase half-wave 60Hz, resistive or inductive load, for capacitive load current derate by 20%.</p>								
TWGMC Catalog Number	SYMBOLS	ES5ABF	ES5BBF	ES5DBF	ES5GBF	ES5JBF	UNITS	
Marking code								
Maximum repetitive peak reverse voltage	V_{RRM}	50	100	200	400	600	VOLTS	
Maximum RMS voltage	V_{RMS}	35	70	140	280	420	VOLTS	
Maximum DC blocking voltage	V_{DC}	50	100	200	400	600	VOLTS	
Maximum average forward rectified current at $T_L=100^\circ\text{C}$	$I_{(AV)}$	5.0						Amps
Peak forward surge current 8.3ms single half sine-wave superimposed on rated load (JEDEC Method)	I_{FSM}	150			135			Amps
Maximum instantaneous forward voltage at 5.0A	V_F	1.0			1.25	1.7		Volts
Maximum DC reverse current $T_A=25^\circ\text{C}$ at rated DC blocking voltage $T_A=125^\circ\text{C}$	I_R	10.0 100.0						μA
Maximum reverse recovery time (NOTE 1)	t_{rr}	35						ns
Typical junction capacitance (NOTE 2)	C_J	95						pF
Typical thermal resistance (NOTE 3)	$R_{\theta JA}$	45						$^\circ\text{C/W}$
Operating junction and storage temperature range	T_J, T_{STG}	-55 to +150						$^\circ\text{C}$
<p>Note: 1. Reverse recovery condition $I_F=0.5\text{A}, I_R=1.0\text{A}, I_{rr}=0.25\text{A}$ 2. Measured at 1MHz and applied reverse voltage of 4.0V D.C. 3. P.C.B. mounted with 0.5x0.5" (12.7x12.7mm) copper pad areas</p>								

Fig.1 Reverse Recovery Time Characteristic And Test Circuit Diagram

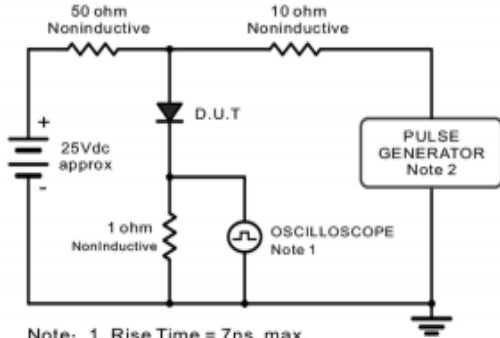

Note: 1. Rise Time = 7ns, max.
Input Impedance = 1 megohm, 22pF.
2. Rise Time = 10ns, max.
Source Impedance = 50 ohms.

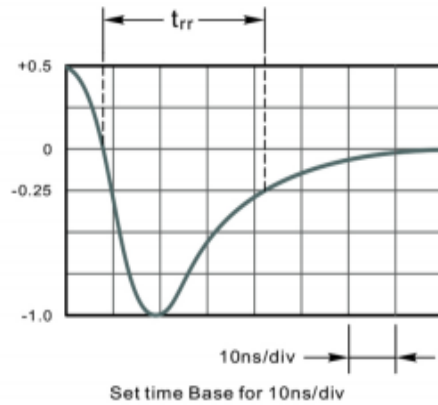

Fig.2 Maximum Average Forward Current Rating

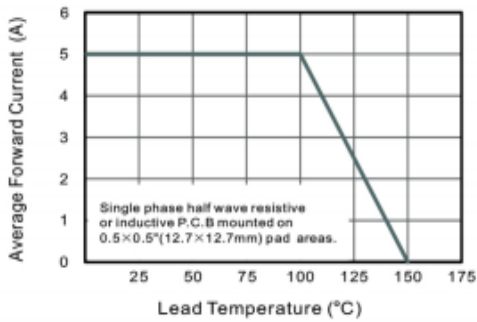

Fig.3 Typical Reverse Characteristics

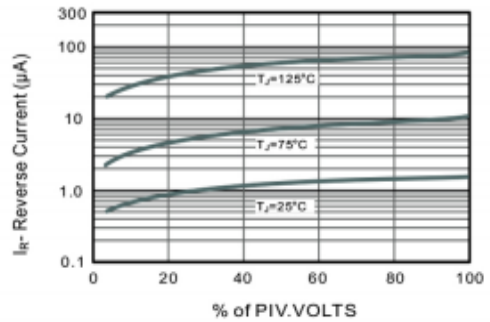

Fig.4 Typical Forward Characteristics

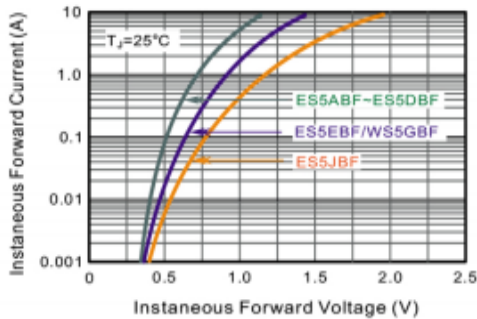

Fig.5 Typical Junction Capacitance

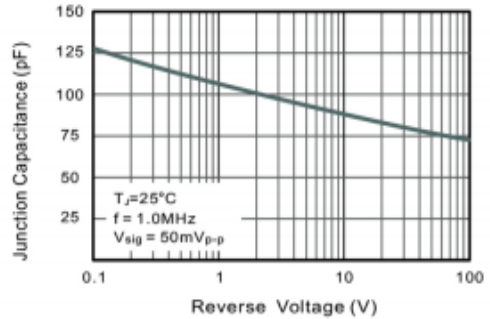
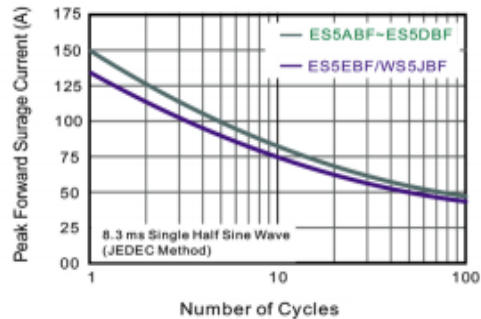

Fig.6 Maximum Non-Repetitive Peak Forward Surge Current



X-ON Electronics

Largest Supplier of Electrical and Electronic Components

Click to view similar products for [Rectifiers](#) category:

Click to view products by [SLKORMICRO](#) manufacturer:

Other Similar products are found below :

[70HFR40](#) [FR105 R0](#) [RL252-TP](#) [1N5397](#) [1N4005-TR](#) [1N4007-BP](#) [UFS120Je3/TR13](#) [20ETS12S](#) [RRE02VS6SGTR](#) [MS306](#) [A1N5404G-G](#)
[CRF02\(T5L,TEMQ\)](#) [ACGRB207-HF](#) [CLH07\(TE16L,Q\)](#) [CLH03\(TE16L,Q\)](#) [1N5395-TP](#) [UES1302](#) [ACGRC307-HF](#) [ACEFC304-HF](#) [DZ-](#)
[1380](#) [85HFR60](#) [40HFR60](#) [70HF120](#) [85HFR80](#) [SCF7500](#) [SM100](#) [ACGRA4001-HF](#) [SKN70/08](#) [NTE5819](#) [NTE5827](#) [NTE5828](#) [NTE5911](#)
[NTE5915](#) [NTE6104](#) [NTE6163](#) [NTE6164](#) [NTE6165](#) [NTE6364](#) [TSD3G](#) [SET130312](#) [NRVUS110VT3G](#) [UES1106](#) [UES1306](#)
[NRVUS240VT3G](#) [D5FE60-5063](#) [R4000GPS-TP](#) [D4015L56TP](#) [UES1306HR2](#) [FX20K120](#) [D20XB60-7101](#)