

Bidirectional Ultra Low Capacitance TVS Array

DESCRIPTION

The GBLC03CI Series are ultra low capacitance transient voltage suppressor arrays, designed to protect applications such as portable electronics and SMART phones. This series is available in both unidirectional and bidirectional configurations and is rated at 350 Watts for an 8/20 μ s waveshape.

The GBLC03CI and Series meets IEC 61000-4-2 (ESD) and IEC 61000-4-4 (EFT) requirements. At higher operating frequencies or faster edge rates, insertion loss and signal integrity are a major concern. This series offers a ultra low capacitance and low leakage current in a miniature SOD-323 package.

APPLICATIONS

- ◇ Cell Phone Handsets and Accessories
- ◇ Microprocessor based equipment
- ◇ Personal Digital Assistants (PDA's)
- ◇ Notebooks, Desktops, and Servers
- ◇ Portable Instrumentation
- ◇ Peripherals
- ◇ USB Interface

FEATURES

- ◇ IEC61000-4-2 (ESD) \pm 15kV (air), \pm 8kV (contact)
- ◇ IEC61000-4-4 (EFT) 40A (5/50 η s)
- ◇ IEC61000-4-5 (Lightning) 12A (8/20 μ s)
- ◇ Protects one I/O line (bidirectional)
- ◇ Low clamping voltage
- ◇ Working voltages : 3V, 5V, 8V, 12V, 15V, 24V
- ◇ Low leakage current
- ◇ Response Time is < 1 ns

MACHANICAL DATA

- ◇ SOD-323 package
- ◇ Flammability Rating: UL 94V-0
- ◇ Packaging: Tape and Reel
- ◇ High temperature soldering guaranteed:260 $^{\circ}$ C/10s
- ◇ Reel size: 7 inch
- ◇ Quantity per reel: 3,000pcs

PIN CONFIGURATION

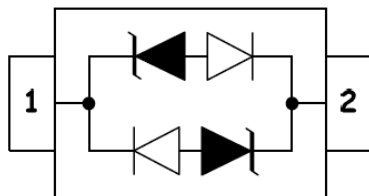

PACKAGE OUTLINE



ABSOLUTE MAXIMUM RATING			
Symbol	Parameter	Value	Units
V_{ESD}	ESD per IEC 61000-4-2 (Air)	± 15	kV
	ESD per IEC 61000-4-2 (Contact)	± 8	
P_{PP}	Peak Pulse Power (8/20 μ s)	350	W
T_{OPT}	Operating Temperature	-55/+150	$^{\circ}$ C
T_{STG}	Storage Temperature	-55/+150	$^{\circ}$ C
T_L	Lead Soldering Temperature	260	$^{\circ}$ C

ELECTRICAL CHARACTERISTICS (Tamb=25 $^{\circ}$ C)										
PART NUMBER	DEVICE MARKING	V_{RWM}	$V_B@1mA$	$V_C@1A$	$V_C@I_{pp}$		$V_C@I_{pp}$		I_R (μ A) Max	C_T (pF) Typ.
		(V) Max	(V) Min	(V) Max	(V) Max	I_{pp} (A) ()	(V) Max	I_{pp} (A) ()		
GBLC03CI	CC	3.0	4.0	7.0	13.9	8	20.0	20	5	0.8
GBLC05CI	AC	5.0	6.0	9.8	18.3	8	20.0	18	1	0.8
GBLC08CI	BC	8.0	8.5	13.4	18.5	8	24.0	18	1	0.8
GBLC12CI	DC	12.0	13.3	19.0	24.0	6	28.6	12	1	0.8
GBLC15CI	EC	15.0	16.7	24.0	29.0	5	31.8	10	1	0.8
GBLC24CI	HC	24.0	26.7	43.0	45.0	3	56.0	6	1	0.8

ELECTRICAL CHARACTERISTICS CURVE

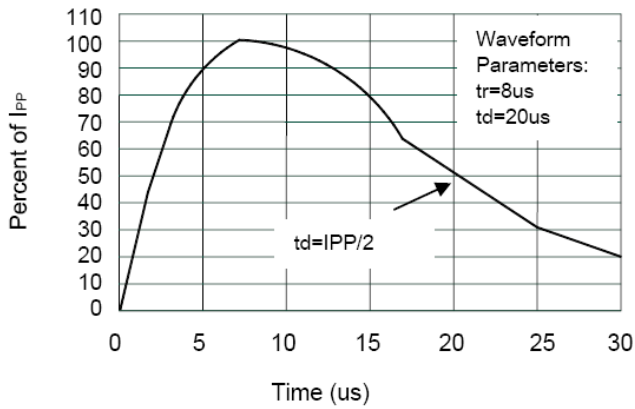

Pulse Waveform

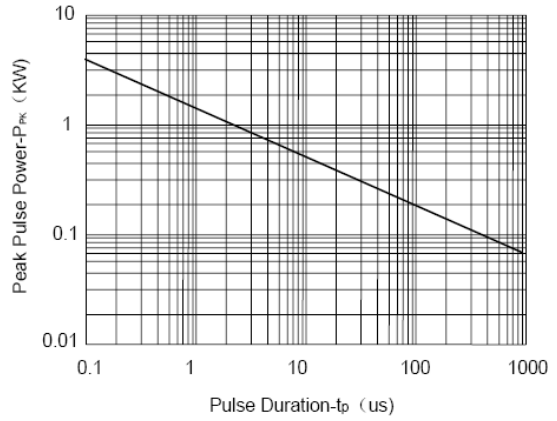

Non-Repetitive Peak Pulse Power vs. Pulse Time

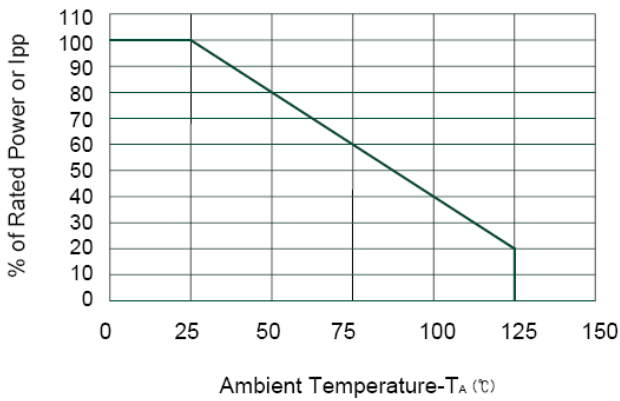

Power Derating Curve

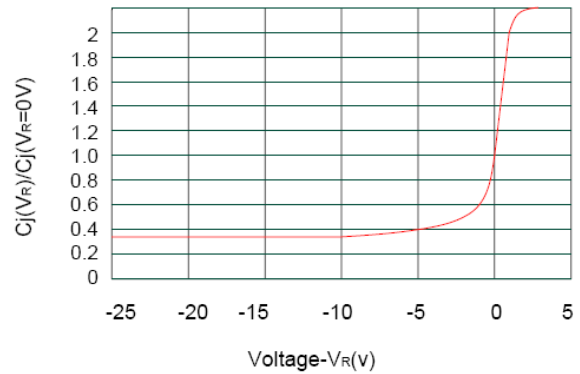

Junction Capacitance vs. Reverse Voltage

SOD-323 PACKAGE OUTLINE DIMENSIONS

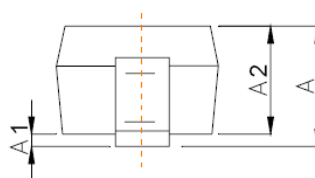
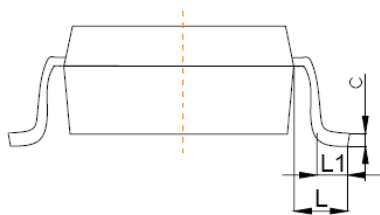
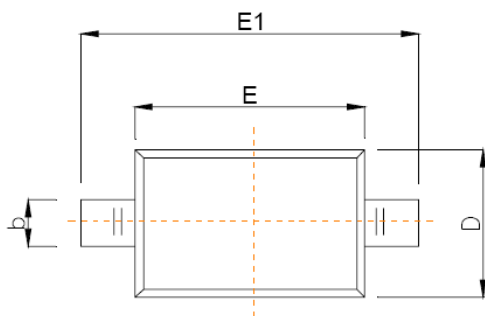

Symbol	Dimensions In Millimeters	
	Min	Max
A		1.00
A1	0.000	0.100
A2	0.800	0.900
b	0.250	0.350
c	0.080	0.150
D	1.200	1.400
E	1.600	1.800
E1	2.500	2.700
e	1.800	2.040
L	0.475 REF	
L1	0.250	0.400
θ	0°	8°

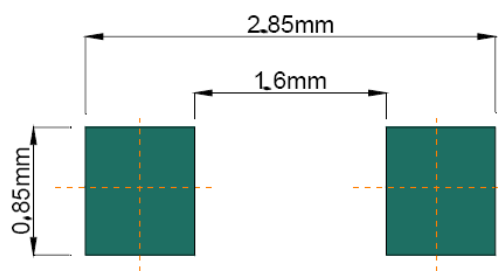

Recommended Pad outline

X-ON Electronics

Largest Supplier of Electrical and Electronic Components

Click to view similar products for [ESD Suppressors / TVS Diodes](#) category:

Click to view products by [SLKORMICRO](#) manufacturer:

Other Similar products are found below :

[60KS200C](#) [D18V0L1B2LP-7B](#) [D5V0F4U5P5-7](#) [NTE4902](#) [P4KE27CA](#) [P6KE11CA](#) [P6KE8.2A](#) [SA60CA](#) [SA64CA](#) [SMBJ12CATR](#)
[SMBJ33CATR](#) [SMBJ6.5A](#) [SMBJ8.0A](#) [ESD101-B1-02ELS](#) [E6327](#) [ESD112-B1-02EL](#) [E6327](#) [ESD7451N2T5G](#) [19180-510](#) [CPDT-5V0USP-](#)
[HF](#) [3.0SMCJ33CA-F](#) [3.0SMCJ36A-F](#) [HSPC16701B02TP](#) [JANTX1N6126A](#) [D3V3Q1B2DLP3-7](#) [D55V0M1B2WS-7](#) [SCM1293A-04SO](#)
[ESD200-B1-CSP0201](#) [E6327](#) [SM12-7](#) [CEN955 W/DATA](#) [VESD12A1A-HD1-GS08](#) [CPDQC5V0-HF](#) [D1213A-01LP4-7B](#) [ESD101-B1-02EL](#)
[E6327](#) [AOZ8808DI-03](#) [5KP15A](#) [5KP48A](#) [5KP90A](#) [ESD3V3D7-TP](#) [15KPA36A-LF](#) [P4KE56CA](#) [P4KE68A](#) [P4KE91CATR](#) [P6KE120A](#)
[P6KE13CA](#) [P6KE43CA](#) [P6KE6.8CA](#) [P6KE8.2](#) [P6SMBJ20CA](#) [JANTX1N6072A](#) [SR2835ESKG](#) [SA90CA](#)