

## 3 A Single-Phase Bridge Rectifier

Rectifier Reverse Voltage 50 to 1000V

### KBP

#### Features

- This series is UL listed under the Recognized Component Index, file number E484648
- Ideal for printed circuit board mounting
- The plastic material used carries Underwriters Laboratory flammability recognition 94V-0
- Built-in printed circuit board stand-offs
- High case dielectric strength
- High temperature soldering guaranteed 265°C /10 seconds at 5 lbs (2.3kg) tension

#### Mechanical Data

Case: Reliable low cost construction utilizing molded plastic technique  
 Terminals: Plated leads solderable per MIL-STD-202, Method 208  
 Mounting Position: Any

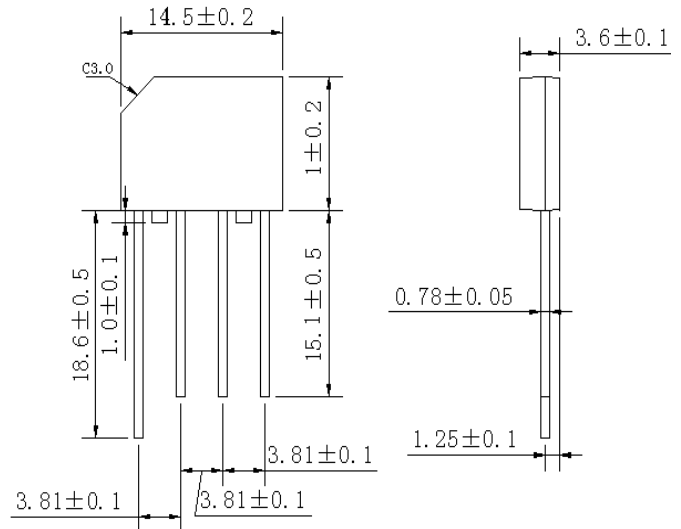

Dimensions in millimeters (1mm = 0.0394")

#### Maximum Ratings & Thermal Characteristics

Rating at 25°C ambient temperature unless otherwise specified, Resistive or Inductive load, 60 Hz.  
 For Capacitive load derate current by 20%.

Parameter	Symbol	KBP301	KBP302	KBP303	KBP304	KBP305	KBP306	KBP307	unit
Maximum repetitive peak reverse voltage	VRRM	50	100	200	400	600	800	1000	V
Maximum RMS bridge input voltage	VRMS	35	70	140	280	420	560	700	V
Maximum DC blocking voltage	VDC	50	100	200	400	600	800	1000	V
Maximum average forward rectified output current at TA=40°C	IF(AV)	3							A
Peak forward surge current single sine-wave superimposed on rated load (JEDEC Method)	IFSM	60							A
Operating junction and storage temperature range	TJ, TSTG	-55 to + 150							°C

#### Electrical Characteristics

Rating at 25°C ambient temperature unless otherwise specified. Resistive or Inductive load, 60Hz.  
 For Capacitive load derate by 20 %.

Parameter	Symbol	KBP301	KBP302	KBP303	KBP304	KBP305	KBP306	KBP307	Unit	
Maximum instantaneous forward voltage drop per leg at 3.0A	VF	1.1								V
Maximum DC reverse current at rated TA =25°C DC blocking voltage per element TA =125°C	IR	10				500				µA

Notes: (1) Thermal resistance from Junction to Ambient on P.C. board mounting.  
 (2) Measured at 2.0MHz and applied reverse voltage of 4.0 volts.

## Rating and Characteristic Curves ( $T_A=25^\circ\text{C}$ Unless otherwise noted )

**Fig. 1 Derating Curve for Output Rectified Current**

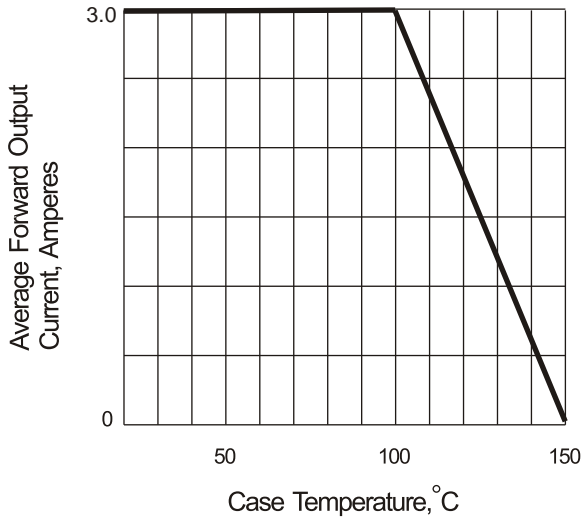

**Fig. 2 Maximum Non-repetitive Peak Forward Surge Current**

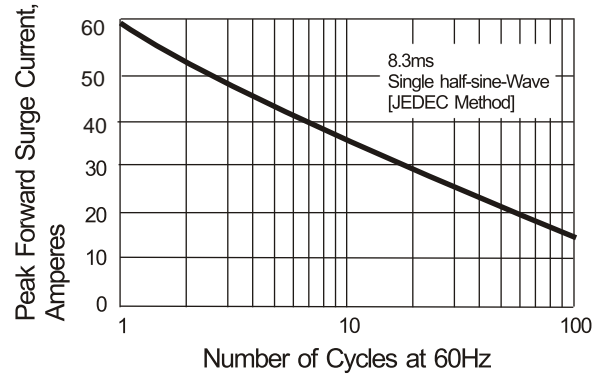

**Fig. 3 Typical Instantaneous Forward Characteristics**

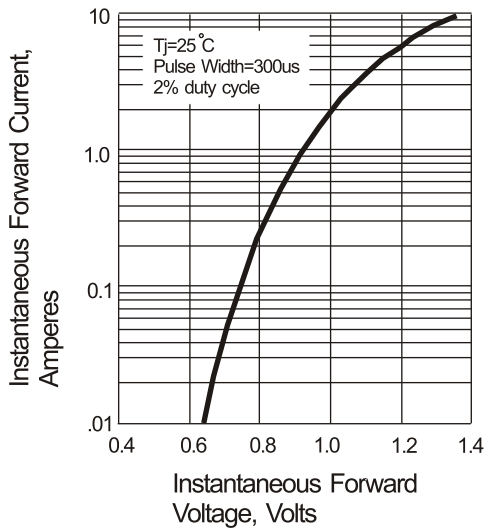

**Fig. 4 Typical Reverse Characteristics**

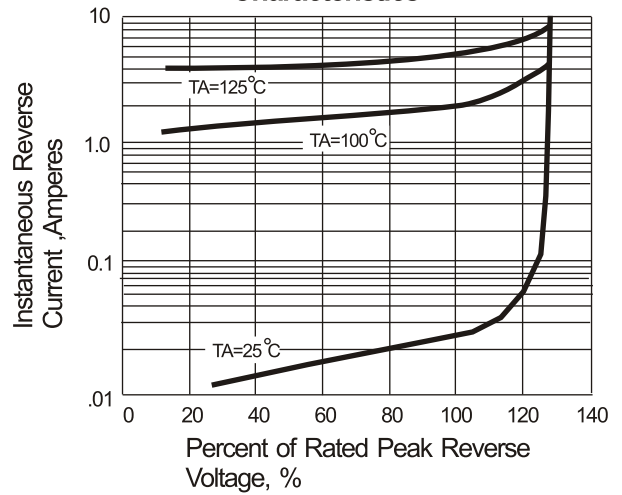

**Fig. 5 Typical Junction Capacitance**

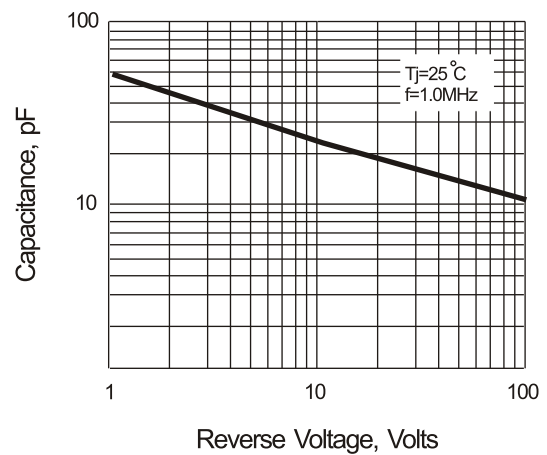

## X-ON Electronics

Largest Supplier of Electrical and Electronic Components

*Click to view similar products for [Bridge Rectifiers](#) category:*

*Click to view products by [SLKORMICRO](#) manufacturer:*

Other Similar products are found below :

[MB2510](#) [MB252](#) [MB356G](#) [MB358G](#) [90MT160KPBF](#) [GBJ1504-BP](#) [GBU10B-BP](#) [GBU15K-BP](#) [GBU4A-BP](#) [GBU4D-BP](#) [GBU6B-E3/45](#)  
[DB101-BP](#) [DF01](#) [DF10SA-E345](#) [BU1508-E3/45](#) [BU1510-E3/45](#) [KBPC50-10S](#) [RS405GL-BP](#) [GBJ1502-BP](#) [GBU6M](#) [GSIB1520-E3/45](#)  
[2KBB10](#) [36MB140A](#) [TB102M](#) [MB1510](#) [MB86](#) [TL401G](#) [MDA920A2](#) [TU602](#) [TU810](#) [MP5010W-BP](#) [MP501W-BP](#) [MP502-BP](#)  
[BR84DTP204](#) [BU1508-E3/51](#) [KBPC25-02](#) [VS-110MT120KPBF](#) [VS-2KBB60](#) [VS-60MT120KPBF](#) [VS-60MT80KPBF](#) [DB105-BP](#) [DF1510S](#)  
[VS-40MT160PAPBF](#) [VISKBU8K-E4/51](#) [36MT100](#) [GBU4G-BP](#) [GBU6B-E3/51](#) [DF15005S-E3/77](#) [GSIB15A80-E3/45](#) [DB104-BP](#)