

## 1A & 3A Miniconverter Switching Regulators

### Description

The LM2575/6 series switching regulators are monolithic integrated circuits designed for use in “buck” or “buck/boost” regulator applications requiring accurate output voltages over combined variations of line, load and temperature. This unique series greatly simplifies switching power supply design. The LM2575 has a maximum output current of 1A and the LM2576 is rated for 3A.

The LM2575/6 series miniconverters include a switching regulator and compensation network all within the same package. Just add a choke, catch diode and two capacitors to obtain an efficient DC-to-DC converter. The current limit and thermal shutdown features of the LM2575/6 series fully protect the device against overstress conditions.

The LM2575/6 series offers an alternative to popular 3 terminal linear regulators by providing higher efficiency with reduced heatsink size. In many applications a heat sink will not be required.

### Features

- ◆ Pin for pin replacement for National’s LM2575/6 series
- ◆ DC-to-DC buck or buck/boost converter requiring only 4 support components
- ◆ Fixed or adjustable voltages
- ◆ Preset output voltages of 3.3V, 5V and 12V
- ◆ Wide output voltage range, 1.23V to 35V
- ◆ 82% typical efficiency @ 5V out
- ◆ Wide input voltage range, 4V to 40V
- ◆ Inhibit/enable control pin
- ◆ Industrial temperature range
- ◆ TO-220 and TO-263 packages

### Applications

- ◆ Micro controller power supplies
- ◆ Medical equipment
- ◆ Industrial power supplies
- ◆ Instrumentation power supplies

### Typical Application Circuits

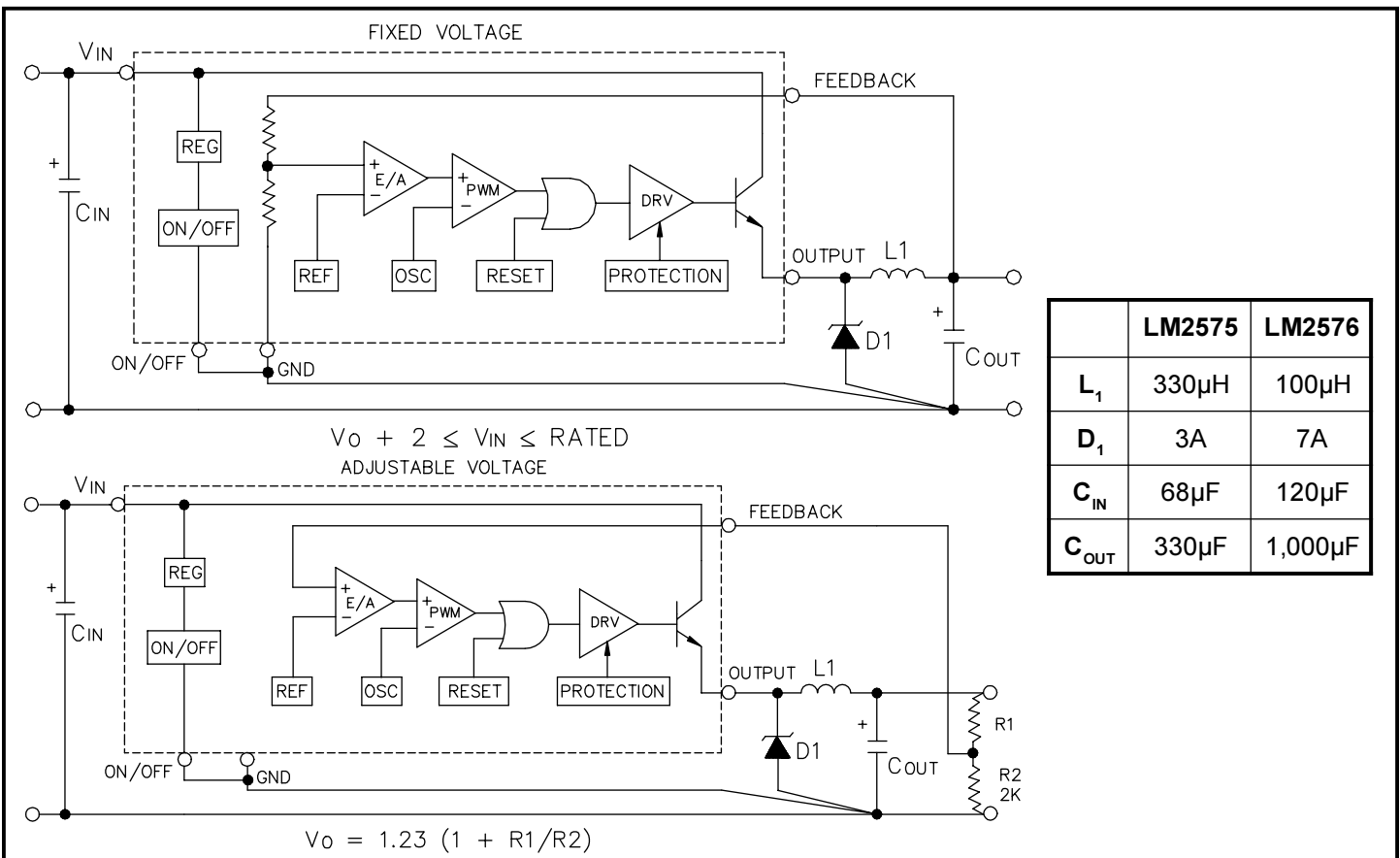

## Absolute Maximum Ratings

Parameter	Symbol	Maximum	Units
Input Voltage	$V_{IN}$	45	V
On/Off Pin Input Voltage	$V_{ON/OFF}$	$-0.3 \leq V_{ON/OFF} \leq V_{IN}$	V
Output Voltage to Common (Steady State)		-1	V
Power Dissipation	$P_D$	Internally Limited	W
Thermal Resistance Junction to Ambient TO-220 TO-263	$\theta_{JA}$	55 60	°C/W
Thermal Resistance Junction to Case TO-220 TO-263	$\theta_{JC}$	2.0 2.0	°C/W
Operating Junction Temperature Range	$T_J$	-40 to +125	°C
Storage Temperature Range	$T_{STG}$	-65 to +150	°C
Lead Temperature (Soldering) 10 Sec.	$T_{LEAD}$	300	°C
ESD Rating (Human Body Model)	$V_{ESD}$	2	kV

## Electrical Characteristics

Unless otherwise specified:  $V_{IN} = 12V$  for 3.3V, 5V and ADJ options and 25V for 12V option;  $V_{OUT} = 5V$  for ADJ option;  $T_A = 25^\circ C$ ;  $V_{IN}$  rated = 40V;  $I_O = 0.5$  to 3A (LM2576), 0.2 to 1A (LM2575). Values in **bold** apply over full operating temperature range.

Parameter	Symbol	Test Conditions	Min	Typ	Max	Units
Output Voltage	$V_O$	$I_O = 0.5A$	3.23	3.30	3.37	V
LM2576-3.3		8V to $V_{IN}$ Rated	3.20		3.40	
			<b>3.14</b>		<b>3.47</b>	
Output Voltage	$V_O$	$I_O = 0.5A$	4.90	5.00	5.10	V
LM2576-5		8V to $V_{IN}$ Rated	4.85		5.15	
			<b>4.75</b>		<b>5.25</b>	
Output Voltage	$V_O$	$I_O = 0.5A$	11.76	12.00	12.24	V
LM2576-12		15V to $V_{IN}$ Rated	11.52		12.48	
			<b>11.40</b>		<b>12.60</b>	
Feedback Voltage	$V_{FB}$	$I_O = 0.5A$	1.217	1.230	1.243	V
LM2576-ADJ, $V_O = 5V$		8V to $V_{IN}$ Rated	1.193		1.267	
			<b>1.180</b>		<b>1.280</b>	
Feedback Bias Current	$I_B$	$V_{IN} = 12V, I_O = 0.5A$		50	100	nA
LM2576-ADJ					<b>500</b>	

## Electrical Characteristics (Cont.)

Unless otherwise specified:  $V_{IN} = 12V$  for 3.3V, 5V and ADJ options and 25V for 12V option;  $V_{OUT} = 5V$  for ADJ option;  $T_A = 25^\circ C$ ;  $V_{IN}$  rated = 40V;  $I_O = 0.5$  to 3A (LM2576), 0.2 to 1A (LM2575). Values in **bold** apply over full operating temperature range.

Parameter	Symbol	Test Conditions	Min	Typ	Max	Units
Output Voltage LM2575-3.3	$V_O$	$I_O = 0.2A$	3.23	3.30	3.37	V
		8V to $V_{IN}$ Rated	3.20		3.40	
			<b>3.14</b>		<b>3.47</b>	
Output Voltage LM2575-5	$V_O$	$I_O = 0.2A$	4.90	5.00	5.10	V
		8V to $V_{IN}$ Rated	4.85		5.15	
			<b>4.75</b>		<b>5.25</b>	
Output Voltage LM2575-12	$V_O$	$I_O = 0.2A$	11.76	12.00	12.24	V
		15V to $V_{IN}$ Rated	11.52		12.48	
			<b>11.40</b>		<b>12.60</b>	
Feedback Voltage LM2575-ADJ, $V_O = 5V$	$V_{FB}$	$I_O = 0.2A$	1.217	1.230	1.243	V
		8V to $V_{IN}$ Rated	1.193		1.267	
			<b>1.180</b>		<b>1.280</b>	
Feedback Bias Current LM2575-ADJ	$I_B$	$V_{IN} = 12V, I_O = 0.2A$		50	100	nA
			<b>500</b>			
Efficiency/Option 3.3V 5V 12V ADJ, $V_O = 5V$	$\eta$	$V_{IN} = 12V, I_O = 1A$ (LM2575, 3A for LM2576)		77		%
				82		
		$V_{IN} = 15V, I_O = 1A$ (LM2575, 3A for LM2576)		88		
			$V_{IN} = 12V, I_O = 1A$ (LM2575, 3A for LM2576)		82	
Switching Frequency	$f_{SX}$		47	52	58	kHz
			<b>43</b>		<b>62</b>	
Saturation Voltage <sup>(1)</sup>	$V_{SAT}$	LM2575, $I_O = 1A$		<b>0.9</b>	<b>1.2</b>	V
		LM2576, $I_O = 3A$		<b>0.9</b>	<b>1.4</b>	
Max. Duty Cycle (On) <sup>(3)</sup>	DC		93	98		%
Peak Current LM2575 <sup>(1)</sup>	$I_{CL}$		1.7	2.2	3.0	A
			<b>1.3</b>		<b>3.2</b>	
Peak Current LM2576 <sup>(1)</sup>	$I_{CL}$		4.2	5.8	6.9	A
			<b>3.5</b>		<b>7.5</b>	

## Electrical Characteristics (Cont.)

Unless otherwise specified:  $V_{IN} = 12V$  for 3.3V, 5V and ADJ options and 25V for 12V option;  $V_{OUT} = 5V$  for ADJ option;  $T_A = 25^\circ C$ ;  $V_{IN}$  rated = 40V;  $I_O = 0.5$  to 3A (LM2576), 0.2 to 1A (LM2575). Values in **bold** apply over full operating temperature range.

Parameter	Symbol	Test Conditions	Min	Typ	Max	Units
Output Leakage Current <sup>(2)</sup>	$I_L$	$V_{IN} = V_{IN}$ Rated			2	mA
Output = 0V				7.5	30	
Output = -1V						
Quiescent Current <sup>(2)</sup>	$I_Q$			5	10	mA
					<b>12</b>	
Standby Quiescent Current (On/Off Pin = 5V)	$I_{STBY}$			50		$\mu A$
On/Off Pin Logic Input Level	$V_{IH}$		2.2	1.4		V
			<b>2.4</b>			
	$V_{IL}$			1.2	1.0	V
					<b>0.8</b>	
On/Off Pin Input Current	$I_{IH}$	$V_{ON/OFF} = 5V$ (Off)		12	30	$\mu A$
	$I_{IL}$	$V_{ON/OFF} = 0V$ (On)		0	10	

### Notes:

- (1) Output sourcing current, resistive load, no inductor or capacitor.
- (2) Feedback =  $V_O + 1.0V$ .
- (3) Feedback = 0V.

## Pin Configurations

LM2575, LM2576	
Pin	Function
1	$V_{IN}$
2	OUTPUT
3	COMMON
4	FEEDBACK
5	ON/OFF
TAB is COMMON	

## Ordering Information

(1) -XX = Voltage Option. Available voltages are 3.3V (-3.3), 5V (-5.0), 12V (-12), and ADJ (-ADJ), which is adjustable between 1.23V and 35V.

## Block Diagram

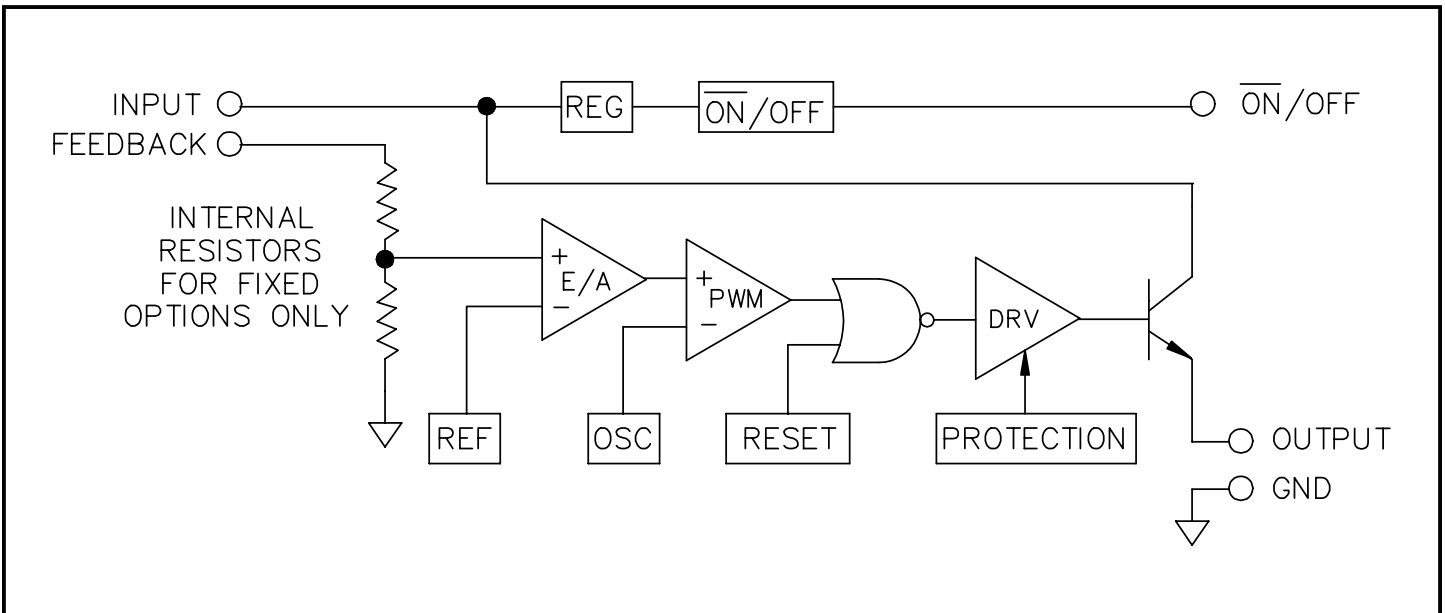

## Typical Characteristics - LM2575

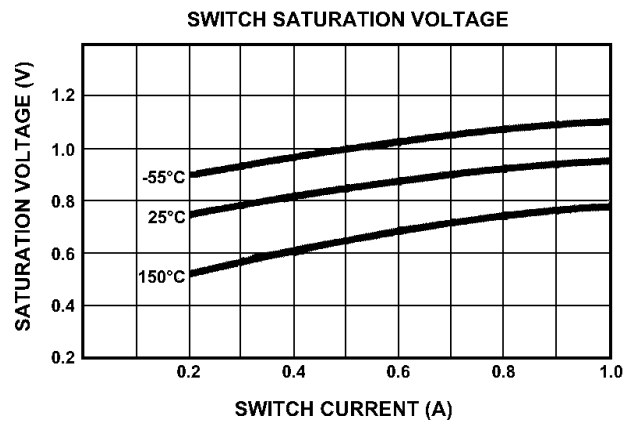
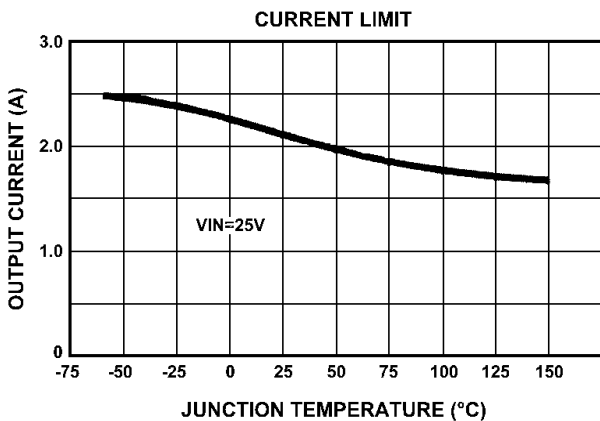
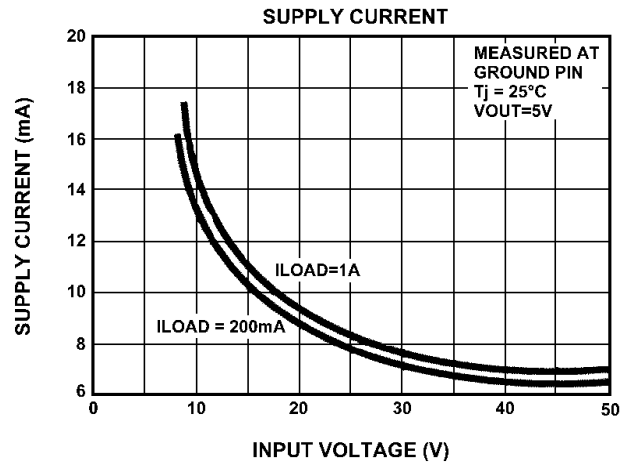
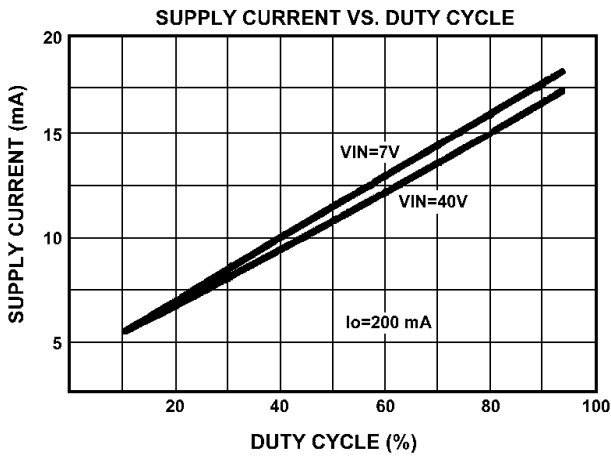
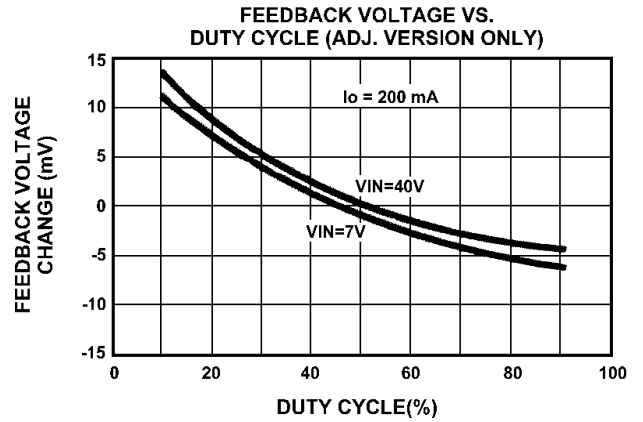
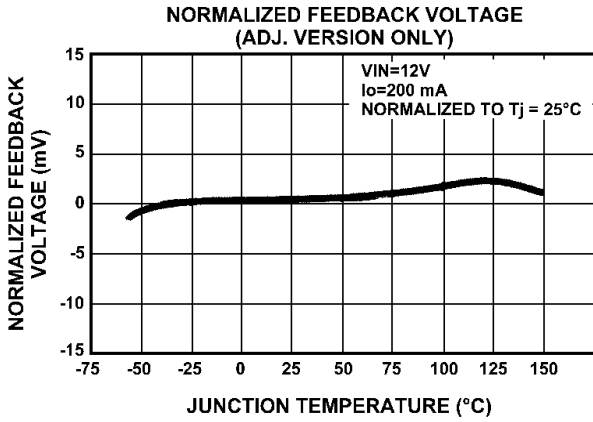

## Typical Characteristics - LM2575 (Cont.)

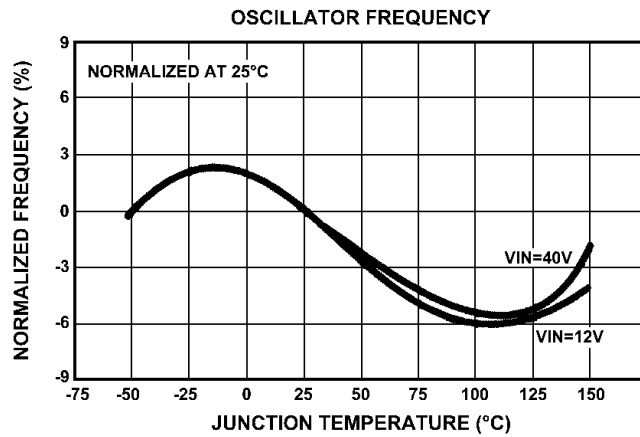
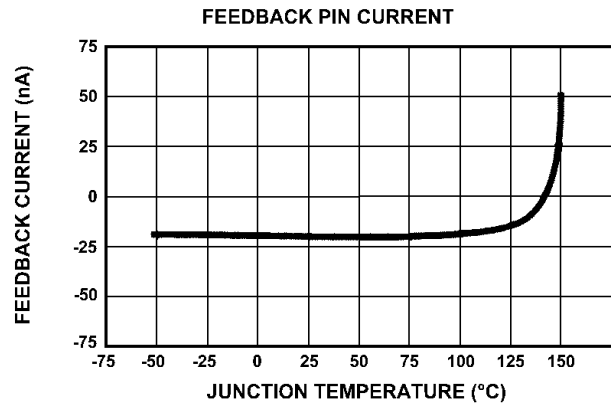
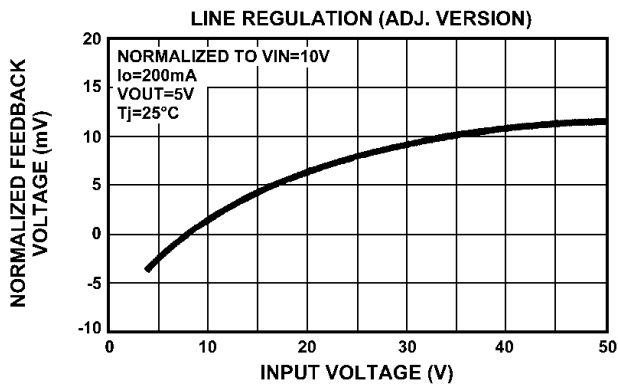
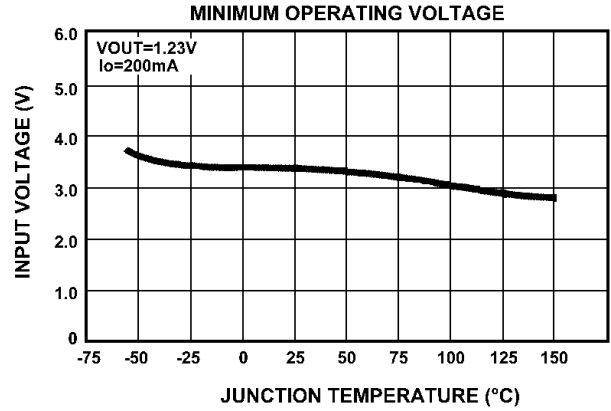
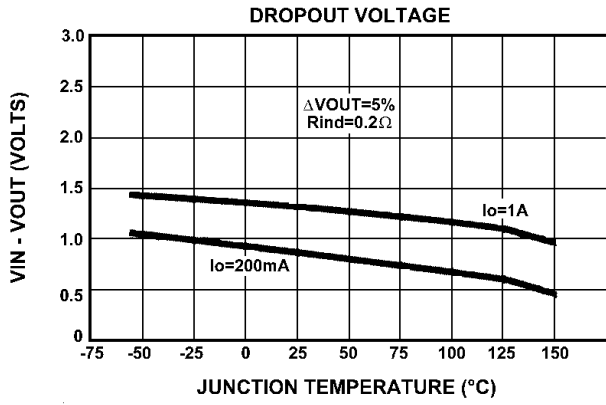

## Typical Characteristics - LM2575 (Cont.)

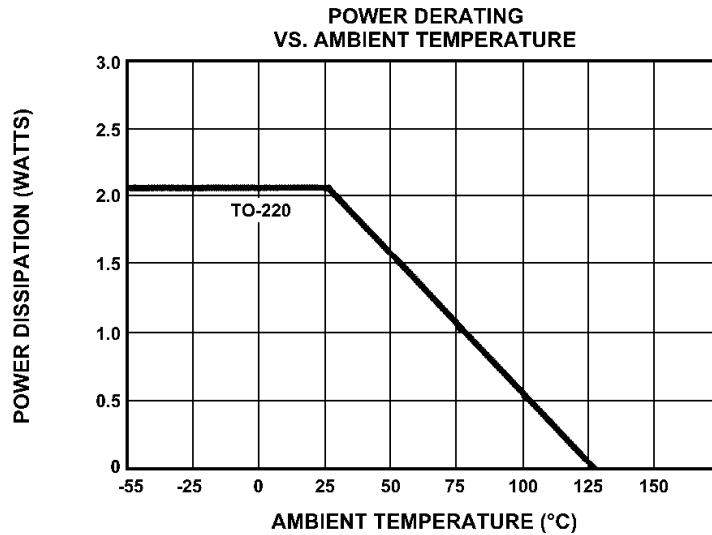
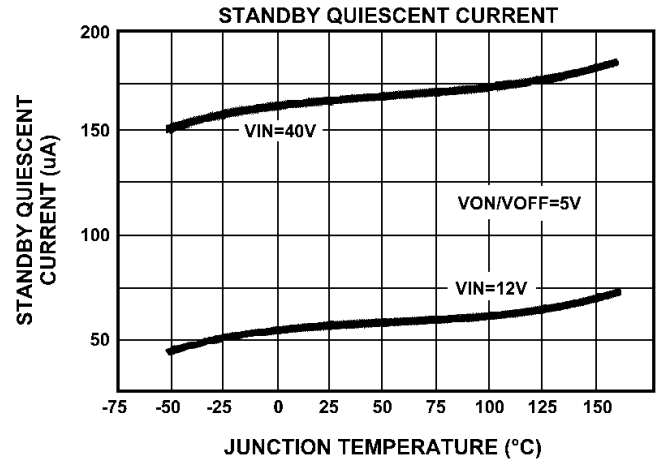
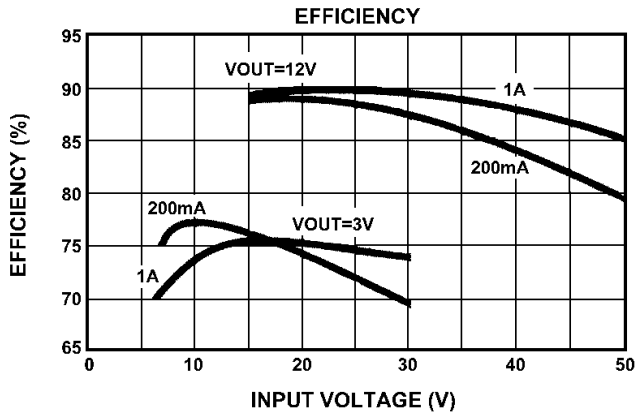



## Typical Characteristics - LM2576

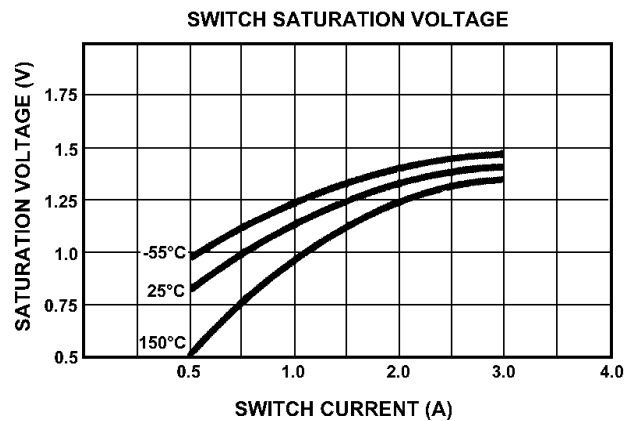
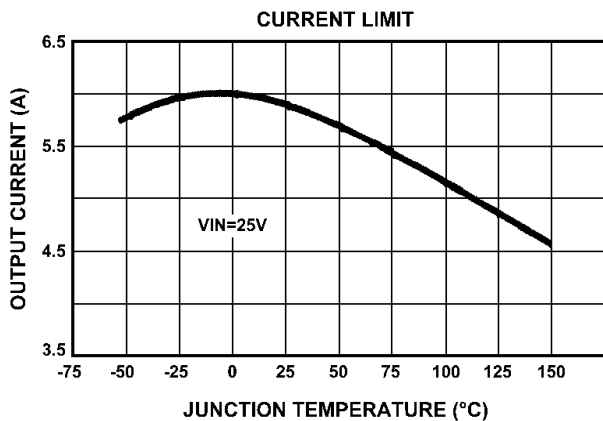
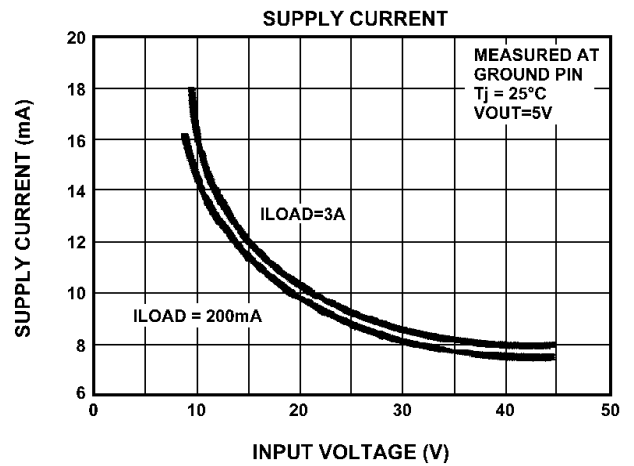
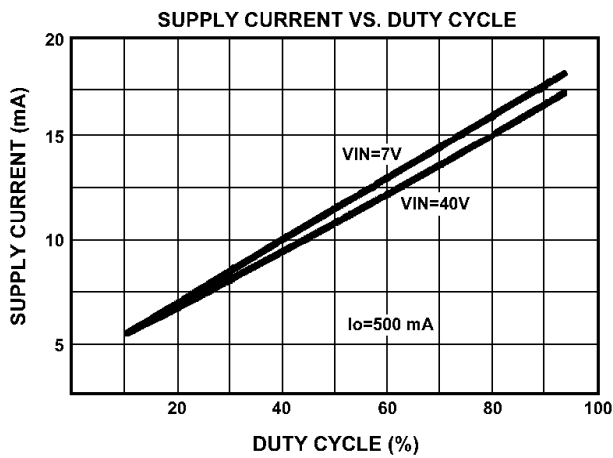
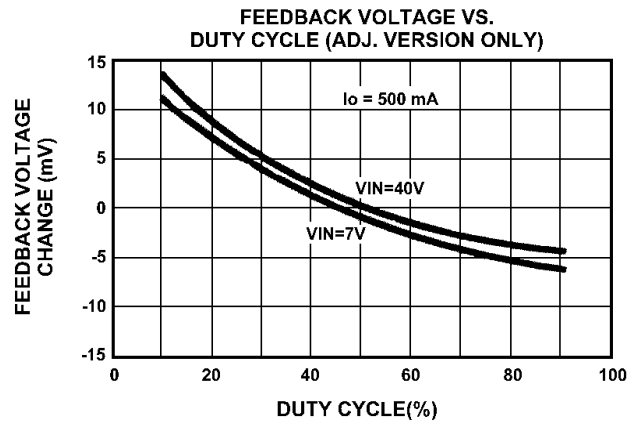
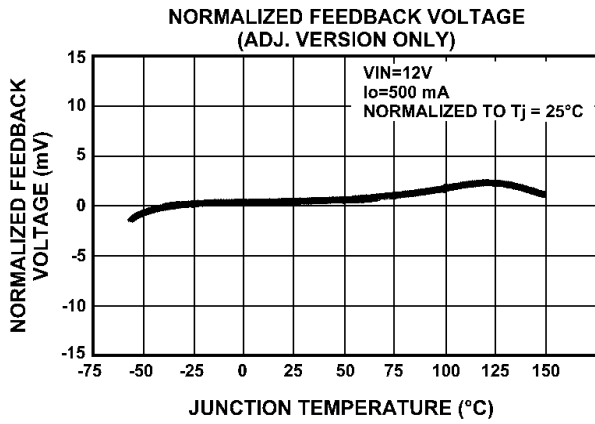

## Typical Characteristics - LM2576 (Cont.)

### DROPOUT VOLTAGE

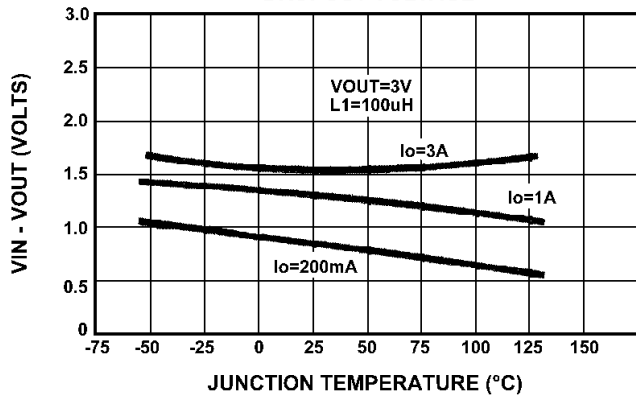

### MINIMUM OPERATING VOLTAGE

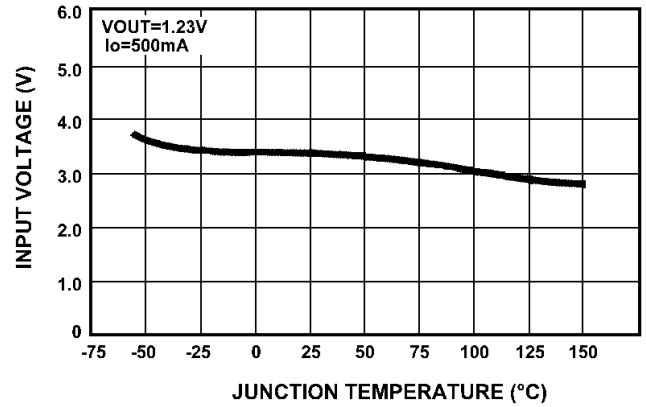

### LINE REGULATION (ADJ. VERSION)

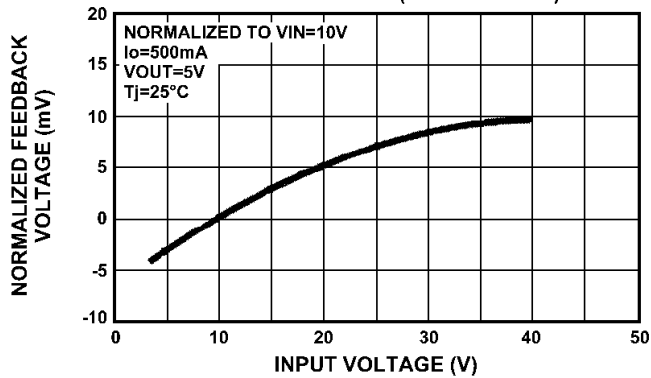

### FEEDBACK PIN CURRENT

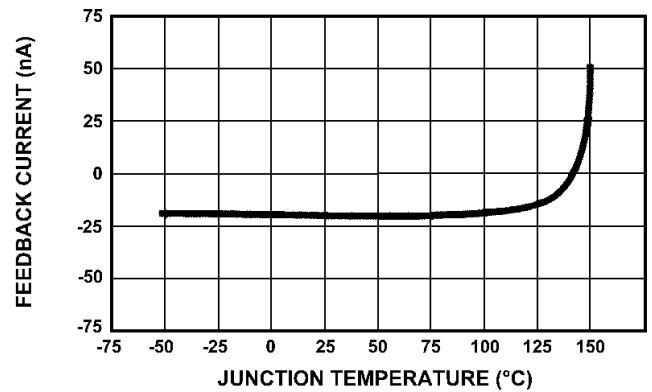

### OSCILLATOR FREQUENCY

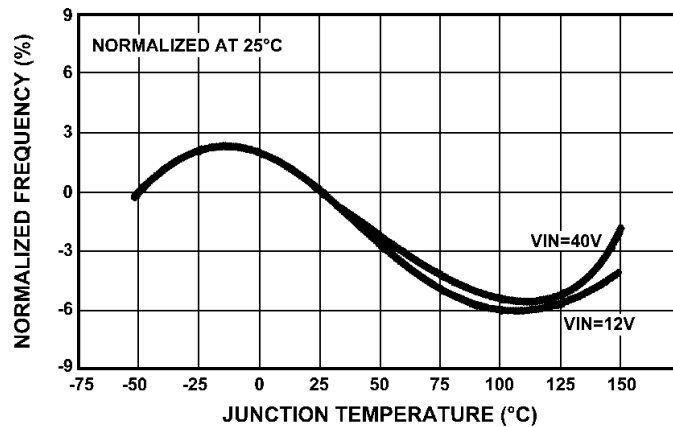

## Typical Characteristics - LM2576 (Cont.)

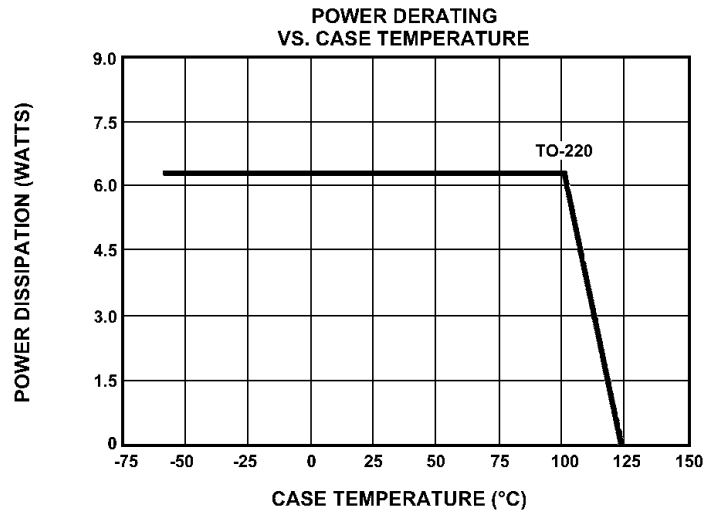
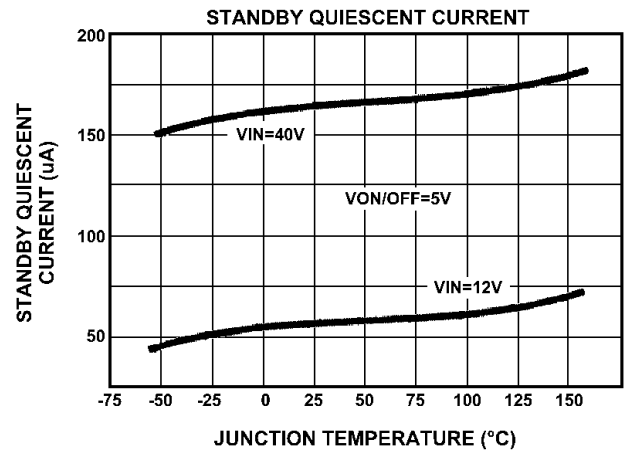
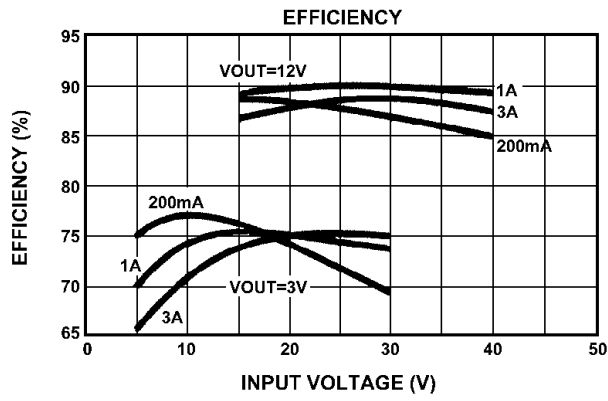

## Outline Drawing - TO-220-5

DIM <sup>N</sup>	INCHES		MM		NOTE
	MIN	MAX	MIN	MAX	
A	.560	.650	14.22	16.51	—
B	.380	.420	9.65	10.67	—
D	.230	.260	5.84	6.60	—
E	.100	.135	2.54	3.43	—
F	.263	.273	6.68	6.94	—
G	.062	.072	1.57	1.83	—
H	.025	.040	.63	1.02	—
J	.140	.190	3.55	4.83	—
K	.045	.055	1.14	1.40	—
L	.540	.560	13.72	14.22	—
M	.014	.022	.35	.56	—
N	.080	.120	2.03	3.05	—
φX	.139	.161	3.53	4.09	—

JEDEC TO-220

## Outline Drawing - TO-263-5

DIM <sup>N</sup>	INCHES		MM		NOTE
	MIN	MAX	MIN	MAX	
A	.380	.405	9.65	10.29	—
B	.575	.625	14.60	15.88	—
C	.325	.380	8.25	9.66	—
D	—	.055	—	1.40	—
E	.020	.039	.50	.99	—
F	.060	.072	1.52	1.83	—
G	.045	.055	1.14	1.40	—
H	.160	.190	4.06	4.83	—
J	.090	.110	2.28	2.80	—
K	.018	.029	.457	.736	—

JEDEC TO-263

## Minimum Land Pattern - TO-263-5

NOTE: ALL DIMENSIONS ARE IN INCHES

## X-ON Electronics

Largest Supplier of Electrical and Electronic Components

*Click to view similar products for [Switching Controllers](#) category:*

*Click to view products by [SLKORMICRO](#) manufacturer:*

Other Similar products are found below :

[AP3844CMTR-E1](#) [NCP1218AD65R2G](#) [NCP1234AD100R2G](#) [NCP1244BD065R2G](#) [NCP1336ADR2G](#) [NCP6153MNTWG](#)  
[NCP81005MNTWG](#) [NCP81101BMNTXG](#) [NCP81205MNTXG](#) [SJ6522AG](#) [SJE6600](#) [AZ7500BMTR-E1](#) [IR35215MTRPBF](#) [SG3845DM](#)  
[NCP4202MNR2G](#) [NCP4204MNTXG](#) [NCP6132AMNR2G](#) [NCP81102MNTXG](#) [NCP81141MNTXG](#) [NCP81203MNTXG](#) [NCP81206MNTXG](#)  
[NX2155HCUPTR](#) [UBA2051C](#) [IR35201MTRPBF](#) [FSL4110LRLX](#) [NCP1015ST65T3G](#) [NCP1240AD065R2G](#) [NCP1240FD065R2G](#)  
[NCP1336BDR2G](#) [NCP1361BABAYSNT1G](#) [NCP1230P100G](#) [NX2124CSTR](#) [SG2845M](#) [NCP1366BABAYDR2G](#) [NCP81101MNTXG](#)  
[TEA19362T/1J](#) [NCP81174NMNTXG](#) [NCP4308DMTTWG](#) [NCP4308DMNTWG](#) [NCP4308AMTTWG](#) [NCP1366AABAYDR2G](#)  
[NCP1256ASN65T1G](#) [NCP1251FSN65T1G](#) [NCP1246BLD065R2G](#) [MB39A136PFT-G-BND-ERE1](#) [NCP1256BSN100T1G](#) [LV5768V-A-](#)  
[TLM-E](#) [NCP1365AABCYDR2G](#) [IR35204MTRPBF](#) [MCP1633T-E/MG](#)