

## Schottky Barrier Rectifiers

### Features

- Low Forward Voltage Drop
- Guard Ring Construction for Transient Protection
- High Conductance
- Also Available in Lead Free Version

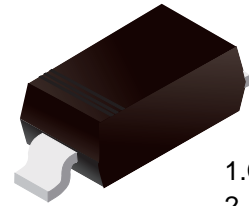

1.Cathode  
2.Anode

### Simplified outline(SOD-123)



### Maximum Ratings and Electrical characteristics

Ratings at 25 °C ambient temperature unless otherwise specified.

Parameter	Symbols	MBR0520W	MBR0530W	MBR0540W	Units
Peak Repetitive Reverse Voltage	$V_{RRM}$	20	30	40	V
RMS reverse voltage reverse voltage (DC)	$V_{RMS}$	14	21	28	V
Maximum DC Blocking Voltage	$V_{DC}$	20	30	40	V
Maximum Average Forward Current at Ta=25°C	$I_O$	0.5			A
Peak Forward Surge Current, 8.3ms single half sine-wave superimposed on rated load (JEDEC method)	$I_{FSM}$	25			A
Maximum Instantaneous Forward Voltage	$I_F=0.1A$	0.330	0.375	–	V
	$I_F=0.5A$	0.390	0.430	0.510	
	$I_F=1A$	–	–	0.620	
Reverse current	$V_R=10V$	75	–	–	uA
	$V_R=15V$	–	20	–	
	$V_R=20V$	250	–	10	
	$V_R=30V$	–	130	–	
	$V_R=40V$	–	–	20	
Thermal Resistance, Junction to Ambient Air	$R_{\theta JA}$	200			°C/W
Junction temperature	$T_j$	-55 ~ +125			°C
Storage temperature	$T_{stg}$	-55 ~ +150			°C

### Marking

Type	MBR0520W	MBR0530W	MBR0540W
Marking	B2	B3	B4

**Fig.1 Forward Current Derating Curve**

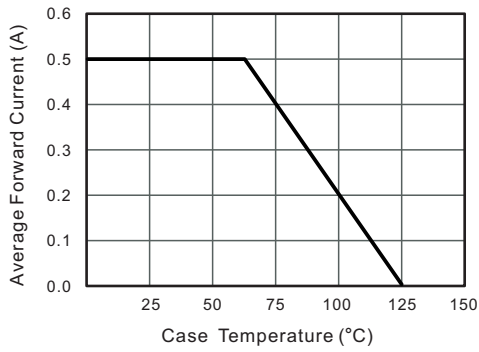

**Fig.2 Typical Reverse Characteristics**

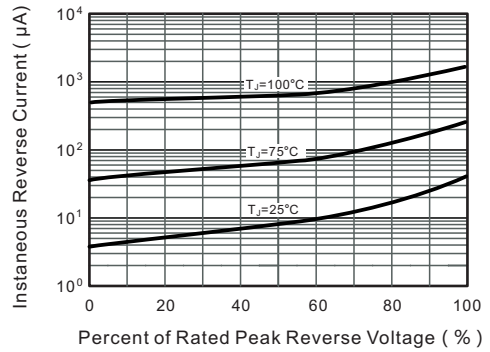

**Fig.3 TYPICAL FORWARD VOLTAGE**

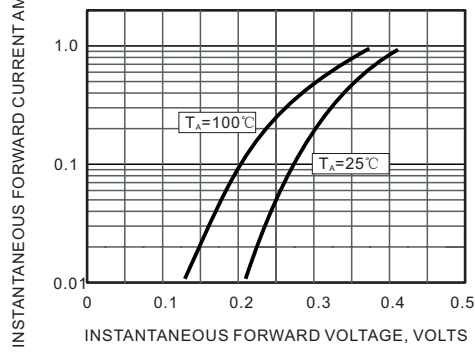

**Fig.4 Typical Junction Capacitance**

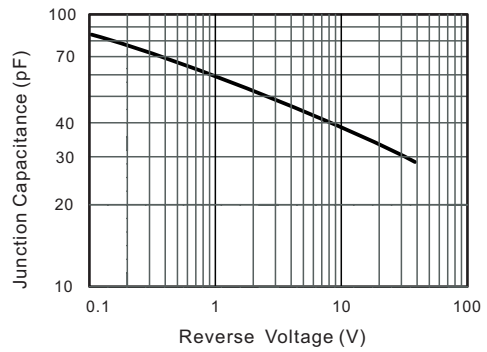

**Fig.5 Maximum Non-Repetitive Peak Forward Surge Current**

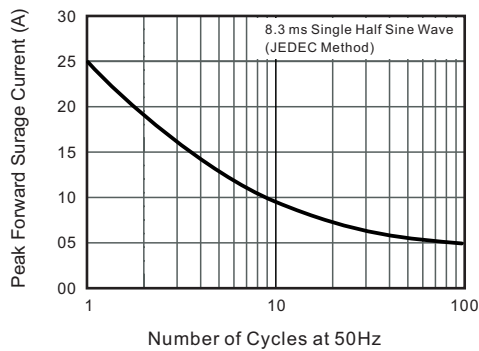

**Fig.6 Typical Transient Thermal Impedance**

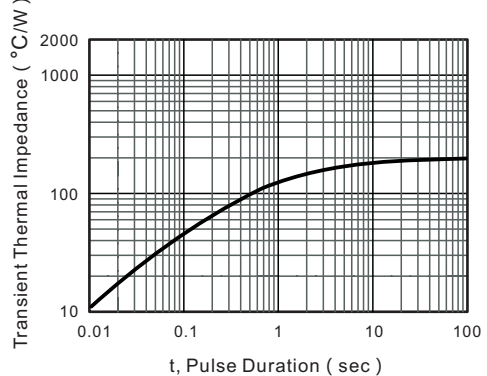

## ■ SOD-123

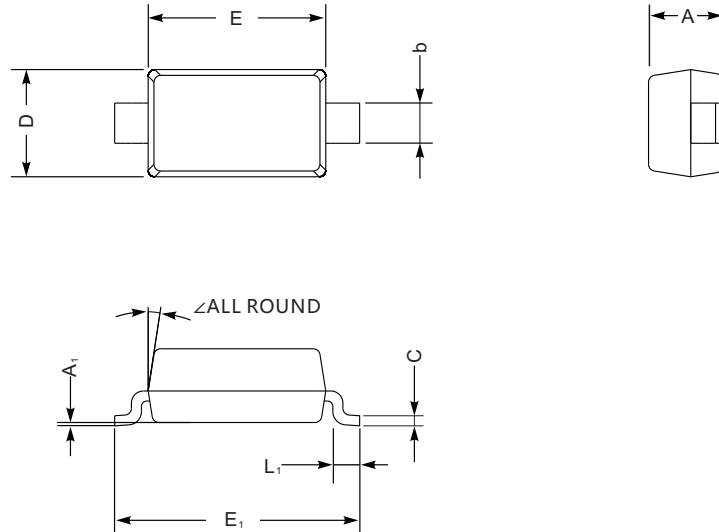

SOD-123 mechanical data

UNIT		A	C	D	E	E <sub>1</sub>	L <sub>1</sub>	b	A <sub>1</sub>	∠
mm	max	1.3	0.22	1.8	2.8	3.9	0.45	0.7	0.2	9°
	min	0.9	0.09	1.5	2.5	3.6	0.25	0.5	—	
mil	max	51	8.7	71	110	154	18	28	8	
	min	35	3.5	59	98	142	10	20	—	

## ■ The recommended mounting pad size

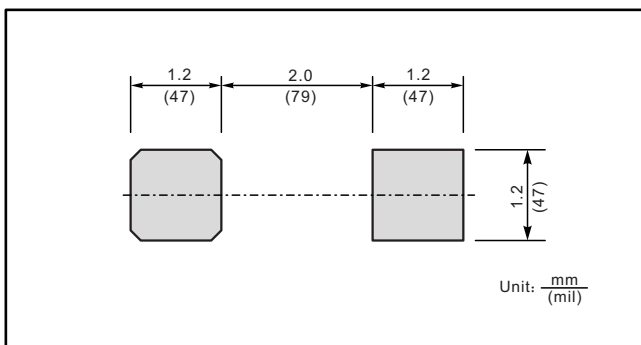

## X-ON Electronics

Largest Supplier of Electrical and Electronic Components

*Click to view similar products for [Schottky Diodes & Rectifiers](#) category:*

*Click to view products by [SLKORMICRO](#) manufacturer:*

Other Similar products are found below :

[MA4E2039](#) [MA4E2508M-1112](#) [MBR1545CT](#) [MMBD301M3T5G](#) [RB160M-50TR](#) [D83C](#) [BAS16E6433HTMA1](#) [BAT 54-02LRH E6327](#)  
[NRVBAF360T3G](#) [NSR05F40QNXT5G](#) [NTE555](#) [JANS1N6640](#) [SK310-T](#) [SK34B-TP](#) [SS3003CH-TL-E](#) [GA01SHT18](#)  
[CRS10I30A\(TE85L,QM](#) [MA4E2501L-1290](#) [MBRA140TRPBF](#) [MBRB30H30CT-1G](#) [BAT 15-04R E6152](#) [JANTX1N5712-1](#) [DMJ3940-000](#)  
[SB007-03C-TB-E](#) [SK33B-TP](#) [NRVBB20100CTT4G](#) [NRVBM120LT1G](#) [NTSB30U100CT-1G](#) [VS-6CWQ10FNHM3](#) [CRG04\(T5L,TEMQ\)](#)  
[ACDBA1100LR-HF](#) [ACDBA1200-HF](#) [ACDBA240-HF](#) [ACDBA3100-HF](#) [CDBQC0530L-HF](#) [CDBQC0240LR-HF](#) [ACDBA260LR-HF](#)  
[ACDBA1100-HF](#) [MA4E2502L-1246](#) [10BQ015-M3/5BT](#) [NRVBM120ET1G](#) [CRS08TE85LQM](#) [PMAD1108-LF](#) [B120Q-13-F](#) [1N5819T-G](#)  
[B0530WSQ-7-F](#) [PDS1040Q-13](#) [B160BQ-13-F](#) [SDM05U20CSP-7](#) [B140S1F-7](#)