

MMBD4148 / SE / CC / CA

Silicon Epitaxial Planar Switching Diode

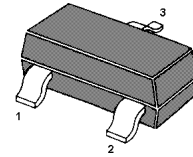
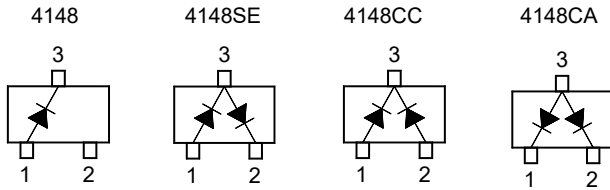

MMBD4148 Marking Code: **5D**
 MMBD4148SE Marking Code: **A7**
 MMBD4148CC Marking Code: **A4**
 MMBD4148CA Marking Code: **A1**
 SOT-23 Plastic Package

Absolute Maximum Ratings ($T_a = 25^\circ\text{C}$)

Parameter	Symbol	Value	Unit
Maximum Repetitive Reverse Voltage	V_{RRM}	100	V
Reverse Voltage	V_R	75	V
Average Rectified Forward Current	$I_{F(AV)}$	200	mA
DC Forward Current	I_{FM}	600	mA
Recurrent Peak Forward Current	I_{FRM}	700	mA
Non-repetitive Peak Forward Surge Current	I_{FSM}	1 2	A
		at $t = 1\text{ s}$ at $t = 1\ \mu\text{s}$	
Total Device Dissipation	P_{tot}	350	mW
Operating Junction Temperature	T_j	150	$^\circ\text{C}$
Storage Temperature Range	T_{stg}	- 55 to + 150	$^\circ\text{C}$

Characteristics at $T_a = 25^\circ\text{C}$

Parameter	Symbol	Min.	Max.	Unit
Forward Voltage at $I_F = 10\text{ mA}$	V_F	-	1	V
Reverse Breakdown Voltage at $I_R = 100\ \mu\text{A}$ at $I_R = 5\ \mu\text{A}$	$V_{(BR)R}$	100 75	- -	V
Reverse Current at $V_R = 20\text{ V}$ at $V_R = 75\text{ V}$ at $V_R = 20\text{ V}, T_a = 150^\circ\text{C}$	I_R	- - -	25 5 50	nA μA μA
Reverse Recovery Time at $I_F = 10\text{ mA}, V_R = 6\text{ V}, I_{RR} = 0.1 \times I_R, R_L = 100\ \Omega$	t_{rr}	-	4	ns
Total Capacitance at $V_R = 0\text{ V}, f = 1\text{ MHz}$	C_{tot}	-	4	pF

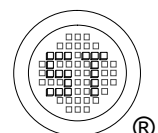

Electrical Characteristics Curves

Fig 1. Power Dissipation vs. Temperature

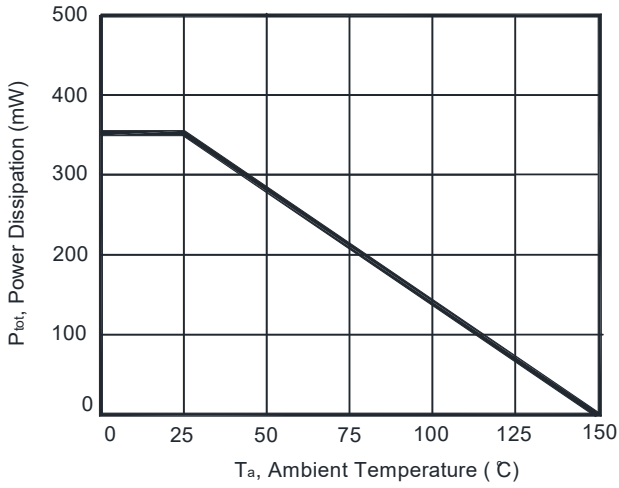

Fig 2. Total Capacitance vs. Reverse Voltage

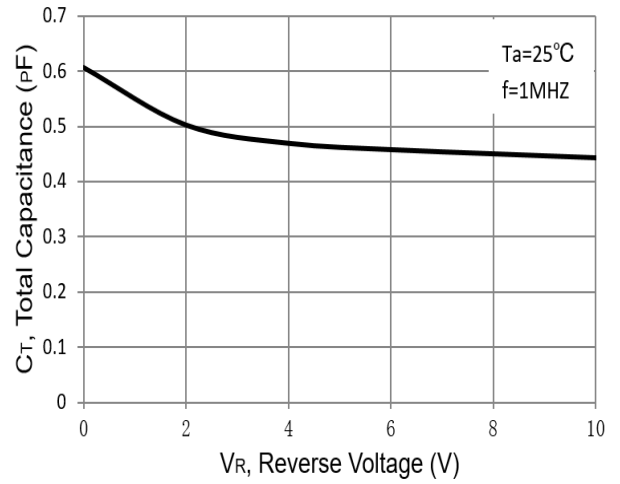

Fig 3. Reverse Current vs. Reverse Voltage

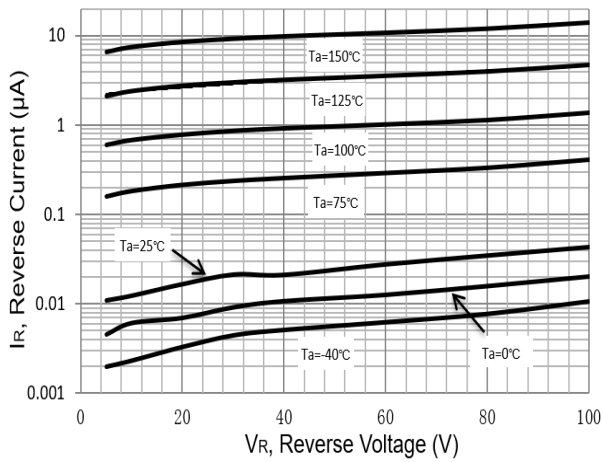
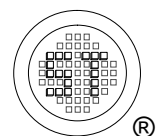
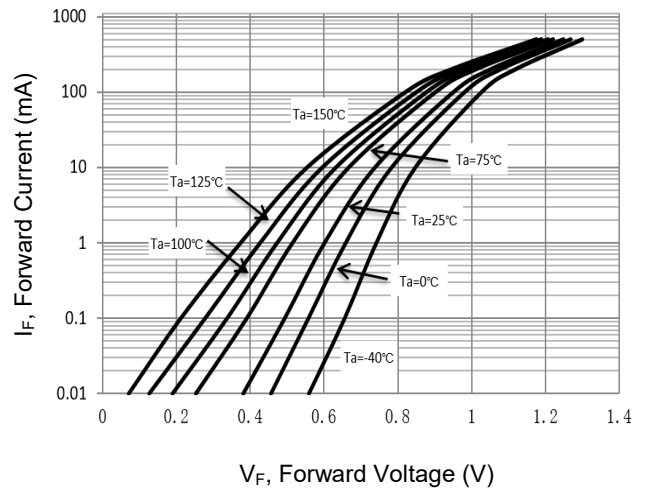
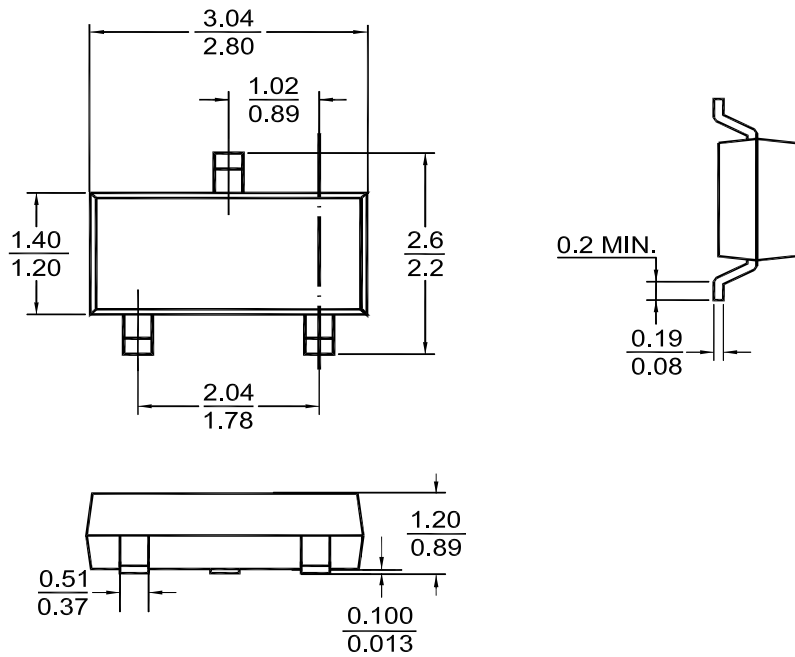

Fig 4. Forward Characteristics



Package Outline (Dimensions in mm)

SOT-23



Recommended Soldering Footprint

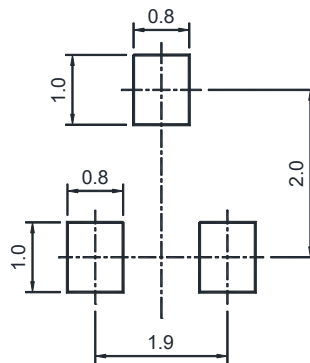

Packing information

Package	Tape Width (mm)	Pitch		Reel Size		Per Reel Packing Quantity
		mm	inch	mm	inch	
SOT-23	8	4 ± 0.1	0.157 ± 0.004	178	7	3,000

Marking information

- " ** " = Part No.
- " YM " = Date Code Marking
- " Y " = Year
- " M " = Month
- Font type: Arial

