

SILICON PLANAR ZENER DIODES

FEATURES

- Planar Die construction
- 350mW Power Dissipation
- Zener Voltages from 2.4V~51V
- Ideally Suited for Automated Assembly Processes

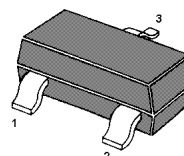

1.ANODE 3.CATHODE
SOT-23 Plastic Package

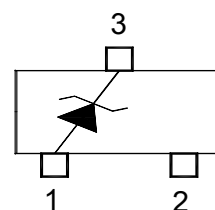

Absolute Maximum Ratings ($T_a = 25\text{ }^\circ\text{C}$)

Parameter	Symbol	Value	Unit
Power Dissipation	P_D	350	mW
Thermal Resistance, Junction to Ambient	$R_{\theta JA}$	357	$^\circ\text{C/W}$
Junction Temperature	T_j	150	$^\circ\text{C}$
Storage Temperature Range	T_{stg}	- 55 to + 150	$^\circ\text{C}$

Characteristics $T_a = 25\text{ }^\circ\text{C}$ ($V_F = 0.9\text{ V}$ Maximum at $I_F = 10\text{ mA}$)

Type	Marking Code	Zener Voltage Range ¹⁾			Max. Dynamic Resistance				Max. Reverse Current	
		V_{znom}	V_{ZT}	at I_{ZT}	Z_{ZT}	at I_{ZT}	Z_{ZK}	at I_{ZK}	I_R	at V_R
		V	V	mA	Ω	mA	Ω	mA	μA	V
MMBZ5221B	Y0	2.4	2.28...2.52	20	30	20	1200	0.25	100	1
MMBZ5223B	Z0	2.7	2.57...2.84	20	30	20	1300	0.25	75	1
MMBZ5225B	AA	3	2.85...3.15	20	30	20	1600	0.25	50	1
MMBZ5226B	AB	3.3	3.14...3.47	20	28	20	1600	0.25	25	1
MMBZ5227B	AC	3.6	3.42...3.78	20	24	20	1700	0.25	15	1
MMBZ5228B	AD	3.9	3.71...4.1	20	23	20	1900	0.25	10	1
MMBZ5229B	AE	4.3	4.09...4.52	20	22	20	2000	0.25	5	1
MMBZ5230B	AF	4.7	4.47...4.94	20	19	20	1900	0.25	5	2
MMBZ5231B	AH	5.1	4.85...5.36	20	17	20	1600	0.25	5	2
MMBZ5232B	AJ	5.6	5.32...5.88	20	11	20	1600	0.25	5	3
MMBZ5233B	AK	6	5.7...6.3	20	7	20	1600	0.25	5	3.5
MMBZ5234B	AM	6.2	5.89...6.51	20	7	20	1000	0.25	5	4
MMBZ5235B	AN	6.8	6.46...7.14	20	5	20	750	0.25	3	5
MMBZ5236B	AP	7.5	7.13...7.88	20	6	20	500	0.25	3	6
MMBZ5237B	AR	8.2	7.79...8.61	20	8	20	500	0.25	3	6.5
MMBZ5239B	AY	9.1	8.65...9.56	20	10	20	600	0.25	3	7
MMBZ5240B	AZ	10	9.5...10.5	20	17	20	600	0.25	3	8
MMBZ5241B	BA	11	10.45...11.55	20	22	20	600	0.25	2	8.4
MMBZ5242B	BB	12	11.4...12.6	20	30	20	600	0.25	1	9.1
MMBZ5243B	BC	13	12.35...13.65	9.5	13	9.5	600	0.25	0.5	9.9
MMBZ5245B	BE	15	14.25...15.75	8.5	16	8.5	600	0.25	0.1	11
MMBZ5246B	BF	16	15.2...16.8	7.8	17	7.8	600	0.25	0.1	12
MMBZ5247B	BH	17	16.15...17.85	7.4	19	7.4	600	0.25	0.1	13
MMBZ5248B	BJ	18	17.1...18.9	7	21	7	600	0.25	0.1	14
MMBZ5249B	BK	19	18.05...19.95	6.6	23	6.6	600	0.25	0.1	14
MMBZ5250B	BM	20	19...21	6.2	25	6.2	600	0.25	0.1	15
MMBZ5251B	BN	22	20.9...23.1	5.6	29	5.6	600	0.25	0.1	17
MMBZ5252B	BP	24	22.8...25.2	5.2	33	5.2	600	0.25	0.1	18
MMBZ5253B	BR	25	23.75...26.25	5	35	5	600	0.25	0.1	19
MMBZ5254B	BX	27	25.65...28.35	4.6	41	4.6	600	0.25	0.1	21
MMBZ5256B	BZ	30	28.5...31.5	4.2	49	4.2	600	0.25	0.1	23
MMBZ5257B	CA	33	31.35...34.65	3.8	58	3.8	700	0.25	0.1	25
MMBZ5258B	CB	36	34.2...37.8	3.4	70	3.4	700	0.25	0.1	27
MMBZ5259B	CC	39	37.05...40.95	3.2	80	3.2	800	0.25	0.1	30
MMBZ5260B	CD	43	40.85...45.15	3	93	3	800	0.25	0.1	33
MMBZ5261B	CE	47	44.65...49.35	2.7	105	2.7	1000	0.25	0.1	36
MMBZ5262B	CF	51	48.45...53.55	2.5	125	2.5	1100	0.25	0.1	39

¹⁾ Tested with pulses $t_p = 20\text{ ms}$.

Typical Characteristics

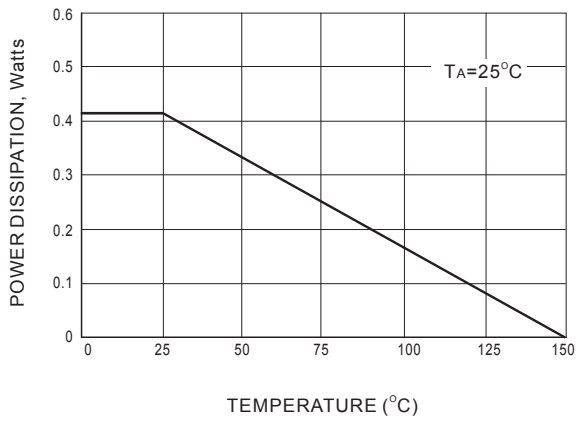

Fig.1 STEADY STATE POWER DERATING

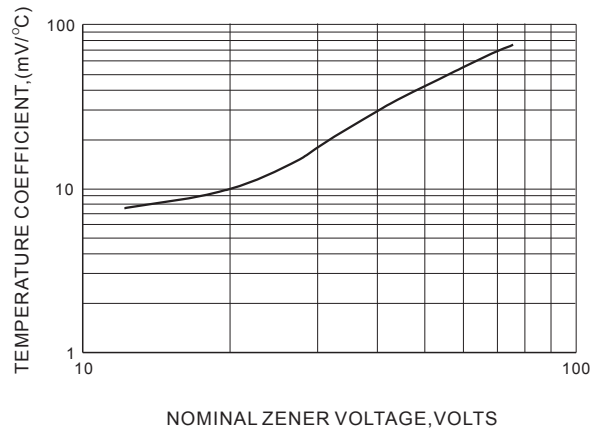

Fig.2 TEMPERATURE COEFFICIENTS

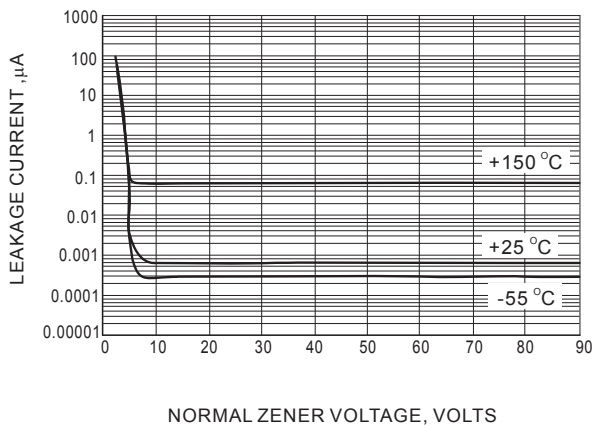

Fig.3 TYPICAL LEAKAGE CURRENT

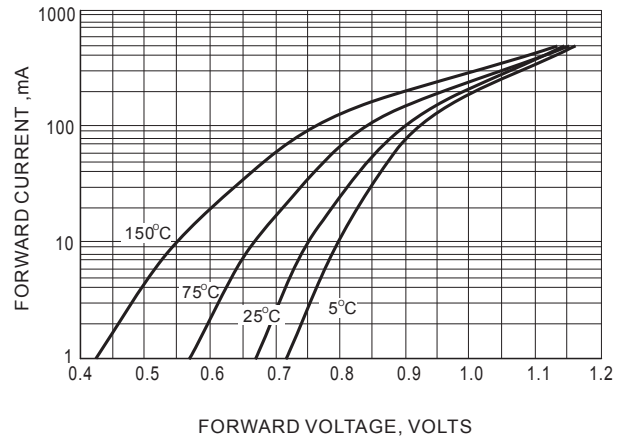
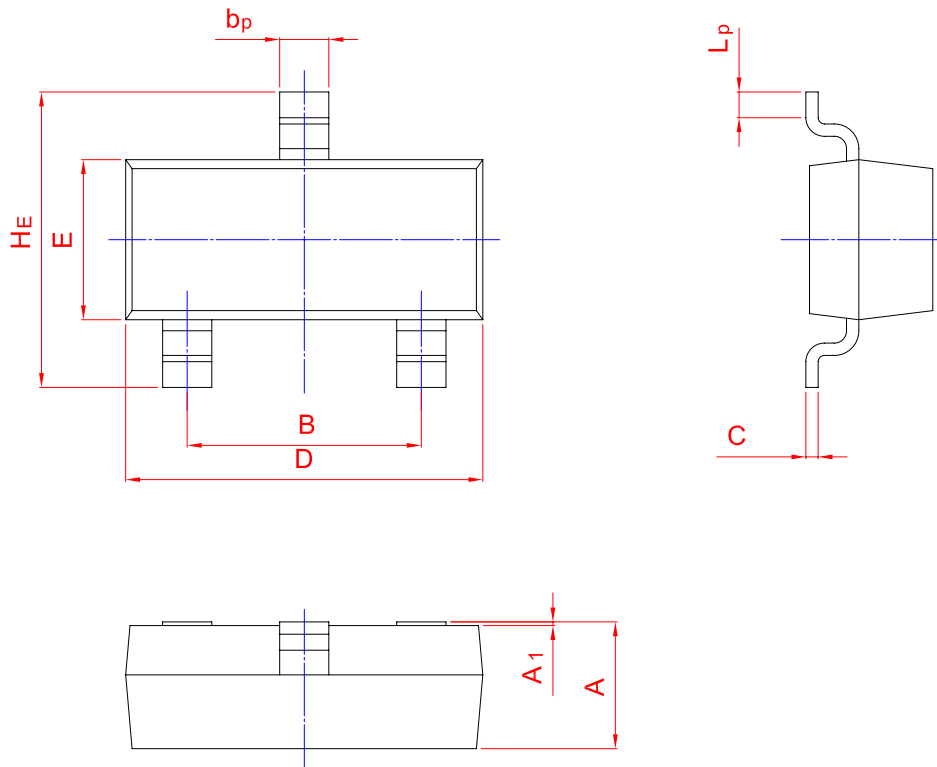
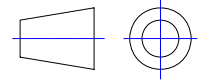

Fig.4 TYPICAL FORWARD VOLTAGE

PACKAGE OUTLINE

Plastic surface mounted package; 3 leads

SOT-23



UNIT	A	B	bp	C	D	E	HE	A1	Lp
mm	1.40	2.04	0.50	0.19	3.10	1.65	3.00	0.100	0.50
	0.95	1.78	0.35	0.08	2.70	1.20	2.20	0.013	0.20

X-ON Electronics

Largest Supplier of Electrical and Electronic Components

Click to view similar products for [Zener Diodes](#) category:

Click to view products by [SLKORMICRO](#) manufacturer:

Other Similar products are found below :

[RKZ13B2KG#P1](#) [RKZ5.6B2KJ#R1](#) [DL5234B](#) [EDZTE6113B](#) [1N4682](#) [1N4691](#) [1N4693](#) [1N4732A](#) [1N4736A](#) [1N4750A](#) [1N4759ARL](#)
[1N5241B](#) [1N5365B](#) [1N5369B](#) [1N747A](#) [1N959B](#) [1N964B](#) [1N966B](#) [1N968B](#) [1N972B](#) [NTE5121A](#) [NTE5147A](#) [NTE5152A](#) [NTE5155A](#)
[NTE5164A](#) [JANS1N4974US](#) [1N4692](#) [1N4700](#) [1N4702](#) [1N4704](#) [1N4711](#) [1N4714](#) [1N4737A](#) [1N4745ARL](#) [1N4752A](#) [1N4752ARL](#)
[1N4760ARL](#) [1N5221B](#) [1N5231B-TR](#) [1N5236B](#) [1N5241BTR](#) [1N5242BTR](#) [1N5350B](#) [1N5352B](#) [1N961BRR1](#) [1N964BRL](#) [RKZ5.1BKU#P6](#)
[3SMAJ5946B-TP](#) [3SMAJ5950B-TP](#) [3SMBJ5925B-TP](#)