

15.0A Surface Mount Trench Schottky Rectifier

■ Features

- Low forward voltage drop.
- Excellent high temperature stability.
- Fast switching capability.
- Suffix "G" indicates Halogen-free part, ex.CP10S45SG.
- Lead-free parts meet environmental standards of MIL-STD-19500 /228

■ Mechanical data

- Epoxy : UL94-V0 rated flame retardant.
- Case : Molded plastic, TO-277.
- Lead : Solder plated, solderable per MIL-STD-750, Method 2026.
- Polarity: Indicated by cathode band.
- Mounting Position : Any.
- Weight : Approximated 0.093 grams.

VOLTAGE RANGE 45 Volts

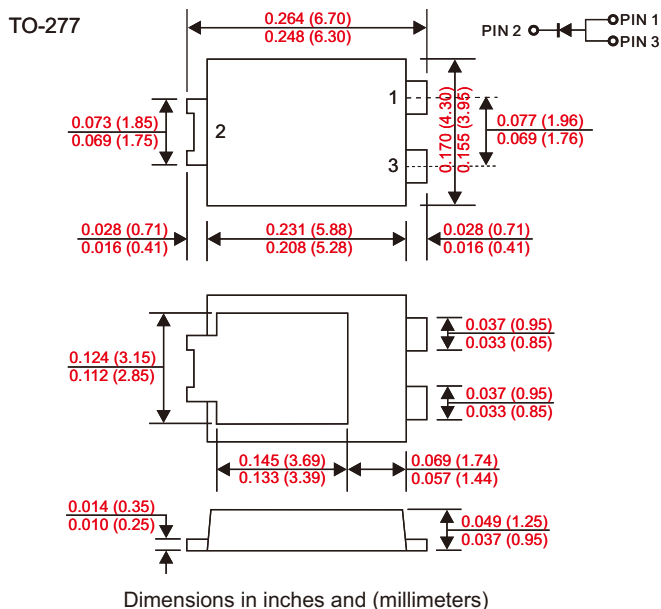
CURRENT 10.0 Ampere

MAXIMUM RATINGS AND ELECTRICAL CHARACTERISTICS

Rating 25°C ambient temperature unless otherwise specified.
 Single phase half wave, 60Hz, resistive or inductive load.
 For capacitive load, derate current by 20%.

TYPE NUMBER	SB1545L LOWVF	UNITS
Maximum Recurrent Peak Reverse Voltage	45	V
Maximum RMS Voltage	32	V
Maximum DC Blocking Voltage	45	V
Maximum Average Forward Rectified Current		
See Fig. 1	15.0	A
Peak Forward Surge Current, 8.3 ms single half sine-wave superimposed on rated load (JEDEC method)	175	A
Maximum Instantaneous Forward Voltage at 15.0A	0.47	V
Maximum DC Reverse Current Ta=25°C	0.2	mA
at Rated DC Blocking Voltage Ta=100°C	20	mA
Typical Junction Capacitance (Note1)		pF
Typical Thermal Resistance R JA (Note 2)	31	°C/W
Operating Temperature Range Tj	-65 — +150	°C
Storage Temperature Range Tstg	-65 — +150	°C

Note : 1.FR-4 PCB, 2oz.Copper.
 2.Polyimide PCB, 2oz.Copper.Cathode pad dimensions 18.8mm x 14.4mm.Anode pad dimensions 5.6mm x 14.4mm.

RATING AND CHARACTERISTIC CURVES (SB1545L LOWVF)

Fig. 1 - Forward Power Dissipation

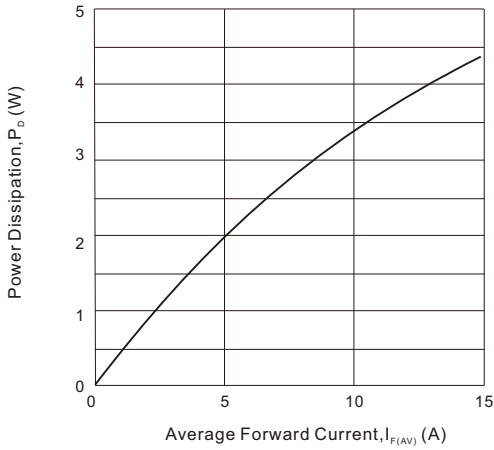

Fig. 2 - Instantaneous Forward Characteristics

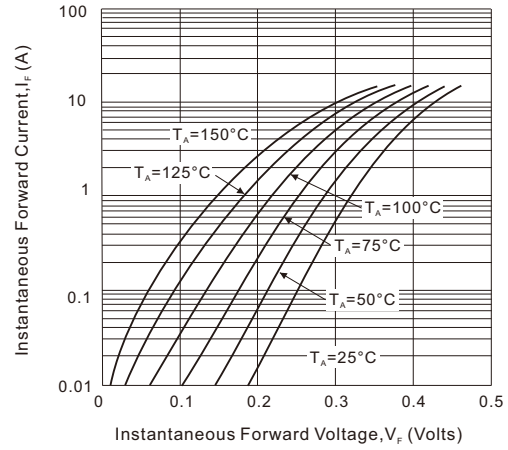

Fig. 3 - Reverse Characteristics

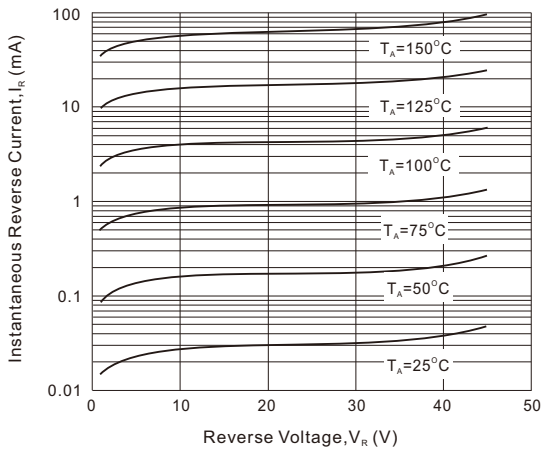

Fig. 4 - Forward Current Derating Curve

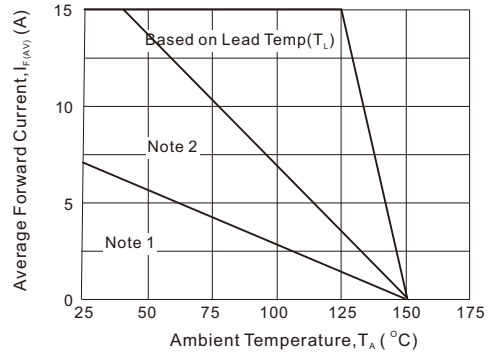

Fig. 5 - Total Capacitance VS. Reverse Voltage

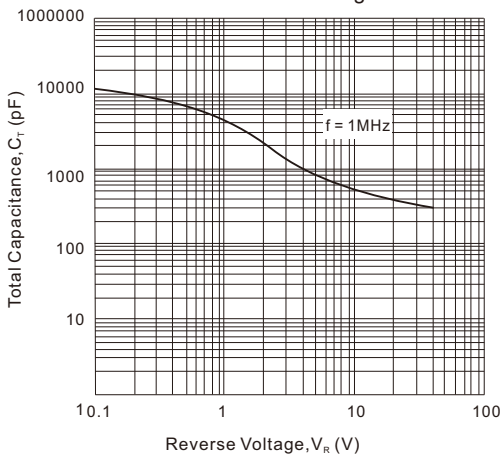
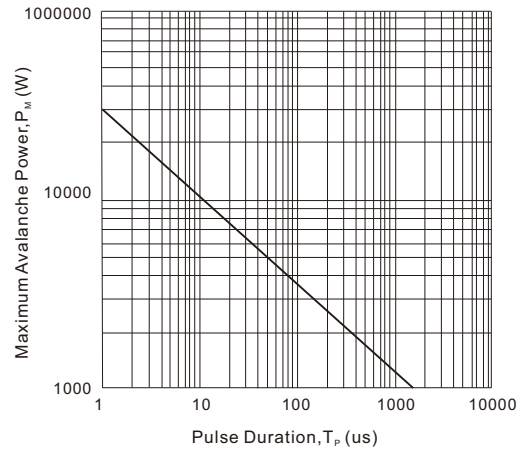

Fig. 6 - Maximum Avalanche Power Curve



X-ON Electronics

Largest Supplier of Electrical and Electronic Components

Click to view similar products for [Schottky Diodes & Rectifiers](#) category:

Click to view products by [SLKORMICRO](#) manufacturer:

Other Similar products are found below :

[MA4E2039](#) [MA4E2508M-1112](#) [MBR1545CT](#) [MMBD301M3T5G](#) [RB160M-50TR](#) [D83C](#) [BAS16E6433HTMA1](#) [BAT 54-02LRH E6327](#)
[NRVBAF360T3G](#) [NSR05F40QNXT5G](#) [NTE555](#) [JANS1N6640](#) [SK310-T](#) [SS3003CH-TL-E](#) [GA01SHT18](#) [CRS10I30A\(TE85L,QM](#)
[MA4E2501L-1290](#) [MBRA140TRPBF](#) [MBRB30H30CT-1G](#) [BAT 15-04R E6152](#) [JANTX1N5712-1](#) [DMJ3940-000](#) [SB007-03C-TB-E](#)
[SK33B-TP](#) [NRVBB20100CTT4G](#) [NRVBM120LT1G](#) [NTSB30U100CT-1G](#) [VS-6CWQ10FNHM3](#) [CRG04\(T5L,TEMQ\)](#) [ACDBA1100LR-HF](#)
[ACDBA1200-HF](#) [ACDBA240-HF](#) [ACDBA3100-HF](#) [CDBQC0530L-HF](#) [CDBQC0240LR-HF](#) [ACDBA260LR-HF](#) [ACDBA1100-HF](#)
[MA4E2502L-1246](#) [10BQ015-M3/5BT](#) [NRVBM120ET1G](#) [CRS08TE85LQM](#) [PMAD1108-LF](#) [B120Q-13-F](#) [1N5819T-G](#) [B0530WSQ-7-F](#)
[PDS1040Q-13](#) [B160BQ-13-F](#) [SDM05U20CSP-7](#) [B140S1F-7](#) [HSM560Je3/TR13](#)