

## Bidirectional TVS Diodes

### DESCRIPTION

The SD03C Series is designed for applications requiring transient overvoltage protection capability. They are intended for use in voltage and ESD sensitive equipment such as computers, printers, business machines, communication systems, medical equipment and other applications. These devices are ideal for situations where board space is at a premium.

This series has been specifically designed to protect sensitive components which are connected to power, data and transmission lines from overvoltage caused by ESD (electrostatic discharge), CDE (Cable Discharge Events), and EFT (electrical fast transients).

### APPLICATIONS

- ✧ Cell Phone Handsets and Accessories
- ✧ Microprocessor based equipment
- ✧ Personal Digital Assistants (PDA's)
- ✧ Notebooks, Desktops, and Servers
- ✧ Portable Instrumentation
- ✧ Networking and Telecom
- ✧ Serial and Parallel Ports.
- ✧ Peripherals

### FEATURES

- ✧ IEC61000-4-2 (ESD)  $\pm 15\text{kV}$  (air),  $\pm 8\text{kV}$  (contact)
- ✧ IEC61000-4-4 (EFT) 40A (5/50ns)
- ✧ 350 Watts Peak Pulse Power per (tp=8/20µs)
- ✧ Protects one I/O line (bidirectional)
- ✧ Low clamping voltage
- ✧ Working voltages : 3V, 5V, 8V, 12V, 15V, 18V, 24V, 36V
- ✧ Low leakage current

### MACHANICAL DATA

- ✧ SOD-323 package
- ✧ Flammability Rating: UL 94V-0
- ✧ Packaging: Tape and Reel
- ✧ High temperature soldering guaranteed: 260°C/10s
- ✧ Reel size: 7 inch
- ✧ Quantity per reel: 3,000pcs

### PIN CONFIGURATION

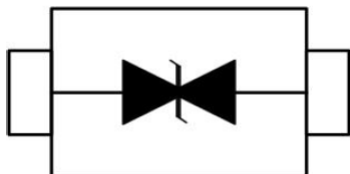

### PACKAGE OUTLINE



| ABSOLUTE MAXIMUM RATING |  |               |       |
|-------------------------|--|---------------|-------|
| Symbol                  | Parameter  | Value         | Units |
| V <sub>ESD</sub>        | ESD per IEC 61000-4-2 (Air)<br>ESD per IEC 61000-4-2 (Contact) | ±15<br>±8     | kV    |
| P <sub>PP</sub>         | Peak Pulse Power (8/20µs)                                      | 350           | W     |
| T <sub>OPT</sub>        | Operating Temperature  | -55/+150      | °C    |
| T <sub>STG</sub>        | Storage Temperature  | -55/+150      | °C    |
| T <sub>L</sub>          | Lead Soldering Temperature                                     | 260 (10 sec.) | °C    |

| ELECTRICAL CHARACTERISTICS (T <sub>amb</sub> =25°C) |                |                  |                |                |                   |                |      |                     |                |
|---|----------------|------------------|----------------|----------------|-------------------|----------------|------|---------------------|----------------|
| PART NUMBER   | DEVICE MARKING | V <sub>RWM</sub> | V <sub>B</sub> | I <sub>T</sub> | V <sub>C@1A</sub> | V <sub>C</sub> |      | I <sub>R</sub>      | C <sub>T</sub> |
|   |                | (V)<br>(max.)    | (V)<br>(min.)  | (mA)           | (V)<br>(max.)     | (max.)<br>)    | (@A) | (µA)<br>(max.)<br>) | (pF)<br>(max.) |
| SD03C   | 2A             | 3.3              | 4.0            | 1              | 7.5               | 13.0           | 20   | 40                  | 450            |
| SD05C   | 2B             | 5.0              | 6.0            | 1              | 9.8               | 18.0           | 17   | 10                  | 200            |
| SD08C   | 2C             | 8.0              | 8.5            | 1              | 13.4              | 24.0           | 15   | 2                   | 120            |
| SD12C   | 2D             | 12.0             | 13.3           | 1              | 19.0              | 32.0           | 11   | 1                   | 75             |
| SD15C   | 2J             | 15.0             | 16.7           | 1              | 24.0              | 38.0           | 10   | 1                   | 68             |
| SD18C   | 2K             | 18.0             | 20.0           | 1              | 29.0              | 45.0           | 9    | 1                   | 57             |
| SD24C   | 2H             | 24.0             | 26.7           | 1              | 43.0              | 52.0           | 7    | 1                   | 50             |
| SD36C   | 2N             | 36.0             | 40.0           | 1              | 60.0              | 75.0           | 5    | 1                   | 35             |

**ELECTRICAL CHARACTERISTICS CURVE**

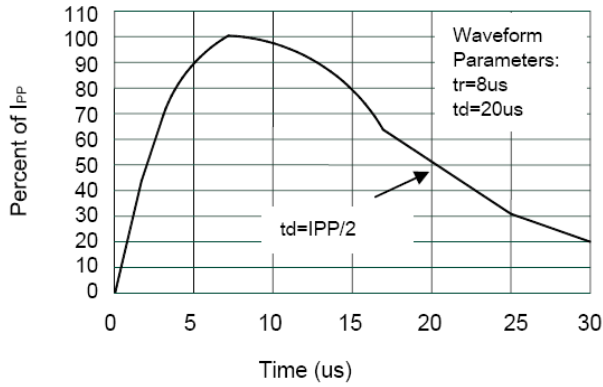

**Pulse Waveform**

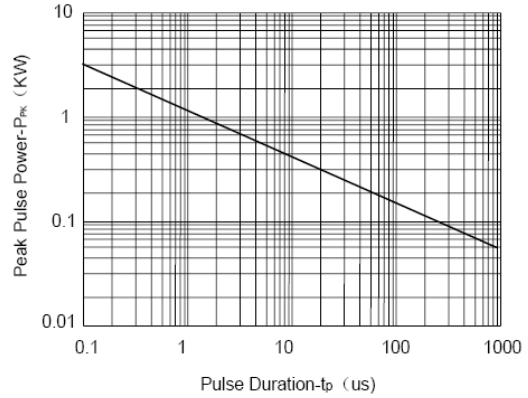

**Non-Repetitive Peak Pulse Power vs. Pulse Time**

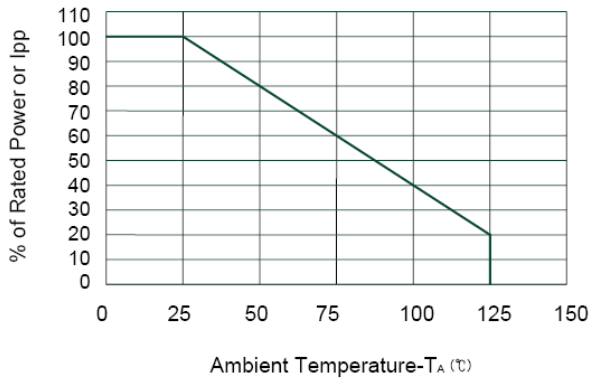

**Power Derating Curve**

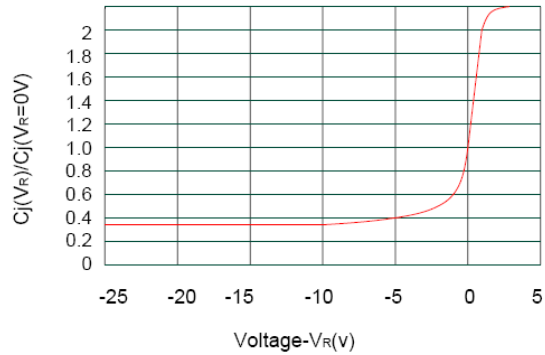

**Junction Capacitance vs. Reverse Voltage**

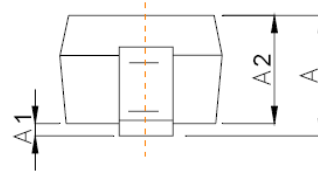
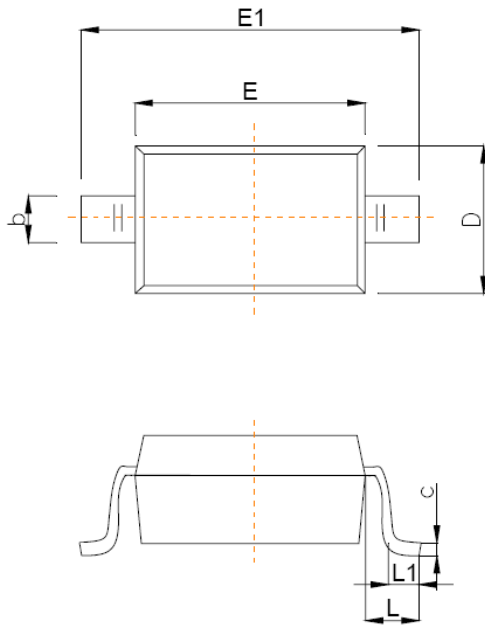
**SOD-323 PACKAGE OUTLINE DIMENSIONS**

| Symbol   | Dimensions In Millimeters |       |
|----------|---------------------------|-------|
|          | Min                       | Max   |
| A        |                           | 1.00  |
| A1       | 0.000                     | 0.100 |
| A2       | 0.800                     | 0.900 |
| b        | 0.250                     | 0.350 |
| c        | 0.080                     | 0.150 |
| D        | 1.200                     | 1.400 |
| E        | 1.600                     | 1.800 |
| E1       | 2.500                     | 2.700 |
| e        | 1.800                     | 2.040 |
| L        | 0.475 REF                 |       |
| L1       | 0.250                     | 0.400 |
| $\theta$ | 0°                        | 8°    |

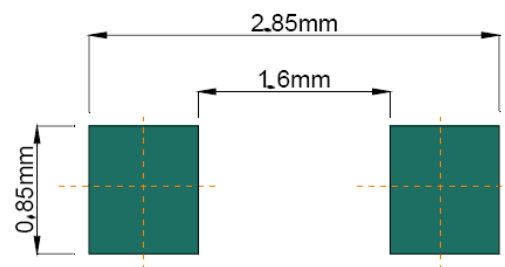
**Recommended Pad outline**

## X-ON Electronics

Largest Supplier of Electrical and Electronic Components

*Click to view similar products for [ESD Suppressors / TVS Diodes](#) category:*

*Click to view products by [SLKORMICRO](#) manufacturer:*

Other Similar products are found below :

[60KS200C](#) [D18V0L1B2LP-7B](#) [D5V0F4U5P5-7](#) [NTE4902](#) [P4KE27CA](#) [P6KE11CA](#) [P6KE8.2A](#) [SA60CA](#) [SA64CA](#) [SMBJ12CATR](#)  
[SMBJ33CATR](#) [SMBJ6.5A](#) [SMBJ8.0A](#) [ESD101-B1-02ELS E6327](#) [ESD112-B1-02EL E6327](#) [ESD7451N2T5G](#) [19180-510](#) [CPDT-5V0USP-](#)  
[HF](#) [3.0SMCJ33CA-F](#) [3.0SMCJ36A-F](#) [HSPC16701B02TP](#) [JANTX1N6126A](#) [D3V3Q1B2DLP3-7](#) [D55V0M1B2WS-7](#) [SCM1293A-04SO](#)  
[ESD200-B1-CSP0201 E6327](#) [SM12-7](#) [CEN955 W/DATA](#) [VESD12A1A-HD1-GS08](#) [CPDQC5V0-HF](#) [D1213A-01LP4-7B](#) [ESD101-B1-02EL](#)  
[E6327](#) [AOZ8808DI-03](#) [5KP15A](#) [5KP48A](#) [5KP90A](#) [ESD3V3D7-TP](#) [15KPA36A-LF](#) [P4KE56CA](#) [P4KE68A](#) [P4KE91CATR](#) [P6KE120A](#)  
[P6KE13CA](#) [P6KE43CA](#) [P6KE6.8CA](#) [P6KE8.2](#) [P6SMBJ20CA](#) [JANTX1N6072A](#) [SR2835ESKG](#) [SA90CA](#)