

● 特点 (Features)

1. 电流转换比(CTR : MIN. 50% at IF = 5mA, VCE = 5V, Ta=25 °C)
2. 绝缘电压: (VISO=5,000Vrms)
3. 高集电极发射极电压(VCEO = 70V)
4. 温度范围: -55 °C to 110 °C
5. 长爬电距离: > 8mm , 无铅, 符合 RoHS 标准。
6. CQC approved(No.15801-CQC001041-201800042)
7. VDE approved(No.40029733)

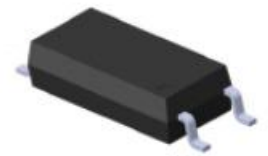

● 说明

描述该 SL-10XX 系列器件包含一个红外发光二极管, 光电晶体管探测器。不含卤素和 Sb₂O₃. 它们封装在一个 4 引脚 SOP 里面。

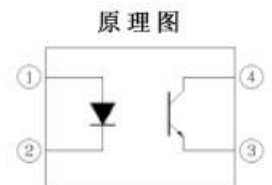

引脚配置

1. 阳极
2. 阴极
3. 发射极
4. 集电极

● 应用范围 (Application Range)

- 可编程控制器
- 系统设备, 测量仪器
- 电信设备
- 家用电器, 如风扇加热器等。
- 不同的电势和阻抗的电路之间的信号传输

● 最大绝对额定值 (常温 T=25°C) Max Absolute rated Value (Normal Temperature=25°C)

参数 Parameter		符号 Symbol	额定值 Rated Value	单位 Unit
输入 Input	正向电流 (Forward Current)	I _F	60	mA
	结区温度 (Junction Temperature)	T _J	125	°C
	逆向电压 (Reverse Voltage)	V _R	6	V
	耗散功率 (Consume Power)	P	100	mW
输出 Output	集极与射极电压 (Collector and emitter Voltage)	V _{CEO}	80	V
	射极与集极电压 (Emitter and collector Voltage)	V _{ECO}	7	
	集极电流 (Collector Current)	I _C	50	mA
	消耗功率 (Consume Power)	P _C	150	mW
总功率消耗 (Total Consume Power)		P _{tot}	250	mW
*1 绝缘电压 (Insulation Voltage)		V _{iso}	5000	Vrms
工作温度 (Working Temperature)		T _{opr}	-30 to + 110	°C
存贮温度 (Deposit Temperature)		T _{stg}	-55 to + 125	
*2 焊锡温度 (Soldering Temperature)		T _{sol}	260	

*1. 交流测试, 时间 1 分钟, 湿度 =40~60% AC Test, 1 minute, humidity = 40~60%

如下是绝缘测试的方法. Insulation test method as below:

- (1) 将产品的两端短路。 Short circuit both terminals of photocoupler
- (2) 测试绝缘电压时无电流通过。 No Current when testing insulation voltage
- (3) 测试时加正弦波形电压。 Adding sine wave voltage when testing

*2. 锡焊时间为 10 秒 soldering time is 10 seconds

● 光电特性(常温 T=25°C) (Opto-electronic Characteristics)

参数 Parameter		符号 Symbol	条件 Condition	最小 Min	典型值 Typ.*	最大 Max	单位 Unit
输入 (Input)	正向电压 (Forward Current)	V_F	$I_F=50\text{mA}$	---	1.25	1.5	V
	反向电压 (Reverse Voltage)	I_R	$V_R=6\text{V}$	---	---	10	μA
	集极电容 (Collector capacitance)	C_t	$V=0, f=1\text{ KHz}$	---	50	---	pF
输出 (Output)	集极至射极电流 (Collector to emitter Current)	I_{CEO}	$V_{CE}=20\text{V}, I_F=0$	---	---	100	nA
	集极与射极衰减电压 (Collector and Emitter attenuation Voltage)	BV_{CEO}	$I_C=0.1\text{mA}, I_F=0$	80	---	---	V
	射极与集极衰减电压 (Emitter and Collector attenuation Voltage)	BV_{ECO}	$I_E=0.1\text{mA}, I_F=0$	7	---	---	V
传输特性 (Transforming Characteristics)	*1 电流转换比 (Current conversion ratio)	CTR	$I_F=5\text{mA}, V_{CE}=5\text{V}$	50	---	600	%
	集极电流 (Collector Current)	I_C		2.5	---	30	mA
	集极与射极饱和电压 (Collector and Emitter Saturation Voltage)	$V_{CE(sat)}$	$I_F=10\text{mA}, I_C=1\text{mA}$	---	---	0.3	V
	绝缘阻抗 (Insulation Impedance)	R_{iso}	DC500V 40~60%R.H.	5×10^{10}	1×10^{11}	---	Ω
	浮动电容 (Floating Capacitance)	C_f	$V=0, f=1\text{MHz}$	---	0.6	1	pF
	上升时间 (Response Time)	t_r	$V_{CC}=2\text{V}, I_C=2\text{mA}$	---	---	18	μs
	下降时间 (Descend Time)	t_f	$R_L=100\Omega$	---	---	18	μs

- 电流转换比 Current Conversion Ratio = $I_C / I_F \times 100\%$

● 电流传输比的等级分类 (Rank table of current transfer ratio CTR)

CTR Rank	Min.	Typ.	Max.	Unit	测试条件 (Condition)
SL-1000	50	—	600	%	IF=5mA, V _{CE} =5V, Ta=25°C
SL-1001	100	—	160		
SL-1004	100	—	200		
SL-1005	50	—	150		
SL-1006	100	—	300		
SL-1007	80	—	160		
SL-1008	130	—	260		
SL-1009	200	—	400		
SL-1010	150	—	300		
SL-1019	250	—	500		
SL-1020	300	—	450		
SL-1002	22	—	—	%	IF=1mA, V _{CE} =5V, Ta=25°C
SL-1003	34	—	—		
SL-1014	56	—	—		
SL-1015	63	—	125		
SL-1018	100	—	200		
SL-1002	63	—	125	%	IF=10mA, V _{CE} =5V, Ta=25°C
SL-1003	100	—	200		
SL-1014	160	—	320		

● 外形尺寸 (Outer Dimension)

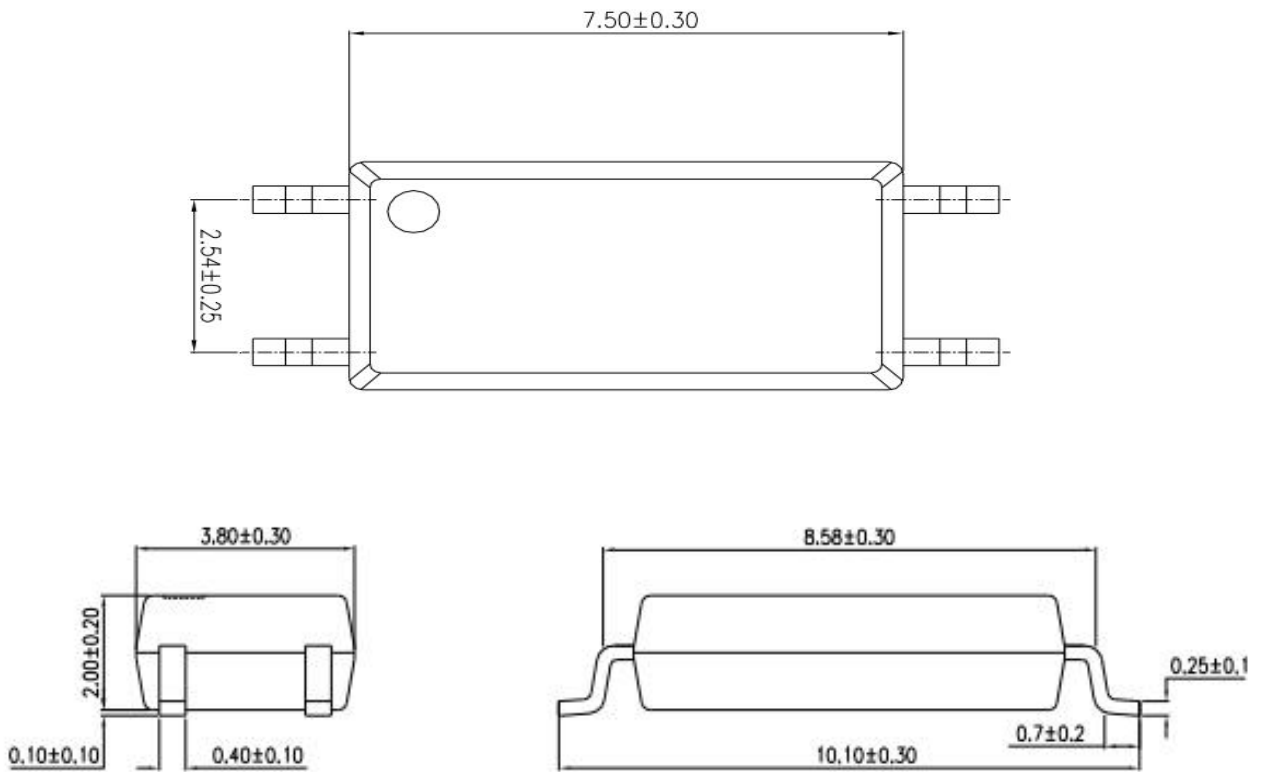

● 推荐的焊盘尺寸 (Recommended Foot Print Patterns (Mount Pad))

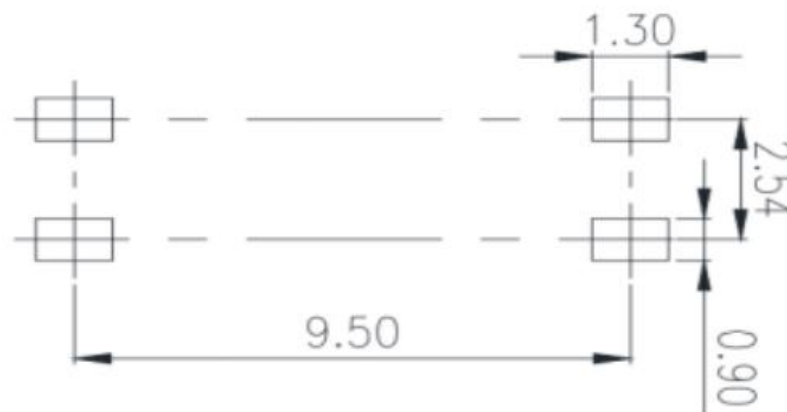

单位: mm

● 编带尺寸 (Taping Dimensions)

1. SL-10XX-TP

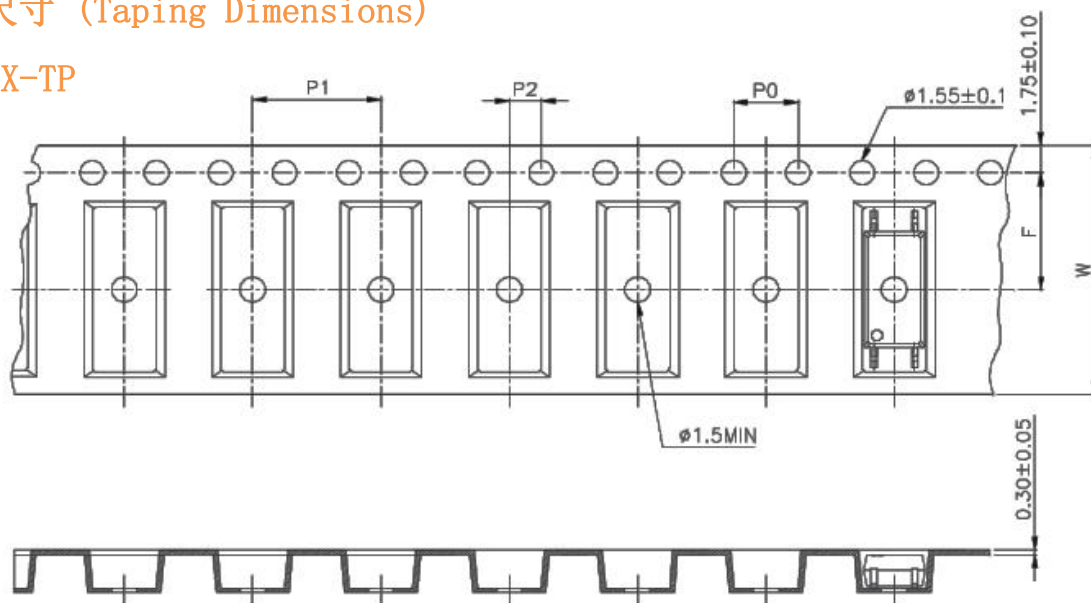

2. SL-10XX-TP1

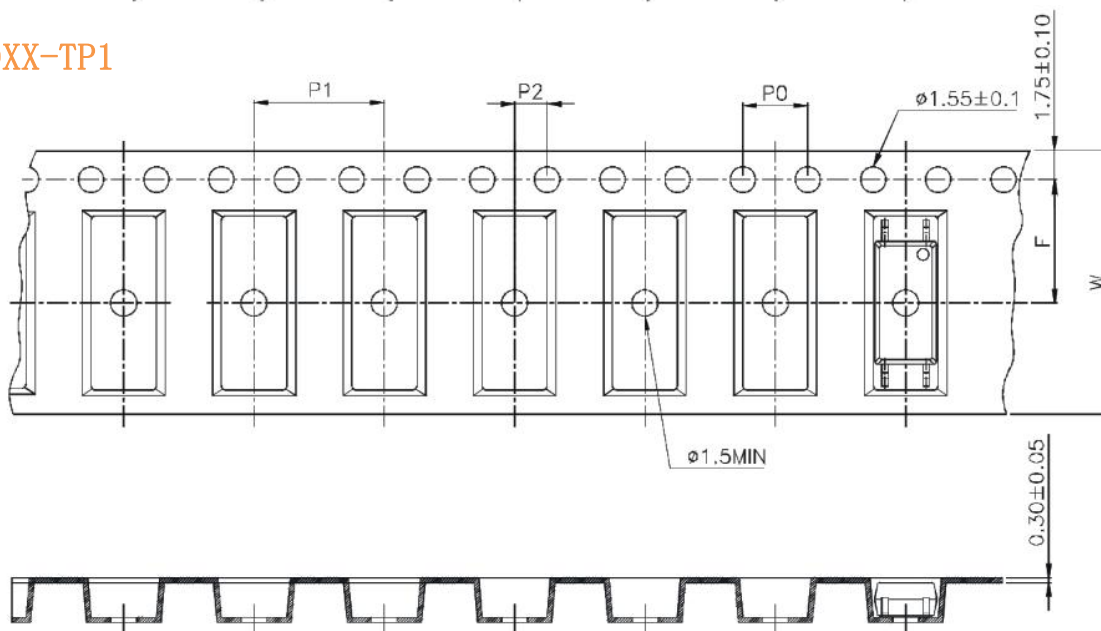

类型	符号	尺寸:毫米(英寸)
带宽	W	16 ± 0.3 (.63)
孔距	P0	4 ± 0.3 (.63)
孔距	F	7.5 ± 0.1 (.295)
	P2	2 ± 0.1 (.079)
间隔	P1	8 ± 0.1 (.315)

封装类型	SL-10XX series
数量 (个)	3000

● 焊接温度曲线图 (Temperature Profile Of Soldering)

1. 红外回流焊 (jedec-std-020c 兼容) (IR Reflow soldering (JEDEC-STD-020C compliant))

注意：一次焊接回流建议在温度和时间配置文件如下所示的条件下。不要焊接超过三次。

配置项	条件
预热 (Preheat)	
-最低温度 (T _{Smin})	150°C
-最高温度 (T _{Smax})	200°C
-时间 (最小到最大 (T _S))	90±30 sec
焊接区 (Soldering zone)	
-温度 (T _L)	217°C
-时间 (t _L)	60 sec
峰值温度 (Peak Temperature)	260°C
爬升率 (Ramp-up rate)	3°C / sec max.
下降率 (3°C / sec max.)	3~6°C / sec

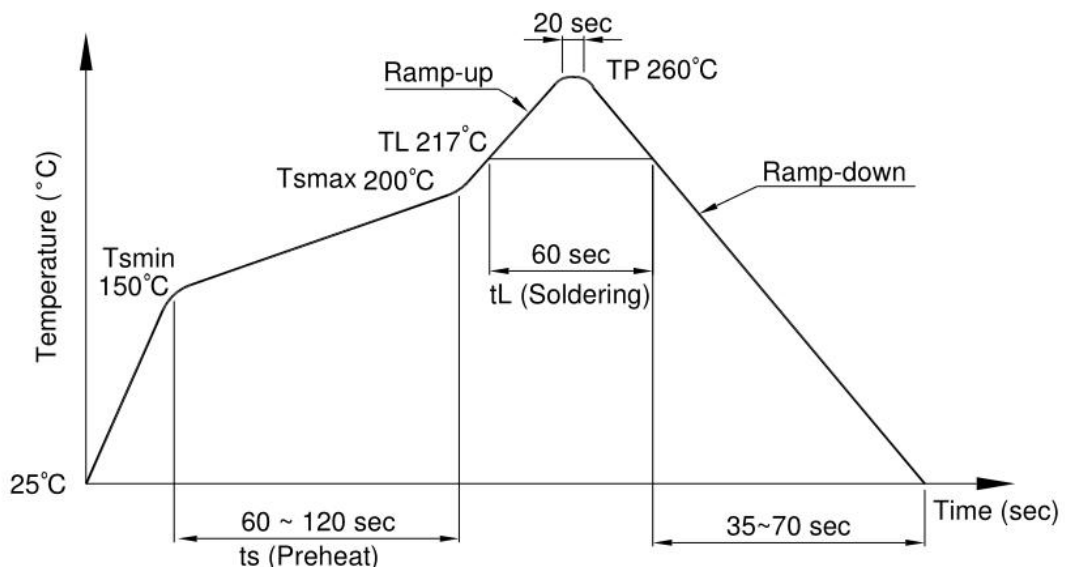

2. 波峰焊接 (jedec22a111 兼容) (Wave soldering (JEDEC22A111 compliant))

建议在温度条件下一致性焊接。

温度 (Temperature)	260+0/-5°C
时间 (Time)	10 sec
预热温度 (Preheat temperature)	5 to 140°C
预热时间 (Preheat time)	30 to 80 sec

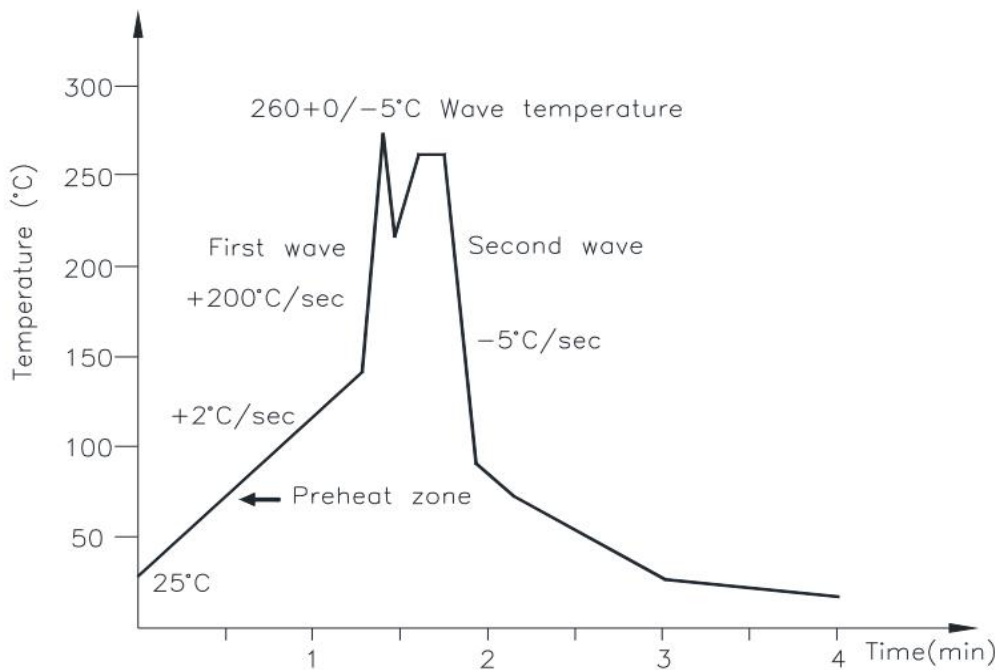

3. 电烙铁手工焊接 (Hand soldering by soldering iron)

允许单铅焊接在每一个过程中, 建议一次性焊接。

温度 (Temperature)	380+0/-5°C
时间 (Time)	3 sec max

● 特性曲线 (Characteristics Curve)

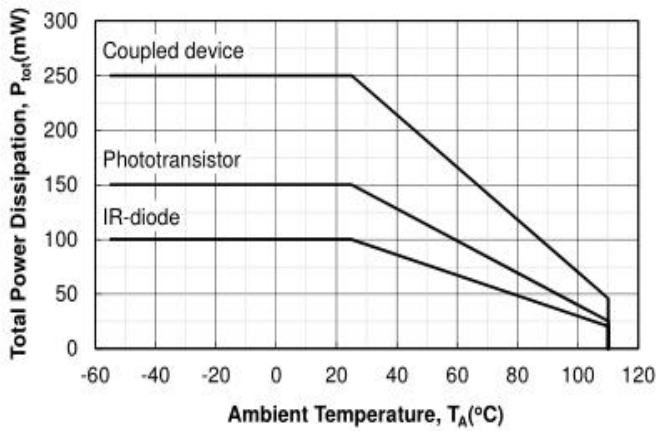

Figure 1. P_{tot} vs. T_A

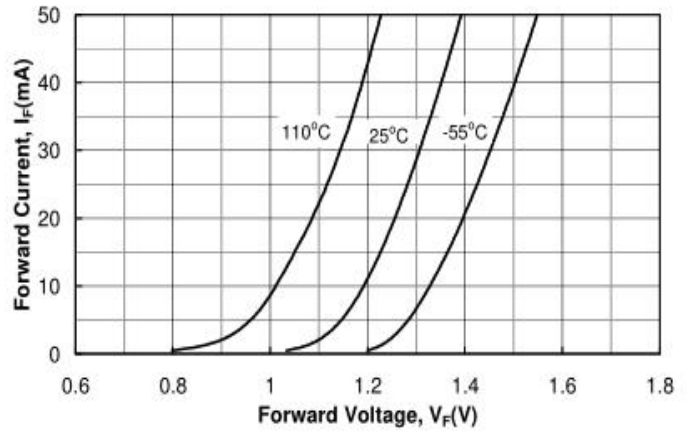

Figure 4. I_F vs. V_F

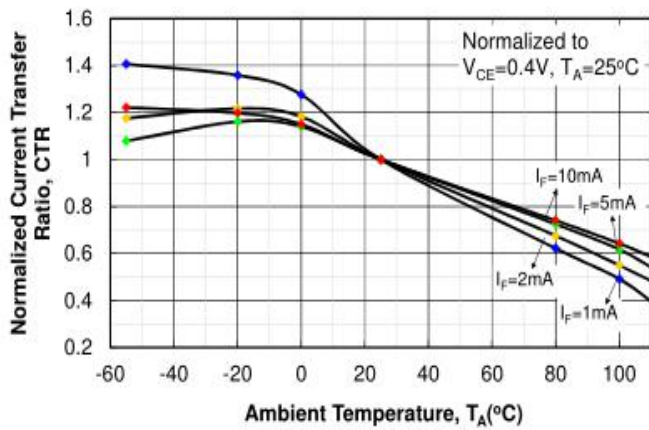

Figure 2. Saturated Normalized CTR vs. T_A

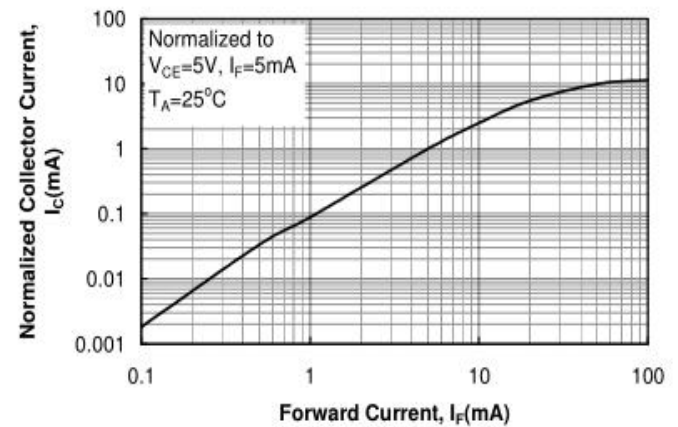

Figure 5. Normalized I_C vs. I_F

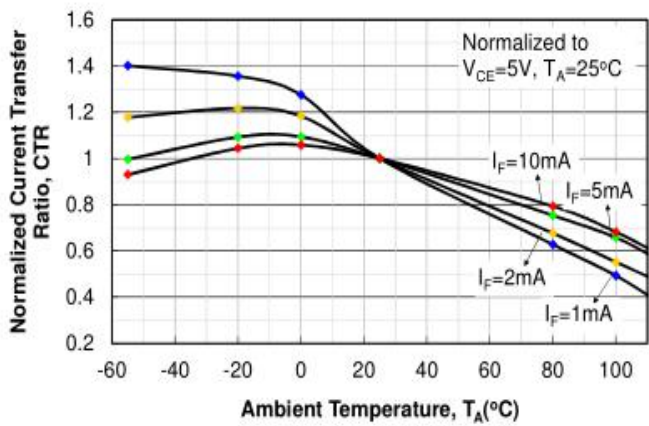

Figure 3. Non-saturated Normalized CTR vs. T_A

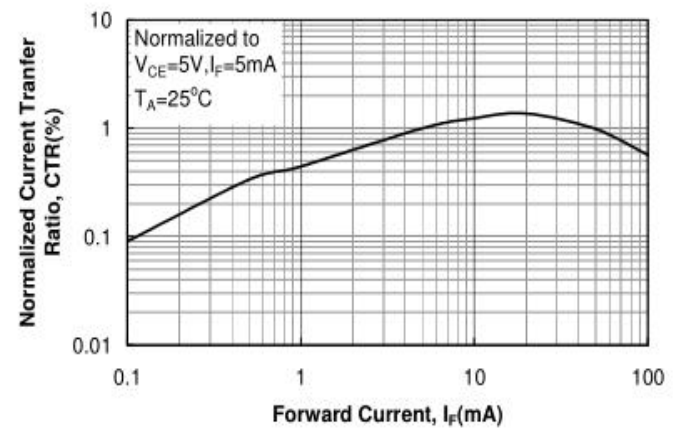

Figure 6. Normalized CTR vs. I_F

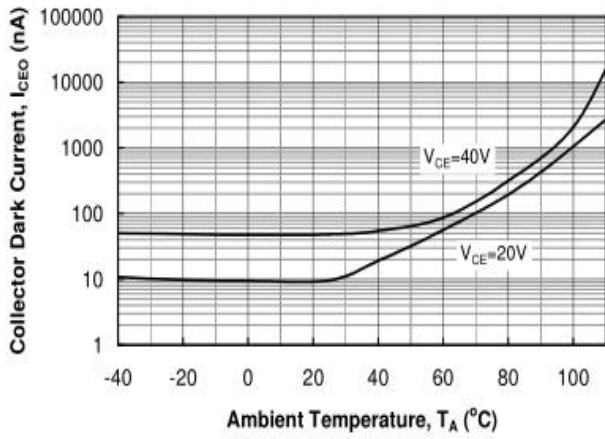

Figure 7. I_{CEO} vs. T_A

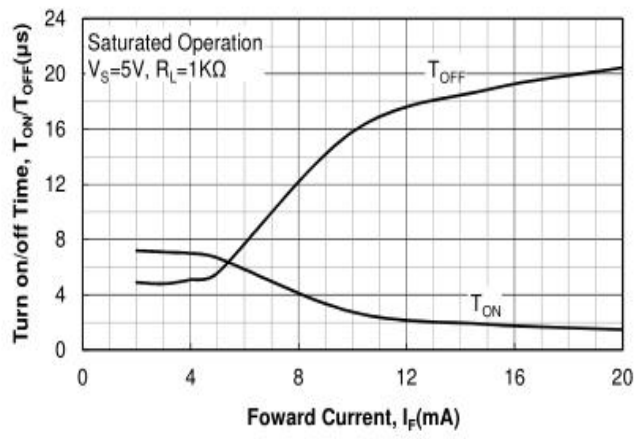

Figure 10. T_{ON} / T_{OFF} vs. I_F

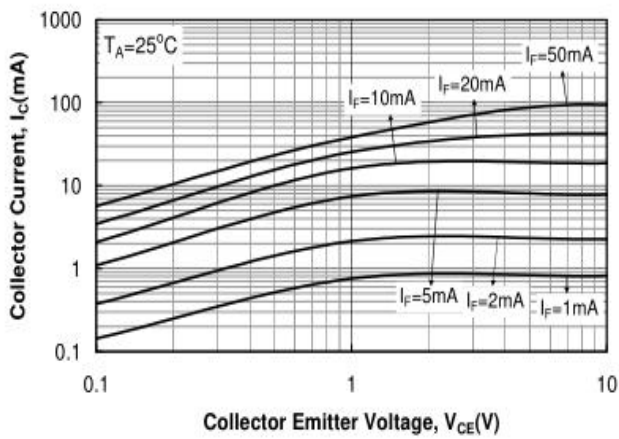

Figure 8. I_C vs. V_{CE}

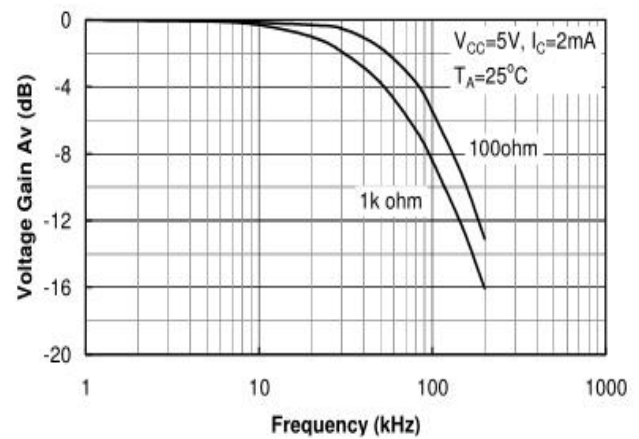

Figure 11. Frequency Response

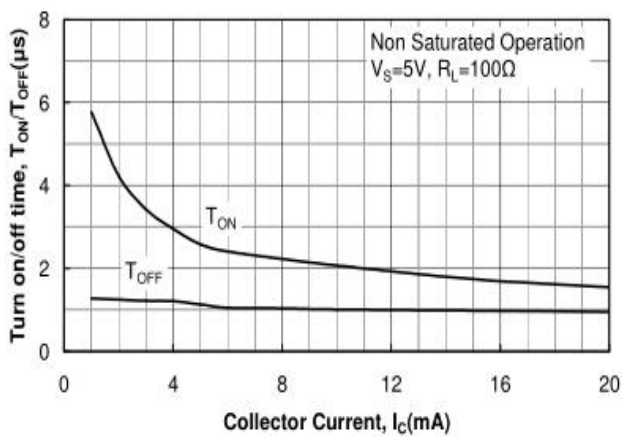

Figure 9. T_{ON} / T_{OFF} vs. I_C

X-ON Electronics

Largest Supplier of Electrical and Electronic Components

Click to view similar products for [Photodiode Output Optocouplers](#) category:

Click to view products by [SLKORMICRO](#) manufacturer:

Other Similar products are found below :

[TLP590B\(C,F\)](#) [TLP5214\(D4.E\(O](#) [TLP7820\(A-LF4.E\(O](#) [EL817MB](#) [EL817S1\(B\)\(TU\)-FV](#) [EL357NB](#) [LTV-244-GB-G](#) [ORPC-817SB-TP-C](#)
[OR-357D](#) [OR-357B-S-TP-G](#) [OR-3H4-4GB-TA1-GK](#) [OR-3H7-4GB-TA1-GK](#) [OR-M501-TP-G](#) [OR-3H5-TP-G](#) [OR-3H4B-TP-G](#) [OR-357C-S-](#)
[TP-G](#) [PC817X3NIPW](#) [PC817X2YSZW](#) [SL-1008](#) [SL-1009](#) [PC817C](#) [LTV-354T](#) [PC817C](#) [PC357C](#) [LTV-356T-C](#) [SL-1007](#) [PC817X2YIPW](#)
[OR-3H4A-TP-G](#) [PC817C-S](#) [ORPC-815-C](#) [ORPC-852](#) [OR-M611-TP-G](#) [ORPC-815S](#) [PS2701-1-L](#) [UPC817XG-D04-T](#) [LTV2301GB-V-G](#)
[TLP621GB-1S](#) [KPC452 0E](#) [EL817\(D\)-FG](#) [EL817S1B\(F\)](#) [EL817M\(C\)\(TH\)-F](#) [IS281](#) [APV2111V](#) [APV1121SX](#) [APV2111VY](#)
[TLP3906\(TPL,E](#) [TLP591B\(C,F\)](#) [TLP3905\(E](#) [IS281GR](#) [APS1241S](#)