

Features

- Low gate charge
- Low C_{rss} (typ 13pF)
- Fast switchin
- 100% avalanche tested
- Improved dv/dt capability
- RoHS product

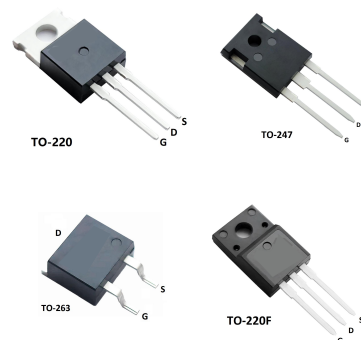

Applications

- High frequency switching mode power supply
- Electronic ballast based on half bridge
- LED power supplies

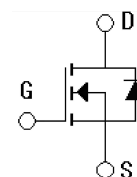

Absolute Ratings (Tc=25°C)

Parameter	Symbol	Value	Unit
Drain-Source Voltage	V_{DSS}	1000	V
Drain Current-continuous	I_D T=25°C T=100°C	12	A
		8	A
Drain Current-pulse (note 1)	I_{DM}	64*	A
Gate-Source Voltage	V_{GS}	±30	V
Single pulse avalanche energy (note 2)	E_{AS}	858	mJ
Avalanche Current (note 1)	I_{AR}	12	A
Repetitive Avalanche Energy(note 1)	E_{AR}	27.7	mJ
Power Dissipation (SL12N100/T)	PD TC=25°C Derate above 25°C	272	W
		2.17	W/°C
Power Dissipation (SL12N100K)	PD TC=25°C Derate above 25°C	100	W
		0.8	W/°C
Power Dissipation (SL12N100F)	PD TC=25°C Derate above 25°C	68	W
		0.54	W/°C

Operating and Storage Temperature Range	T_J, T_{STG}	-55~+150	°C
Maximum Lead Temperature for Soldering Purposes	T_L	300	°C

*Drain current limited by maximum junction temperature

Electrical Characteristics($T_{CASE}=25^{\circ}C$ unless otherwise specified)

Parameter	Symbol	Tests conditions	Min	Type	Max	Units
Drain-Source Voltage	BV_{DSS}	$I_D=250\mu A, V_{GS}=0V$	1000	-	-	V
Breakdown Voltage Temperature Coefficient	$\Delta BV_{DSS}/\Delta T_J$	$I_D=250\mu A$, referenced to $25^{\circ}C$	-	0.98	-	V/°C
Zero Gate Voltage Drain Current	I_{DSS}	$V_{DS}=800V, V_{GS}=0V, T_C=25^{\circ}C$	-	-	1	μA
		$V_{DS}=720V, T_C=125^{\circ}C$	-	-	10	μA
Gate body leakage current	I_{GSS}	$V_{DS}=0V, V_{GS}=\pm 30V$	-	-	± 100	nA
On-Characteristics						
Gate Threshold Voltage	$V_{GS(th)}$	$V_{DS}=V_{GS}, I_D=250\mu A$	3.0	-	5.0	V
Static Drain-Source On-Resistance	$R_{DS(ON)}$	$V_{GS}=10V, I_D=6A, T_C=25^{\circ}C$	-	1.0	1.2	Ω
Forward Transconductance	g_{FS}	$V_{DS}=40V, I_D=6A$ (note 4)	-	9.5	-	S
Dynamic Characteristics						
Input capacitance	C_{iss}	$V_{DS}=25V, V_{GS}=0V, f=1.0MHZ$	-	2150	2830	pF
Output capacitance	C_{oss}		-	189	246	pF
Reverse transfer capacitance	C_{rss}		-	13	17	pF

Electrical Characteristics($T_{CASE}=25^{\circ}C$ unless otherwise specified)

Parameter	Symbol	Tests conditions	Min	Type	Max	Units
Switching-Characteristics						
Turn-On delay time	$t_{d(on)}$	$V_{DD}=600V, I_D=12A, R_{GEN}=25\Omega$ (note 4,5)	-	53	121	ns
Turn-On rise time	t_r		-	116	235	ns
Turn-Off delay time	$t_{d(Off)}$		-	97	199	ns

Turn-Off rise time	t_f		-	69	171	ns
Total Gate Charge	Q_g	$V_{DS}=800V, I_D=12A,$ $V_{GS}=10V$ (note 4,5)	-	43	56	nC
Gate-Source charge	Q_{gs}		-	15	-	nC
Gate-Drain charge	Q_{gd}		-	21	-	nC
Drain-Source Diode Characteristics and Maximum Ratings						
Diode Forward Voltage (note 3)	V_{SD}	$V_{GS}=0V, I_S=12A$	-	-	1.4	V
Maximum Pulsed Drain-Source Diode Forward Current	I_{SM}	-	-	-	48	A
Maximum Continuous Drain Source Diode Forward Current	I_S	-	-	-	12	A
Reverse recovery time	t_{rr}	$V_{GS}=0V,$	-	539	-	ns
Reverse recovery charge	Q_{rr}	$I_S=8A \text{ di}_F/\text{dt}=100A/\mu\text{s}$ (note 4)	-	6.41	-	μC

Thermal Characteristic

Parameter	Symbol	Value			Unit
		SL12N100 / T	SL12N100 K	SL12N100 F	
Thermal Resistance, junction to Case	$R_{th(j-C)}$	0.46	1.25	1.84	$^{\circ}\text{C}/\text{W}$
Thermal Resistance, Junction to Ambient	$R_{th(j-A)}$	40	62.5	62.5	$^{\circ}\text{C}/\text{W}$

Order information

Order codes	Package	Packaging
SL12N100T	TO-247	Tube
SL12N100K	TO-263	Tube
SL12N100	TO-220	Tube
SL12N100F	TO-220F	Tube

Notes:

1. Pulse width limited by maximum junction temperature
2. $L=20\text{mH}, I_{AS}=12A, V_{DD}=50V, R_G=25 \Omega, \text{Starting } T_J=25^{\circ}\text{C}$
3. $I_{SD} \leq 12A, di/dt \leq 300A/\mu\text{s}, V_{DD} \leq BV_{DSS}, \text{Starting } T_J=25^{\circ}\text{C}$
4. Pulse Test: Pulse Width $\leq 300\mu\text{s}, \text{Duty Cycle} \leq 2\%$
5. Essentially independent of operating temperature

ELECTRICAL CHARACTERISTICS (curves)

On-Region Characteristics

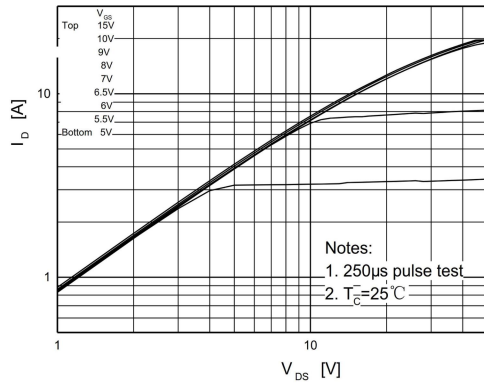

Transfer Characteristics

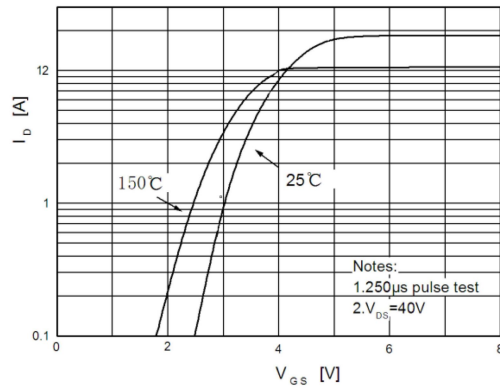

On-Resistance Variation vs. Drain Current Gate Voltage

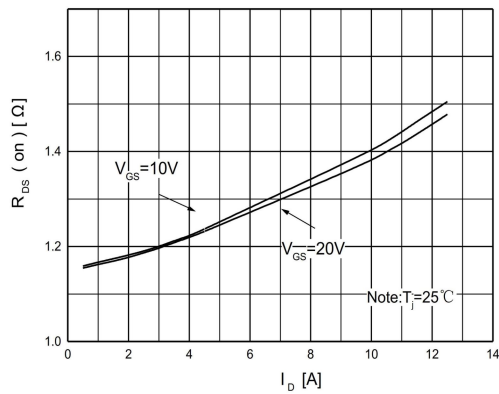

Body Diode Forward Voltage Variation vs. Source Current and Temperature

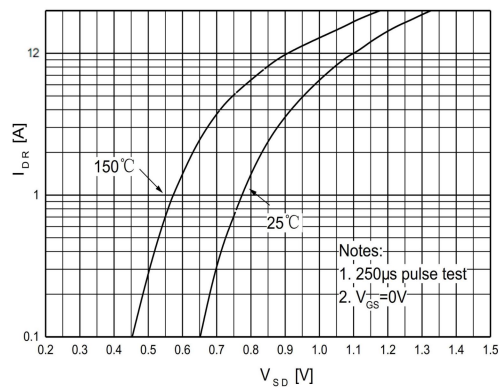

Capacitance Characteristics

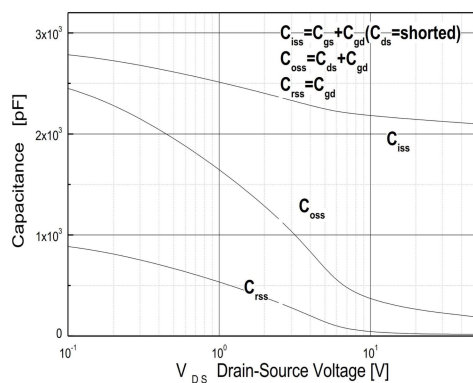

Gate Charge Characteristics

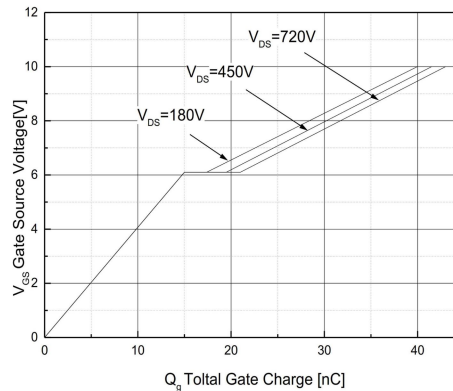

Breakdown Voltage Variation vs. Temperature

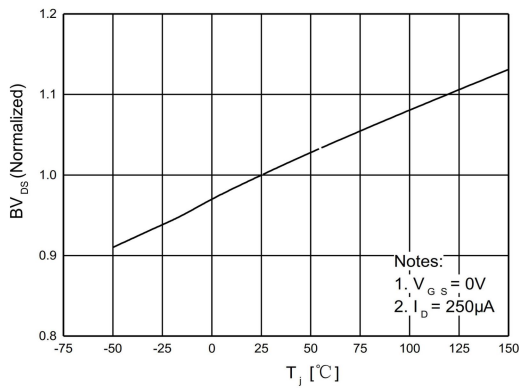

On-Resistance Variation vs. Temperature

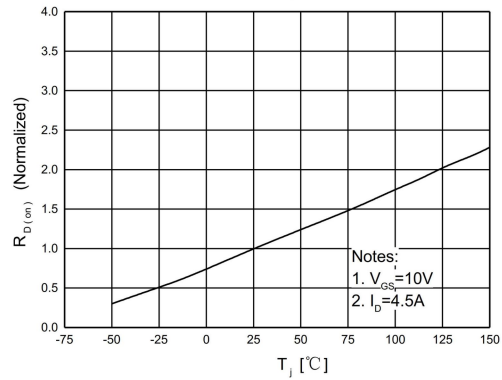

Maximum Safe Operating Area

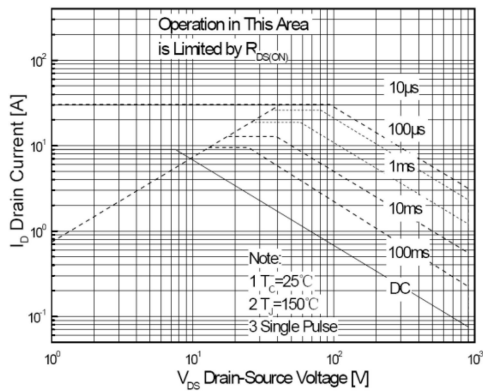

Maximum Drain Current vs. Case Temperature

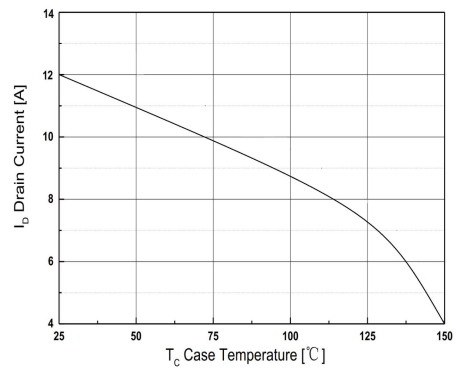

Transient Thermal Respon Curve

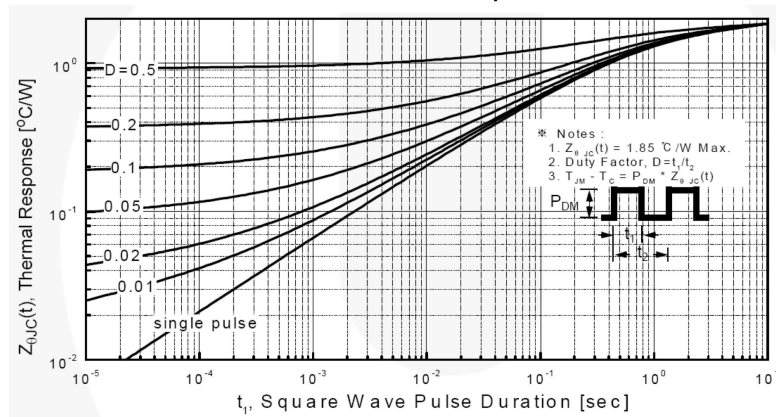

PACKAGE MECHANICAL DATA

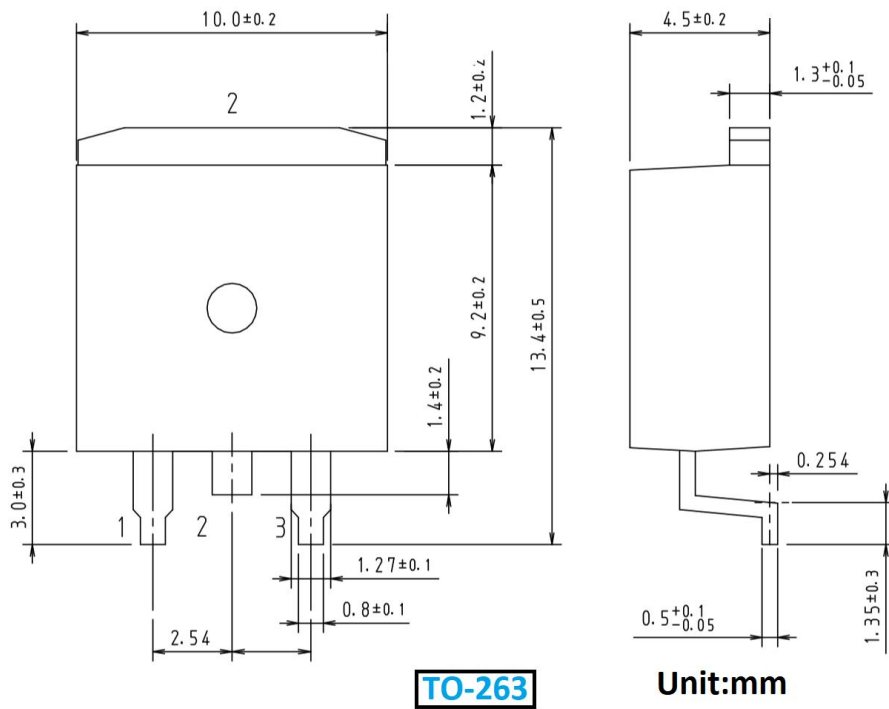
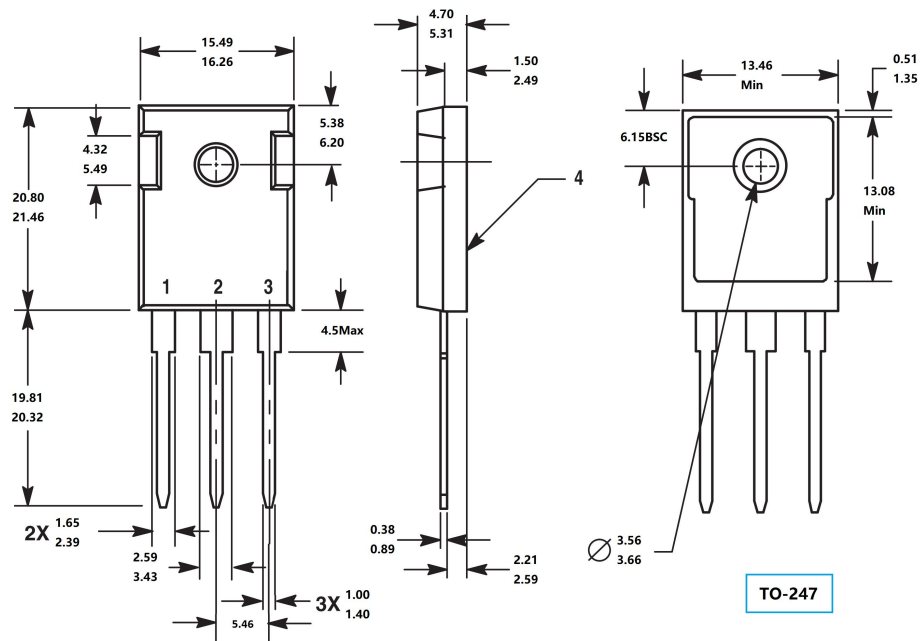

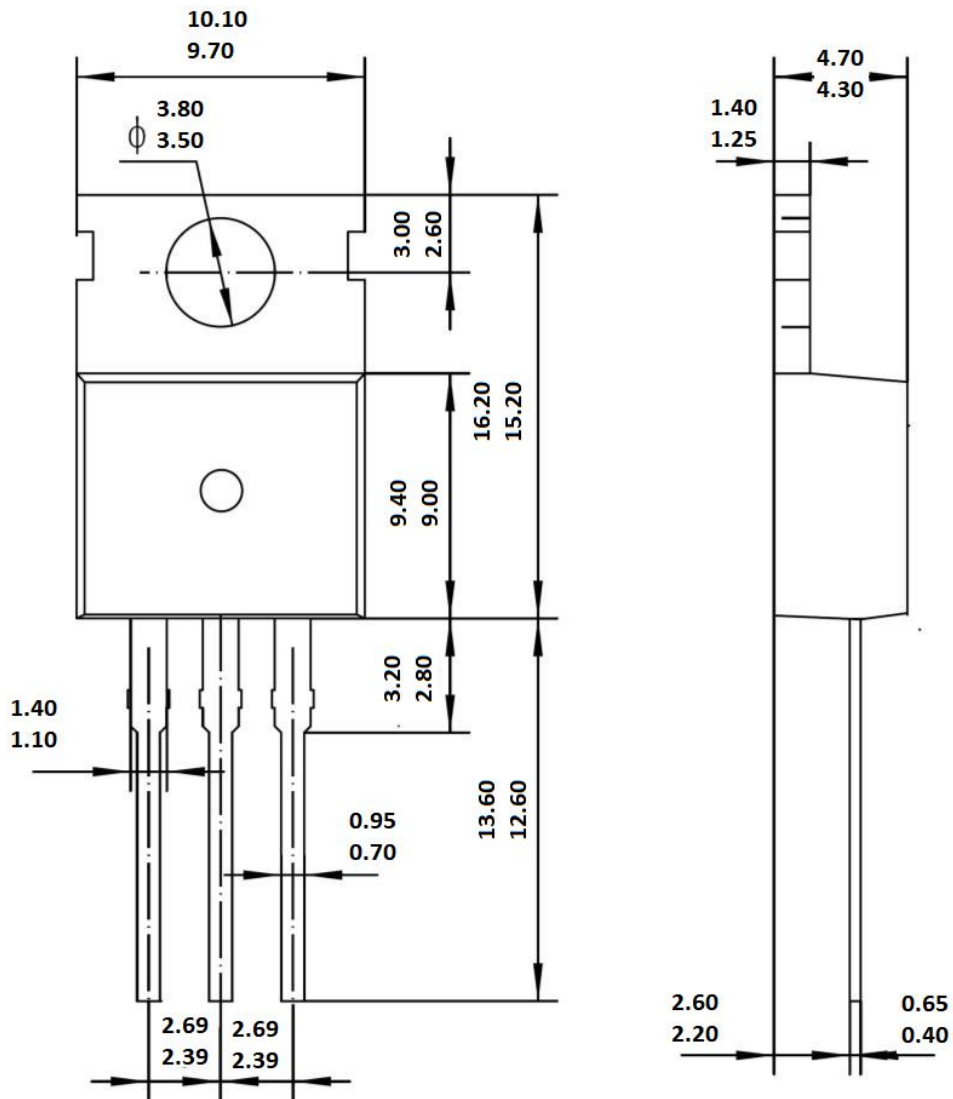

TO-220

Unit: mm

X-ON Electronics

Largest Supplier of Electrical and Electronic Components

Click to view similar products for [MOSFET](#) category:

Click to view products by [SLKORMICRO](#) manufacturer:

Other Similar products are found below :

[IRFD120](#) [JANTX2N5237](#) [BUK455-60A/B](#) [MIC4420CM-TR](#) [VN1206L](#) [NDP4060](#) [SI4482DY](#) [IPS70R2K0CEAKMA1](#) [SQD23N06-31L-GE3](#)
[TK16J60W,S1VQ\(O](#) [2SK2614\(TE16L1,Q\)](#) [DMN1017UCP3-7](#) [DMN1053UCP4-7](#) [SQJ469EP-T1-GE3](#) [NTE2384](#) [DMC2700UDMQ-7](#)
[DMN2080UCB4-7](#) [DMN61D9UWQ-13](#) [US6M2GTR](#) [DMN31D5UDJ-7](#) [DMP22D4UFO-7B](#) [DMN1006UCA6-7](#) [DMN16M9UCA6-7](#)
[STF5N65M6](#) [IRF40H233XTMA1](#) [STU5N65M6](#) [DMN6022SSD-13](#) [DMN13M9UCA6-7](#) [DMTH10H4M6SPS-13](#) [DMN2990UFB-7B](#)
[IPB80P04P405ATMA2](#) [2N7002W-G](#) [MCAC30N06Y-TP](#) [MCQ7328-TP](#) [BXP7N65D](#) [BXP4N65F](#) [AOL1454G](#) [WMJ80N60C4](#) [BXP2N20L](#)
[BXP2N65D](#) [BXT1150N10J](#) [BXT1700P06M](#) [TSM60NB380CP](#) [ROG](#) [RQ7L055BGTCR](#) [DMNH15H110SK3-13](#) [SLF10N65ABV2](#)
[BSO203SP](#) [BSO211P](#) [IPA60R230P6](#) [IPA60R460CE](#)