

Features

- Low gate charge
- Trench FS Technology,
- saturation voltage: $V_{CE(sat)}$,
typ = 1.6V, $I_C=20A$ and $T_C=25^\circ C$
- RoHS product

Applications

- General purpose inverters
- UPS

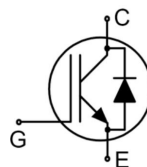

TO-220F G C E

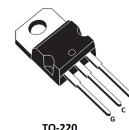

TO-220

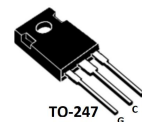

TO-247 G C E

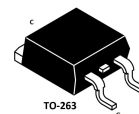

TO-263

Absolute Ratings ($T_C=25^\circ C$)

Parameter	Symbol	SL20T65F	SL20T65 / SL20N65FZ	SL20T65FL	Unit
Collector-Emmitter Voltage	V_{ces}	650			V
Collector Current-continuous	I_C $T=25^\circ C$ $T=100^\circ C$	40			A
		20			A
Collector Current-pulse(note 1)	I_{CM}	80			A
Diode RMS forward current	I_F $T=25^\circ C$ $T=100^\circ C$	40			A
		20			A
Gate-Emmitter Voltage	V_{GES}	± 20			V
Turn-off safe area	-	180			A
Surge non repetitive forward current $t_p=10ms$ sinusoidal	I_{FSM}	80			A
Power Dissipation	P_D $T_C=25^\circ C$	35	156	162	W
Diode Forward Current	$T_C=100^\circ C$	20			A
Storage Temperature Range	T_{STG}	-55~+150			$^\circ C$
Operating Temperature Range	T_J	-55~+175			$^\circ C$
Maximum Lead Temperature for Soldering Purposes	T_L	300			$^\circ C$

*Collector current limited by maximum Junction temperature

Thermal Characteristic

Parameter	Symbol	Tests conditions	Min	Typ	Max	Units
Off-Characteristics						
Collector-Emmitter Voltage	BV_{CES}	$I_C=500\mu A, V_{GE}=0V$	650	-	-	V

Breakdown Voltage Temperature Coefficient	$\Delta BV_{CES}/\Delta T_J$	$I_C=1\text{mA}$, referenced to 25°C	-	0.5	-	$\text{V}/^\circ\text{C}$
Zero Gate Voltage Collector Current	I_{CES}	$V_{CE}=650\text{V}$, $V_{GE}=0\text{V}$, $T_C=25^\circ\text{C}$	-		10	μA
Gate-body leakage current	I_{GES}	$V_{CE}=0\text{V}$, $V_{GE}=\pm 20\text{V}$	-	-	± 200	nA
On-Characteristics						
Gate-Emmitter Threshold Voltage	$V_{GE(th)}$	$V_{CE}=V_{GE}$, $I_C=250\mu\text{A}$	4.5	-	6.5	V
Collector-Emmitter saturation Voltage	V_{CESAT}	$V_{GE}=15\text{V}$, $I_C=20\text{A}$, $T_C=25^\circ\text{C}$	-	1.6	2.0	V
		$T_C=125^\circ\text{C}$		1.75	2.15	
		$T_C=175^\circ\text{C}$		1.9	2.3	
Short Collector current (Note 2)	$I_C(sc)$	$V_{GE}=15\text{V}$ $V_{CE}=360\text{V}$ $t_{sc}< 10\mu\text{s}$ $T_C\leq 25^\circ\text{C}$		116.7		A
Dynamic Characteristics						
Input capacitance	C_{ies}	$V_{CE}=25\text{V}$, $V_{GE}=0\text{V}$, $f=1.0\text{MHZ}$, $T_C=25^\circ\text{C}$	-	1500	-	pF
Output capacitance	C_{oes}		-	128	-	pF
Reverse transfer capacitance	C_{res}		-	28.7	-	pF
Switching Characteristics						
Turn-On delay time	$t_d(on)$	$V_{CE}=400\text{V}$, $I_C=20\text{A}$, $R_G=10\Omega$, $V_{GE}=15\text{V}$ $T_C=25^\circ\text{C}$ Inductive Load	-	16	-	ns
Turn-On rise time	t_r		-	56	-	ns
Turn-off delay time	$t_d(off)$		-	52	-	ns
Turn-off Fall time	t_f		-	82	-	ns
Turn-on energy	E_{on}		-	0.79	-	mJ
Turn-off energy	E_{off}		-	0.3	-	mJ
Total switching Energy	E_{total}		-	1.09	-	mJ
Turn-On delay time	$t_d(on)$		$V_{CE}=400\text{V}$, $I_C=20\text{A}$, $R_G=10\Omega$, $V_{GE}=15\text{V}$ $T_C=175^\circ\text{C}$ Inductive Load	-	14	-
Turn-On rise time	t_r	-		54	-	ns
Turn-off delay time	$t_d(off)$	-		76	-	ns
Turn-off Fall time	t_f	-		146	-	ns
Turn-on energy	E_{on}	-		0.8	-	mJ
Turn-off energy	E_{off}	-		0.49	-	mJ
Total switching Energy	E_{total}	-		1.3	-	mJ

Total Gate Charge	Qg	V _{CE} =400V, I _c =20A R _G =10Ω, V _{GE} =15V T _C =25°C (note3,4)	-	43.9	-	nC
Gate to emitter charge	Qge		-	10.0	-	
Gate to collector charge	Qgc		-	18.9	-	
Gate resistance	Rg	f=1MHz, open collector	-	1.8	-	Ω
Anti-Paraller Diode Characteristics and Maximum Ratings						
Diode Forward Voltage	V _F	V _{GE} =0V, I _F =20A. T _C =25°C	-	1.4	-	V
		T _C =125°C	-	1.2	-	V
		T _C =175°C	-	1.0	-	V
Diode Reverse recovery time	t _{rr}	V _{GE} =0V, I _F =20A di=dt=100A/us (note 4) T _C =25°C	-	254	-	ns
Reverse recovery charge	Q _{rr}		-	347	-	nC
Diode Reverse recovery Current	I _{rrm}		-	2.7	-	A
Diode Reverse recovery time	t _{rr}	V _{GE} =0V, I _F =20A di=dt=100A/us (note 4) T _C =175°C	-	429	-	ns
Reverse recovery charge	Q _{rr}		-	1010	-	nC
Diode Reverse recovery Current	I _{rrm}		-	4	-	A

Thermal Characteristics

Parameter	Symbol	SL20T65F	SL20T65 / SL20T65FZ	SL20T65FL	Unit
IGBT Thermal Resistance, Junction to Case	R _{th(j-c)}	3.57	0.77	0.77	°C/W
FRD Thermal Resistance, Junction to Case	R _{th(j-c)}	7.7	2.05	2.05	°C/W
Thermal Resistance, Junction to Ambient	R _{th(j-A)}	62.5	62.5	33.8	°C/W

Order Message

Order codes	Package	Packaging
SL20T65F	TO-220F	Tube
SL20T65	TO-220	Tube
SL20T65FZ	TO-263	Tube
SL20T65FL	TO-247	Tube

Electrical Characteristics (curves)

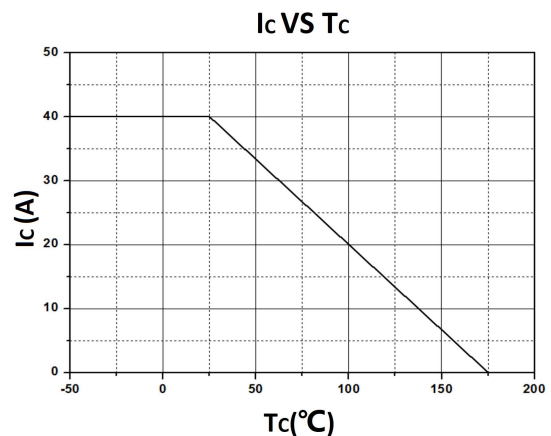
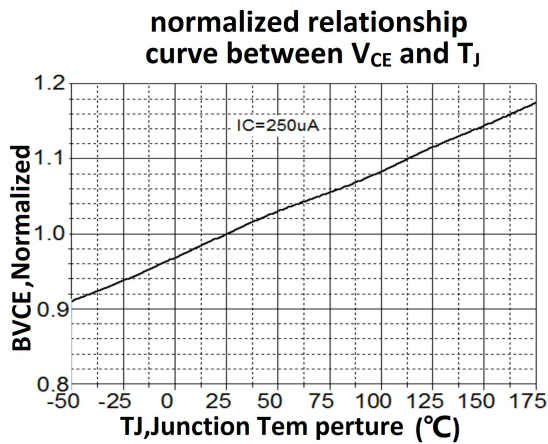
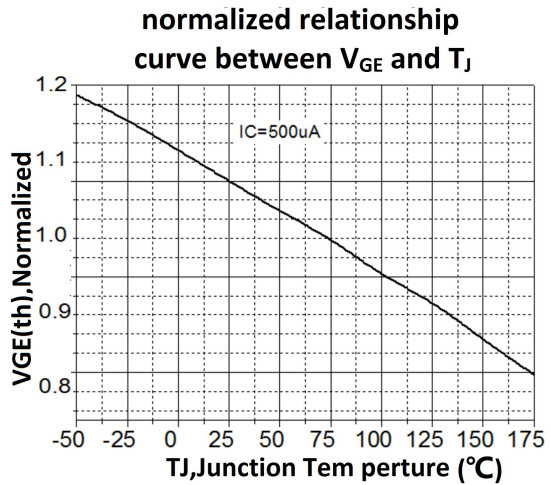
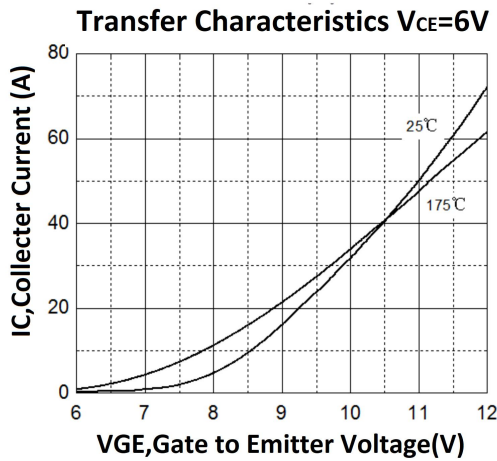
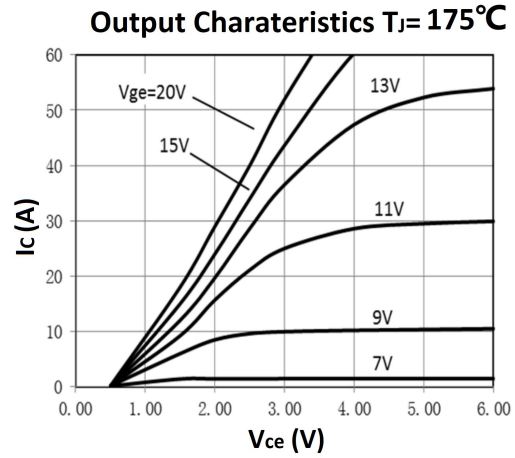
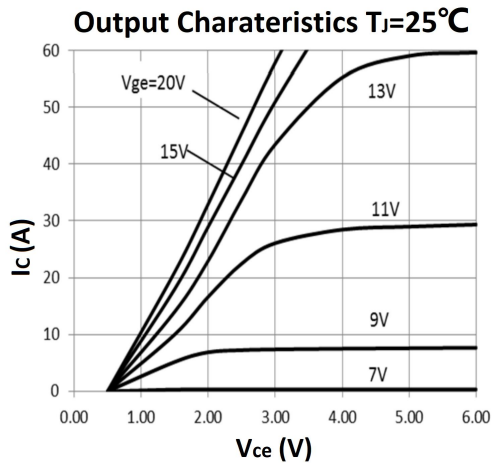

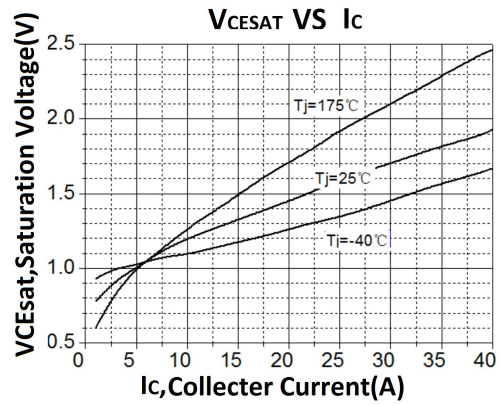
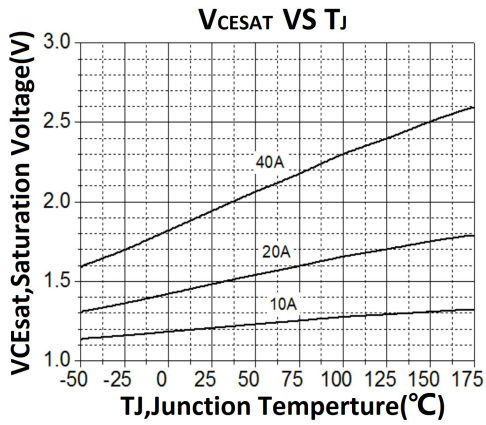

Capacitance Characteristic

V_{GE} = 0V, f = 1.0MHz

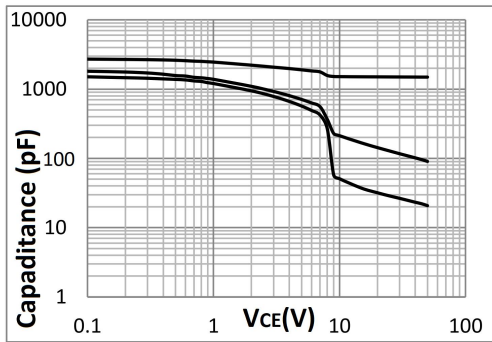

Q_g VS V_{GE}

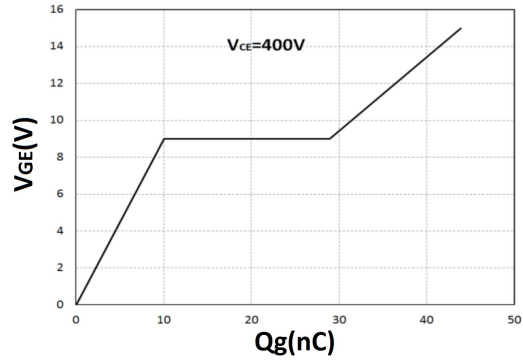

SwitchingTime VS I_c

T_J = 25°C, V_{GE} = 15V, V_{CE} = 400V, R_g = 10Ω

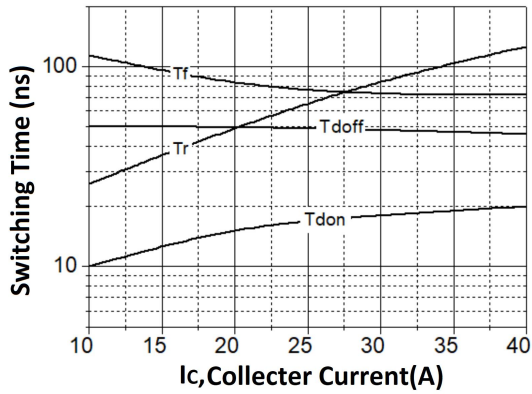

SwitchingTime VS I_c

T_J = 175°C, V_{GE} = 15V, V_{CE} = 400V, R_g = 10Ω

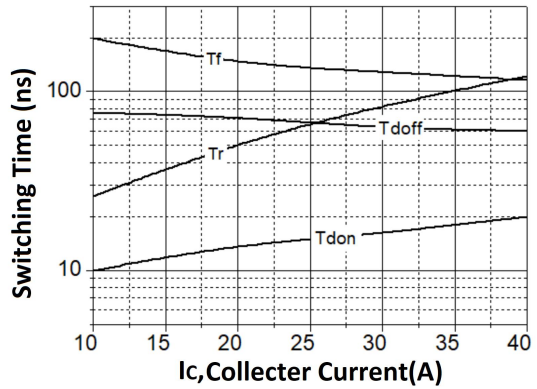

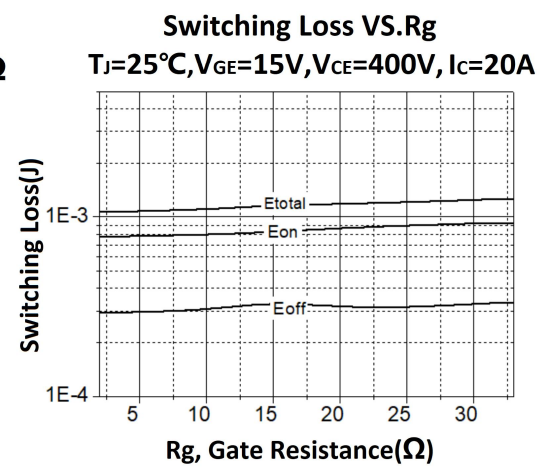
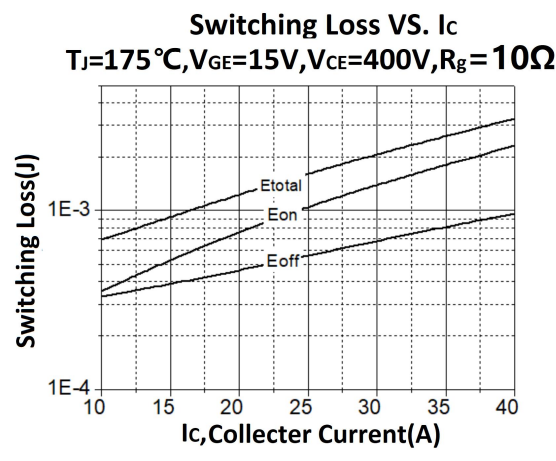
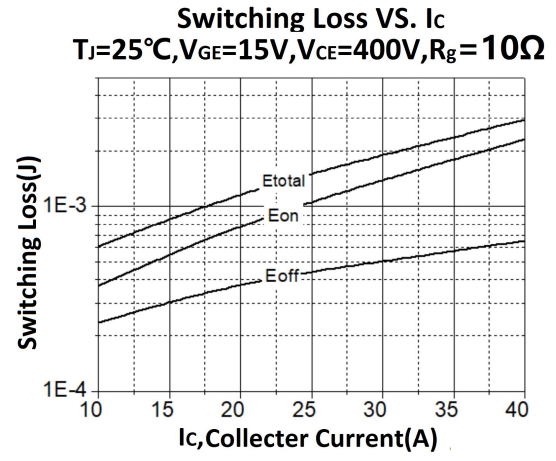
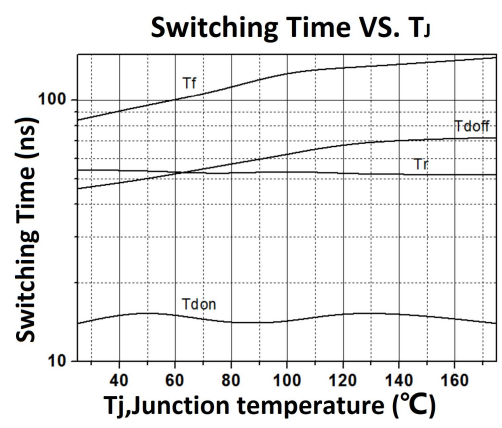
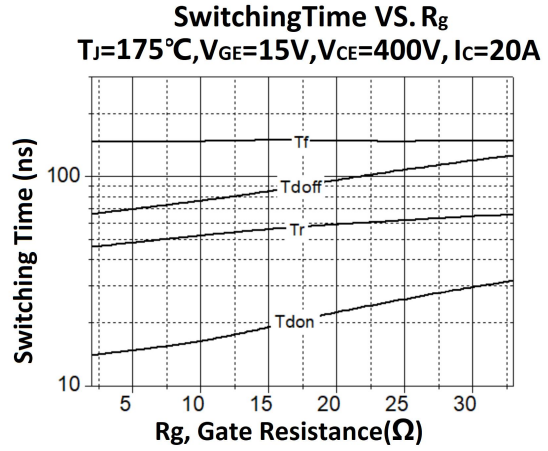
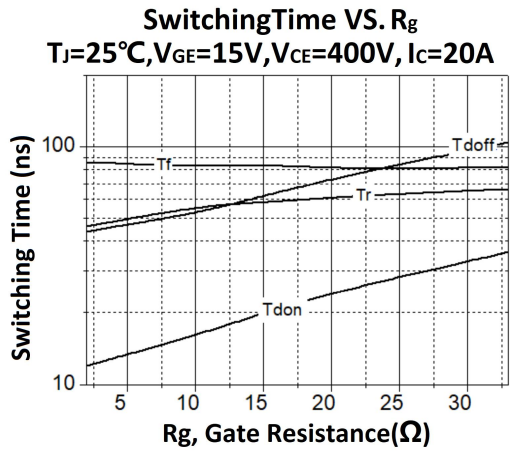

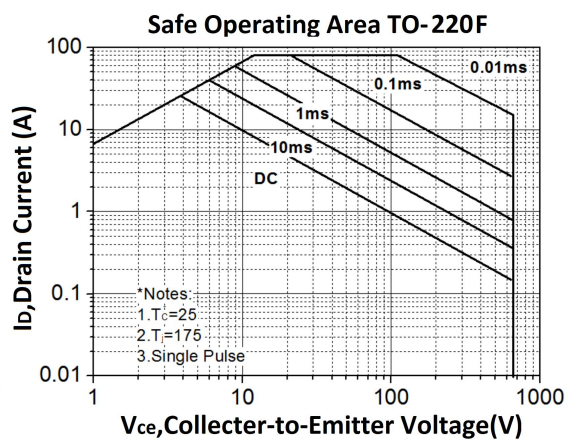
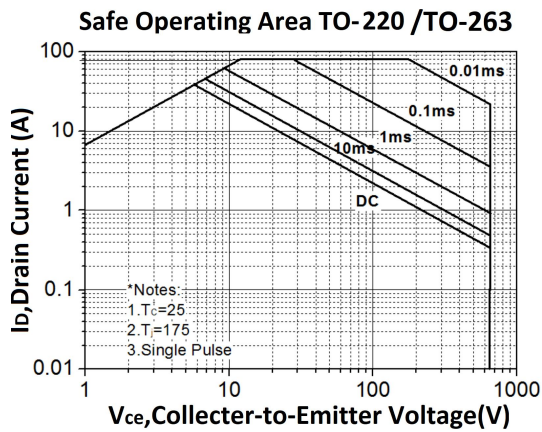
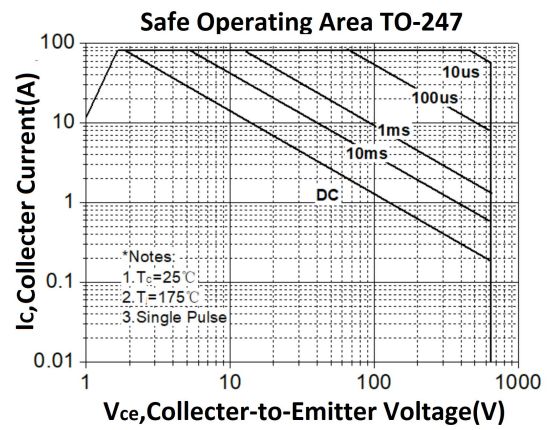
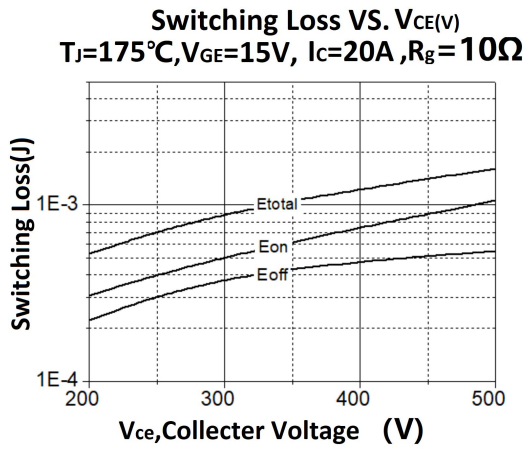
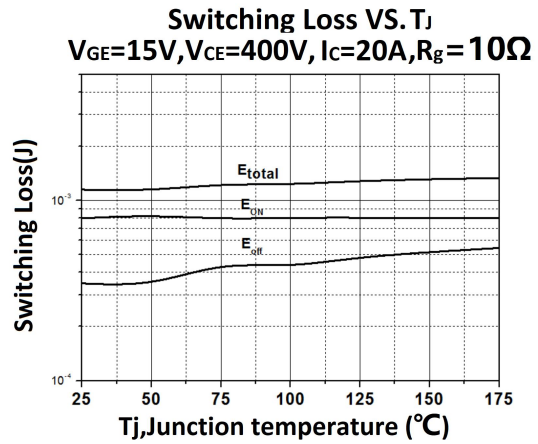
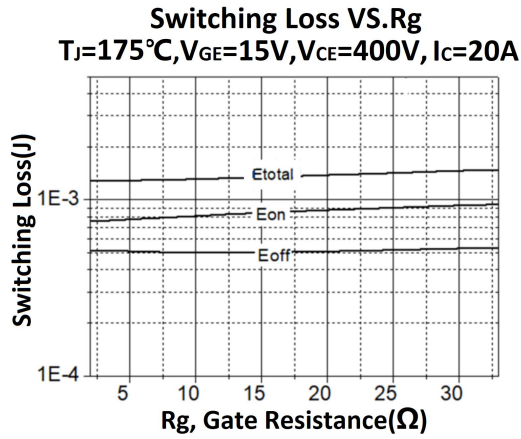

P_D VS temperature (TO-220/TO-263)

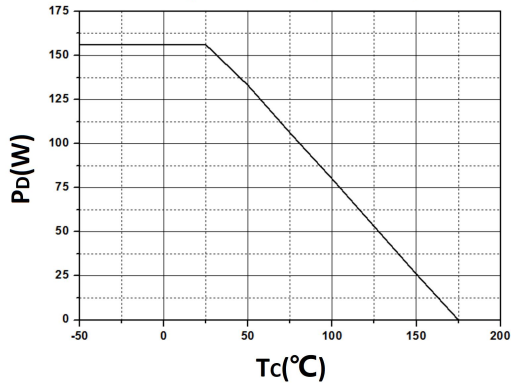

P_D VS temperature (TO-247)

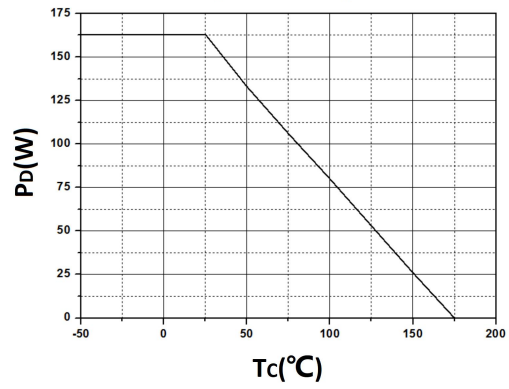

P_D VS temperature (TO-220F)

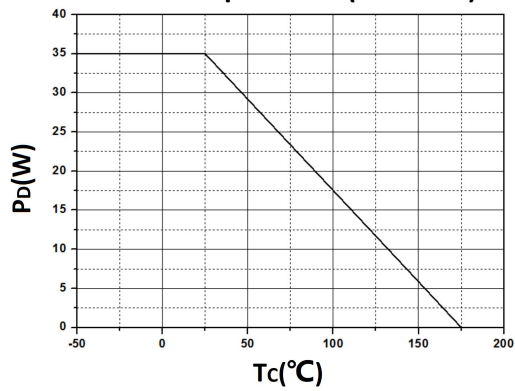

Diode Characteristic

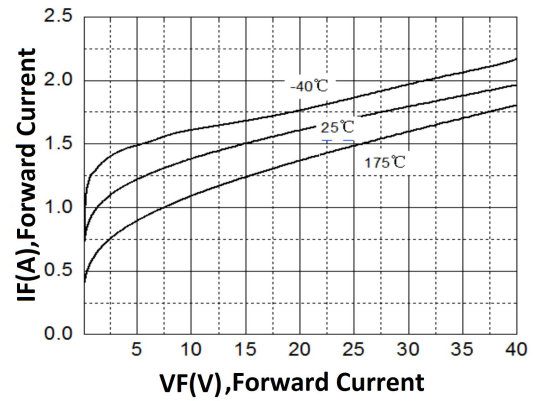

T_{rr} and di/dt

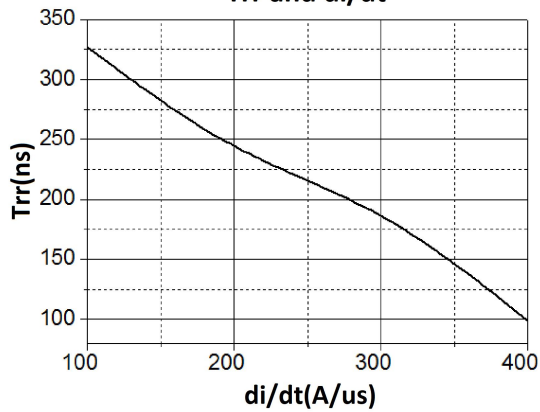

Q_{rr} and di/dt

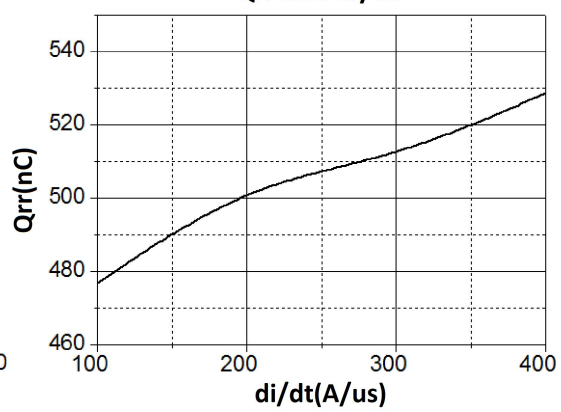

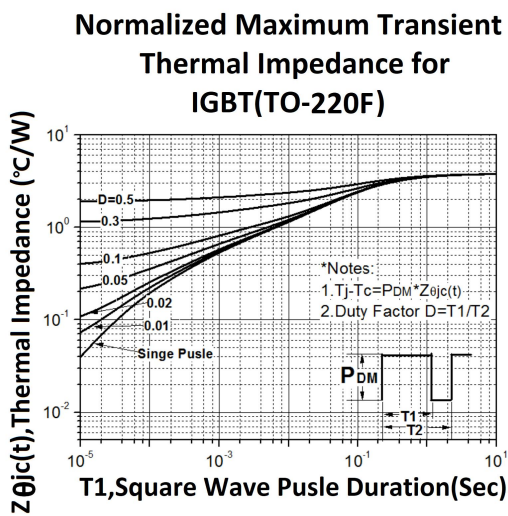
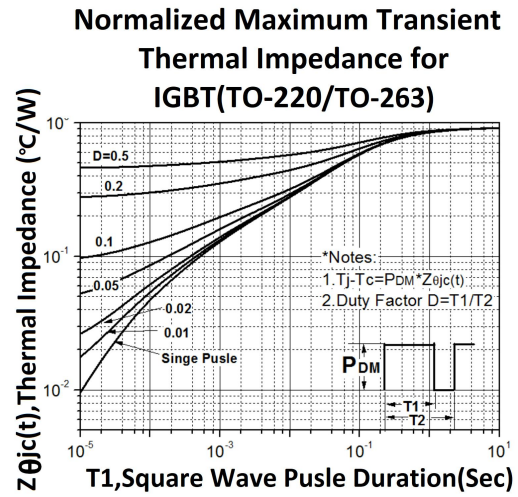
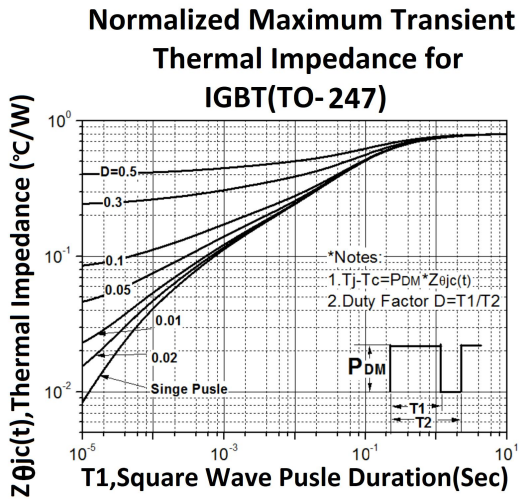
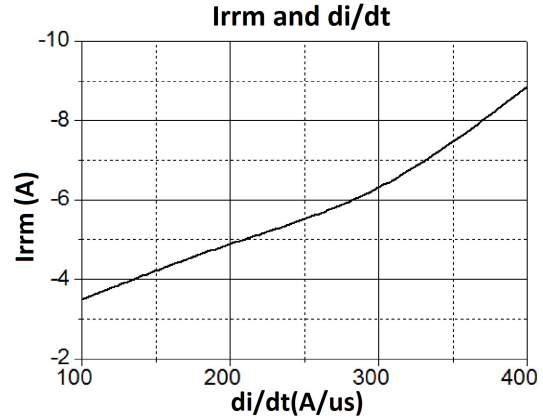
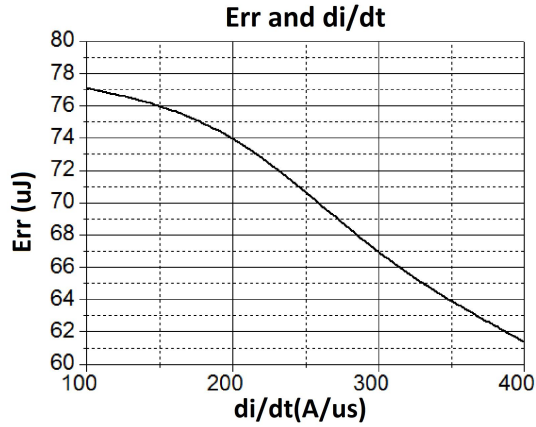

Package Mechanical DATA

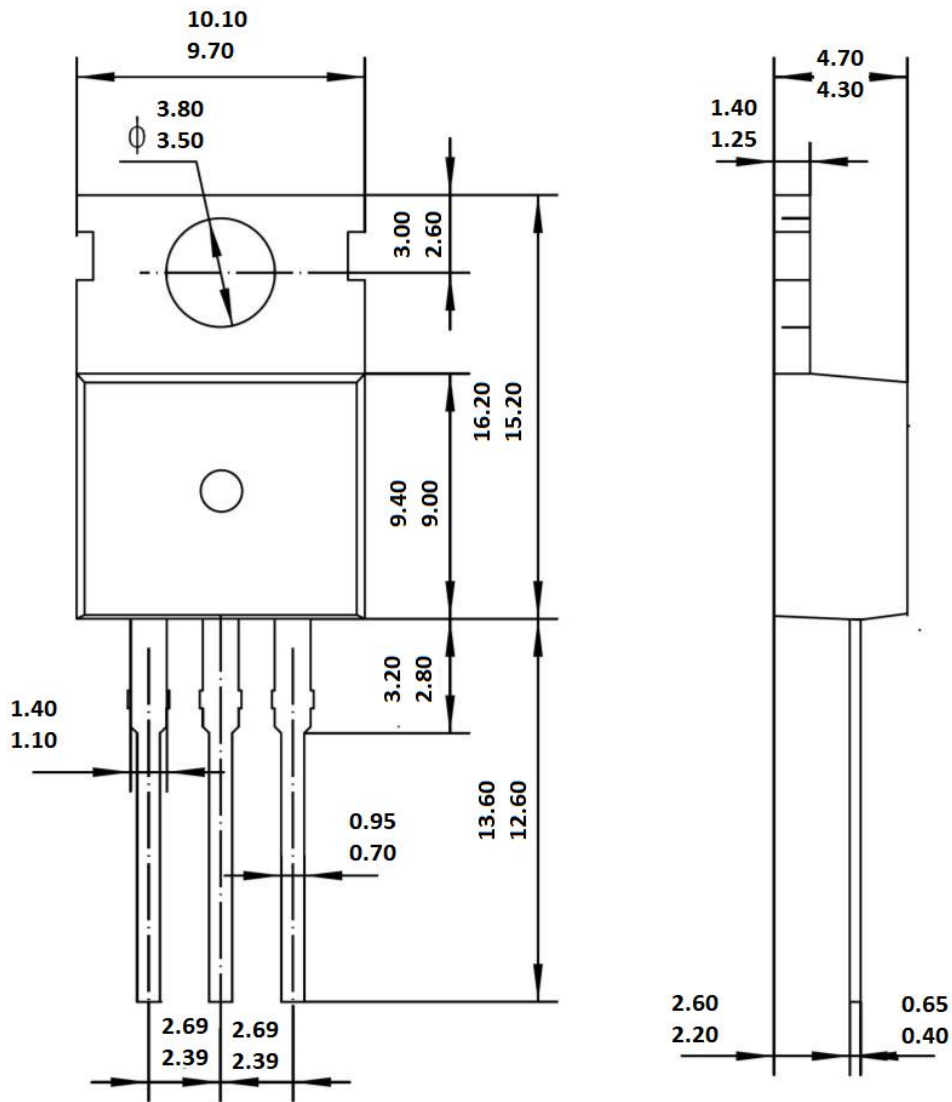

TO-220

Unit: mm

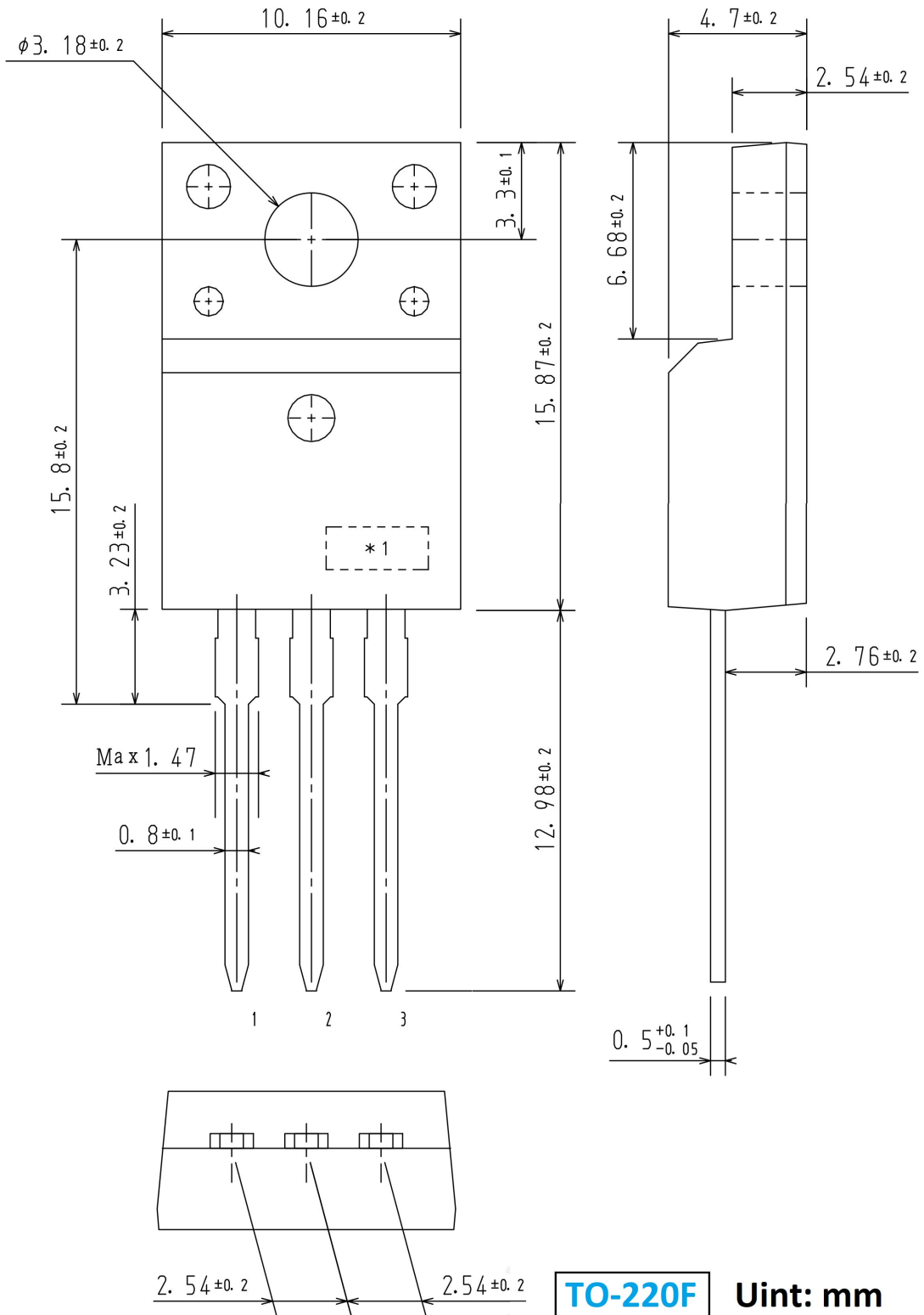

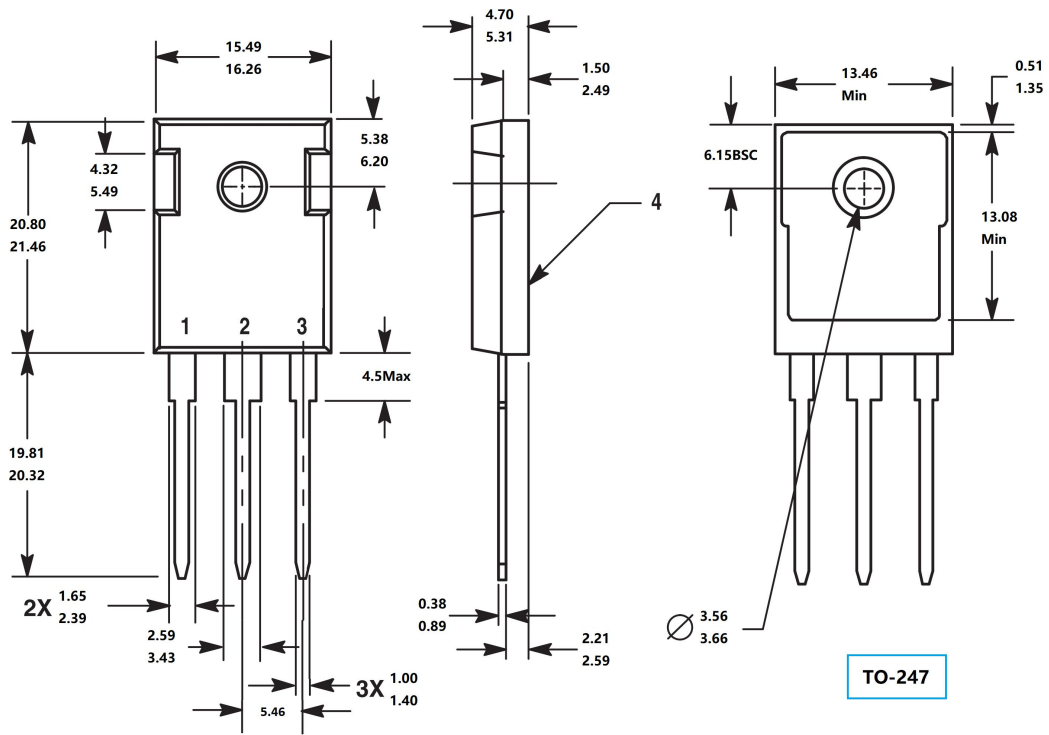

TO-247

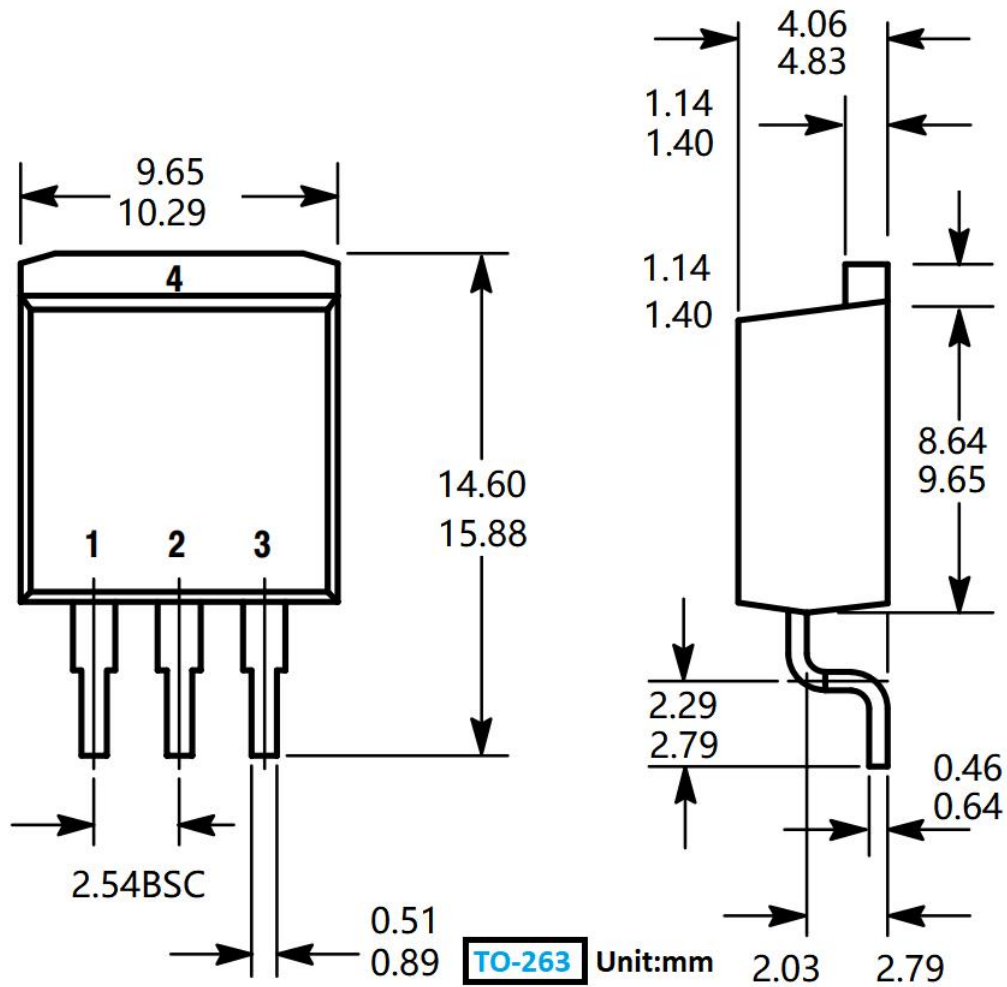

TO-263

Unit:mm

X-ON Electronics

Largest Supplier of Electrical and Electronic Components

Click to view similar products for [IGBT Transistors](#) category:

Click to view products by [SLKORMICRO](#) manufacturer:

Other Similar products are found below :

[IRG4PC30W](#) [APT20GT60BRDQ1G](#) [STGWA25H120DF2](#) [APT30GS60BRDQ2G](#) [TIG058E8-TL-H](#) [IDW40E65D2](#) [STGB40V60F](#)
[STGWA25H120F2](#) [NGTB75N65FL2WAG](#) [2MBI150VA-060-50](#) [NTE3320](#) [FGD3040G2-F085](#) [FGD3440G2-F085](#) [STGW80H65DFB-4](#)
[AFGY160T65SPD-B4](#) [IGW30N60TP](#) [IGW40N60TP](#) [IGW50N60TP](#) [IHW30N65R5](#) [IKFW40N60DH3E](#) [IKP15N65H5](#) [IKQ100N60T](#)
[IKQ120N60T](#) [IKW30N65WR5](#) [IKW75N60H3](#) [IKZ50N65NH5](#) [IKZ75N65NH5](#) [FGD3040G2-F085C](#) [FGH4L50T65SQD](#) [FGHL40T65MQDT](#)
[FGHL50T65MQD](#) [FGHL50T65MQDTL4](#) [FGHL75T65LQDT](#) [FGHL75T65MQD](#) [FGHL75T65MQDT](#) [FGHL75T65MQDTL4](#)
[FGY75T120SWD](#) [EL3120S1\(TA\)\(SAS\)-V](#) [IHW15N120E1](#) [IKQ75N120CS6](#) [IKW50N65WR5](#) [SL15T65FK](#) [KGF50N65KDF-U/H](#)
[IHF40N65R5S](#) [IKW08N120CS7XKSA1](#) [IKQ75N120CH3](#) [IHW30N160R5](#) [SGM100HF12A1TFD](#) [CRG50T60AK3SD](#) [CRG40T60AN3S](#)