

N-Channel Power MOSFET

General Features

- $V_{DS} = 20V, I_D = 2.8 A$
 $R_{DS(ON)} < 85m\Omega @ V_{GS}=2.5V$
 $R_{DS(ON)} < 45m\Omega @ V_{GS}=4.5V$
- High power and current handling capability
- Lead free product is acquired
- Surface mount package

Application

- DC/DC Converter
- Load switch

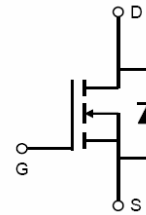

Schematic diagram

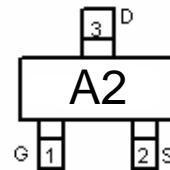

Marking and pin assignment



SOT-23 top view

Absolute Maximum Ratings ($T_A=25^\circ C$ unless otherwise noted)

Parameter	Symbol	Limit	Unit
Drain-Source Voltage	V_{DS}	20	V
Gate-Source Voltage	V_{GS}	± 12	V
Drain Current-Continuous	I_D	2.8	A
Drain Current-Pulsed ^(Note 1)	I_{DM}	12	A
Maximum Power Dissipation	P_D	0.4	W
Operating Junction and Storage Temperature Range	T_J, T_{STG}	-55 To 150	$^\circ C$

Thermal Characteristic

Thermal Resistance, Junction-to-Ambient ^(Note 2)	$R_{\theta JA}$	312.5	$^\circ C/W$
---	-----------------	-------	--------------

Electrical Characteristics ($T_A=25^\circ C$ unless otherwise noted)

Parameter	Symbol	Condition	Min	Typ	Max	Unit
Off Characteristics						
Drain-Source Breakdown Voltage	BV_{DSS}	$V_{GS}=0V, I_D=250\mu A$	20	-	-	V
Zero Gate Voltage Drain Current	I_{DSS}	$V_{DS}=20V, V_{GS}=0V$	-	-	1	μA

Parameter	Symbol	Condition	Min	Typ	Max	Unit
Gate-Body Leakage Current	I_{GSS}	$V_{GS}=\pm 12V, V_{DS}=0V$	-	-	± 100	nA
On Characteristics <small>(Note 3)</small>						
Gate Threshold Voltage	$V_{GS(th)}$	$V_{DS}=V_{GS}, I_D=50\mu A$	0.65	0.95	1.2	V
Drain-Source On-State Resistance	$R_{DS(ON)}$	$V_{GS}=4.5V, I_D=3.6A$	-	35	45	m Ω
		$V_{GS}=2.5V, I_D=3.1A$	-	45	85	m Ω
Forward Transconductance	g_{FS}	$V_{DS}=5V, I_D=3.6A$	-	8	-	S
Dynamic Characteristics <small>(Note 4)</small>						
Input Capacitance	C_{iss}	$V_{DS}=10V, V_{GS}=0V,$ $F=1.0MHz$	-	300	-	PF
Output Capacitance	C_{oss}		-	120	-	PF
Reverse Transfer Capacitance	C_{rss}		-	80	-	PF
Switching Characteristics <small>(Note 4)</small>						
Turn-on Delay Time	$t_{d(on)}$	$V_{DD}=10V,$ $R_L=5.5\Omega, I_D \approx 3.6A,$ $V_{GEN}=4.5V, R_g=6\Omega$	-	7	15	nS
Turn-on Rise Time	t_r		-	55	80	nS
Turn-Off Delay Time	$t_{d(off)}$		-	16	60	nS
Turn-Off Fall Time	t_f		-	10	25	nS
Total Gate Charge	Q_g	$V_{DS}=10V, I_D=3.6A,$ $V_{GS}=4.5V$	-	4.0	10	nC
Gate-Source Charge	Q_{gs}		-	0.65	-	nC
Gate-Drain Charge	Q_{gd}		-	0.15	-	nC
Drain-Source Diode Characteristics						
Diode Forward Voltage <small>(Note 3)</small>	V_{SD}	$V_{GS}=0V, I_S=0.94A$	-	0.76	1.2	V
Diode Forward Current <small>(Note 2)</small>	I_S		-	-	3	A

Notes:

1. Repetitive Rating: Pulse width limited by maximum junction temperature.
2. Surface Mounted on FR4 Board, $t \leq 10$ sec.
3. Pulse Test: Pulse Width $\leq 300\mu s$, Duty Cycle $\leq 2\%$.
4. Guaranteed by design, not subject to production

Typical Electrical and Thermal Characteristics

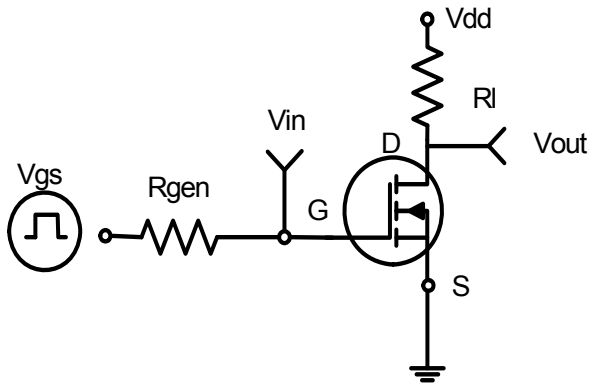

Figure 1: Switching Test Circuit

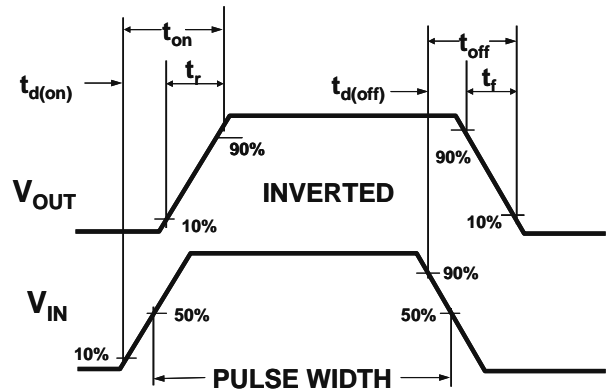

Figure 2: Switching Waveforms

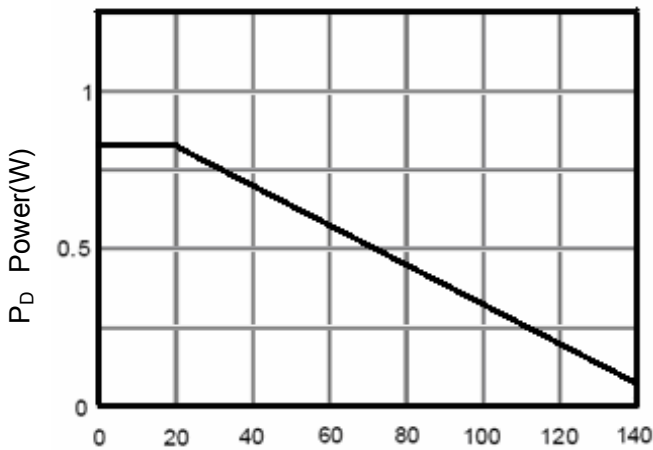

Figure 3 Power Dissipation

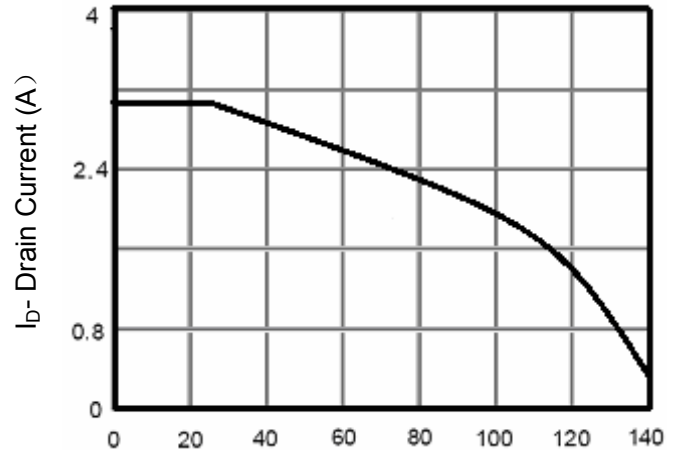

Figure 4 Drain Current

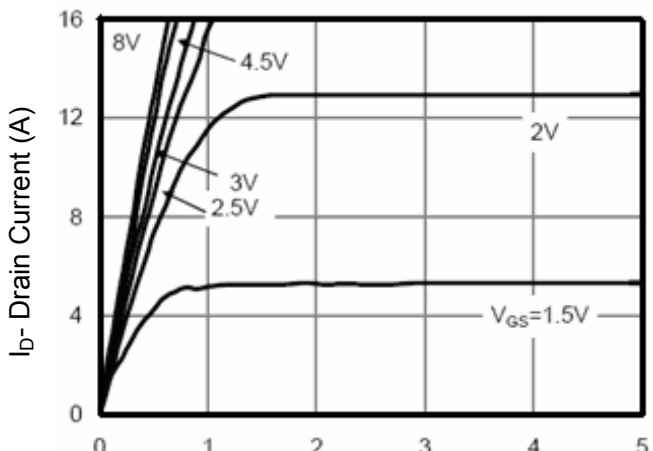

Figure 5 Output Characteristics

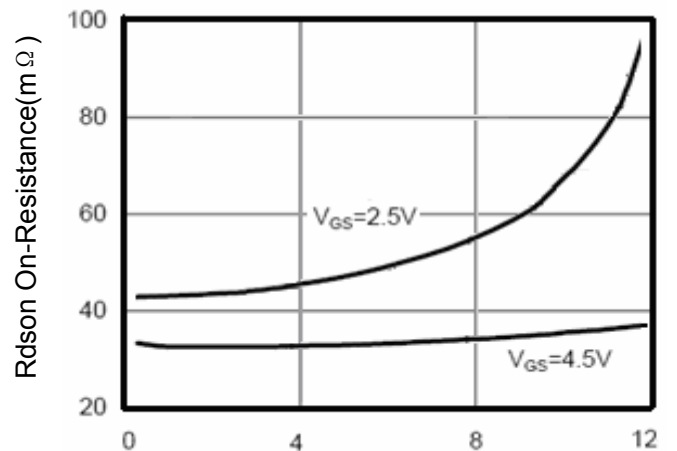
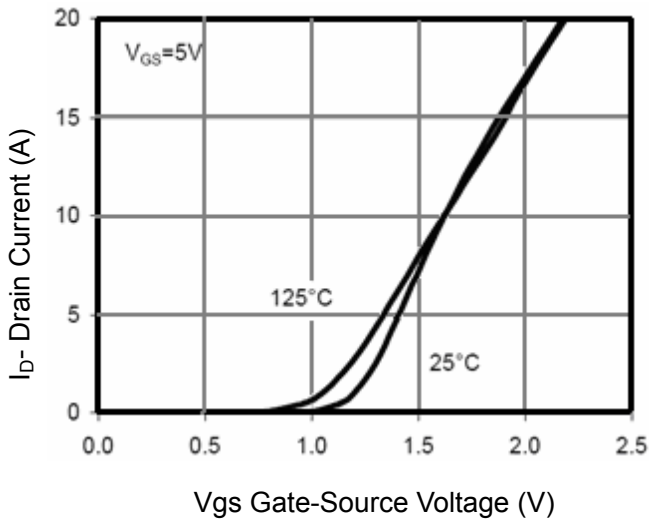
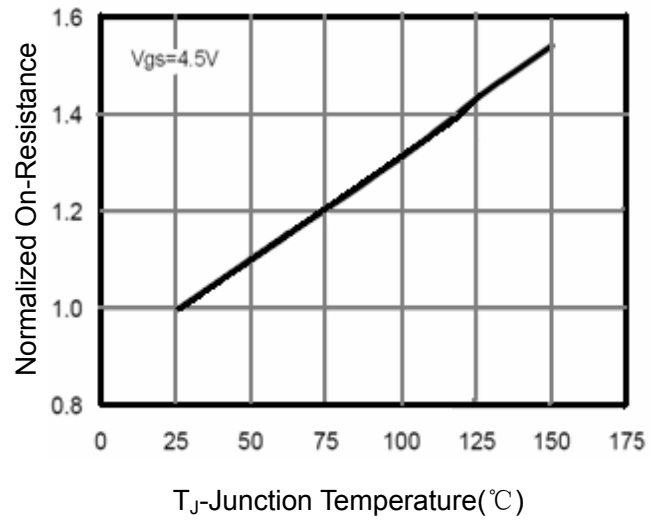

Figure 6 Drain-Source On-Resistance



Vgs Gate-Source Voltage (V)
Figure 7 Transfer Characteristics



T_J -Junction Temperature(°C)
Figure 8 Drain-Source On-Resistance

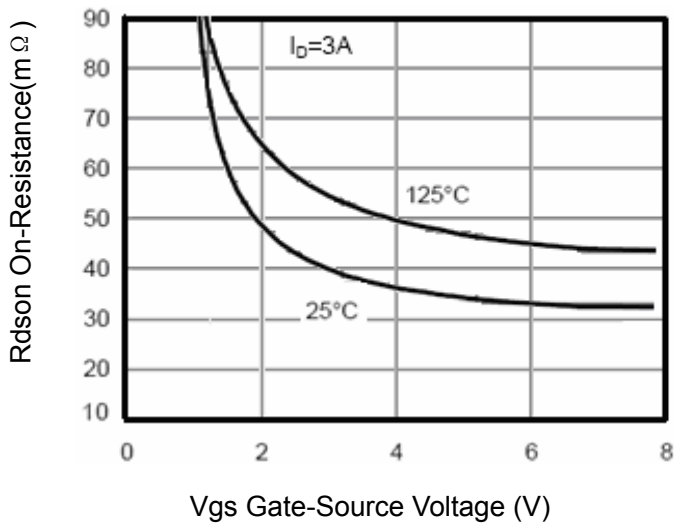

Vgs Gate-Source Voltage (V)
Figure 9 Rdson vs Vgs

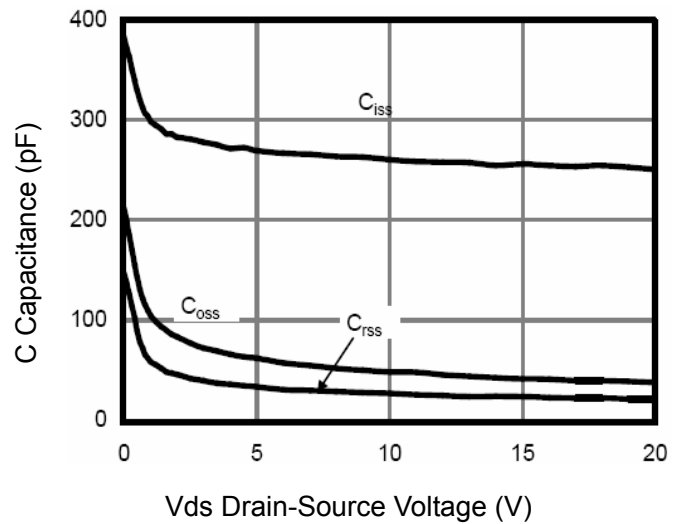

Vds Drain-Source Voltage (V)
Figure 10 Capacitance vs Vds

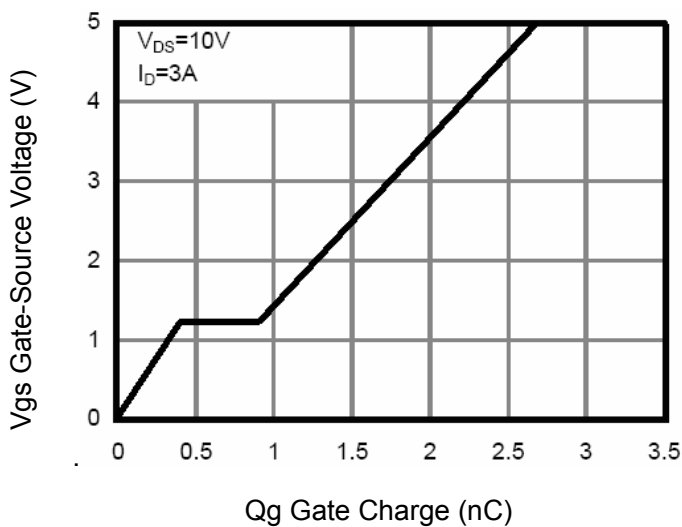

Qg Gate Charge (nC)
Figure 11 Gate Charge

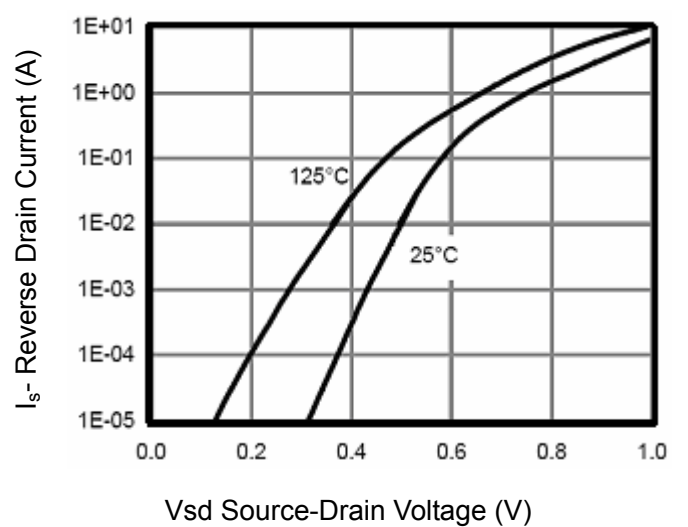

Vsd Source-Drain Voltage (V)
Figure 12 Source- Drain Diode Forward

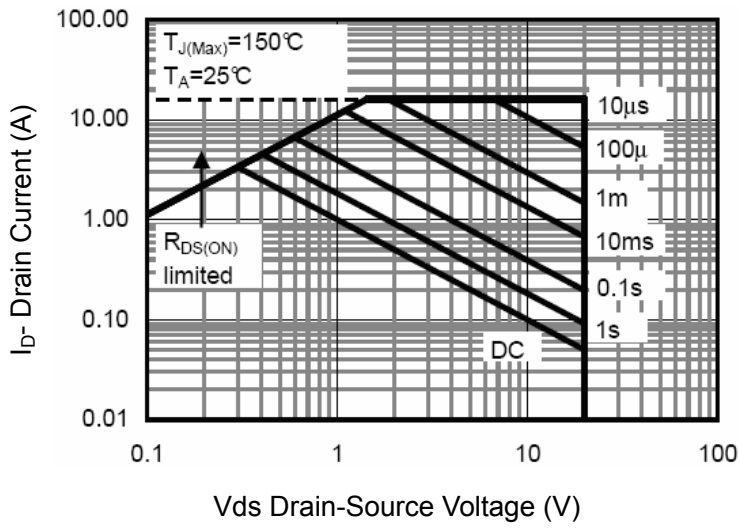

Figure 13 Safe Operation Area

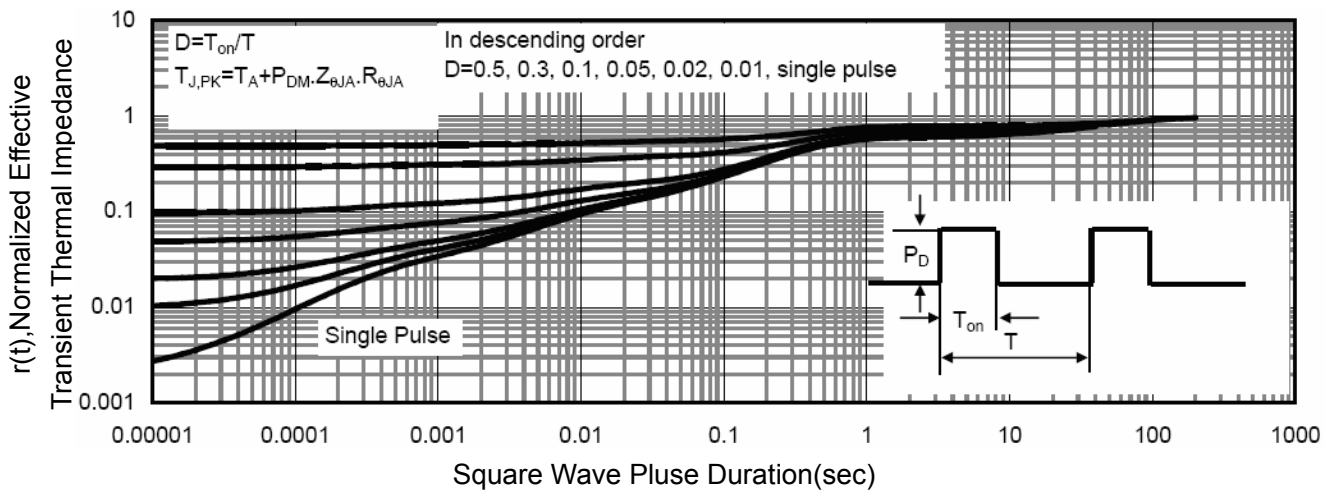
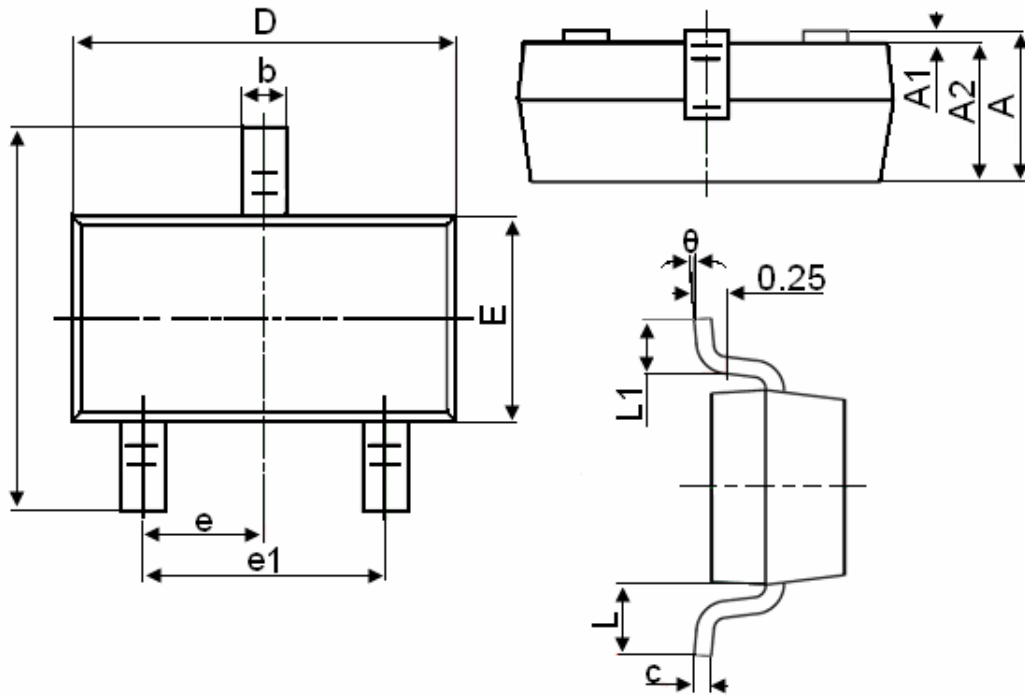

Figure 14 Normalized Maximum Transient Thermal Impedance

SOT-23 Package Information

Symbol	Dimensions in Millimeters	
	MIN.	MAX.
A	0.900	1.150
A1	0.000	0.100
A2	0.900	1.050
b	0.300	0.500
c	0.080	0.150
D	2.800	3.000
E	1.200	1.400
E1	2.250	2.550
e	0.950TYP	
e1	1.800	2.000
L	0.550REF	
L1	0.300	0.500
θ	0°	8°

X-ON Electronics

Largest Supplier of Electrical and Electronic Components

Click to view similar products for [MOSFET](#) category:

Click to view products by [SLKORMICRO](#) manufacturer:

Other Similar products are found below :

[614233C](#) [648584F](#) [FDPF9N50NZ](#) [IRFD120](#) [IRFF430](#) [JANTX2N5237](#) [2N7000](#) [FCA20N60_F109](#) [FDZ595PZ](#) [2SK2267\(Q\)](#) [2SK2545\(Q,T\)](#)
[405094E](#) [423220D](#) [MIC4420CM-TR](#) [VN1206L](#) [614234A](#) [715780A](#) [SSM6J414TU,LF\(T](#) [751625C](#) [PSMN4R2-30MLD](#)
[TK31J60W5,S1VQ\(O](#) [2SK2614\(TE16L1,Q\)](#) [DMN1017UCP3-7](#) [EFC2J004NUZTDG](#) [FCAB21350L1](#) [P85W28HP2F-7071](#) [DMN1053UCP4-7](#)
[NTE2384](#) [NTE2969](#) [NTE6400A](#) [DMN61D9UWQ-13](#) [US6M2GTR](#) [DMN31D5UDJ-7](#) [SSM6P54TU,LF](#) [DMP22D4UFO-7B](#)
[IPS60R3K4CEAKMA1](#) [DMN1006UCA6-7](#) [DMN16M9UCA6-7](#) [STF5N65M6](#) [STU5N65M6](#) [C3M0021120D](#) [DMN13M9UCA6-7](#)
[BSS340NWH6327XTSA1](#) [MCM3400A-TP](#) [DMTH10H4M6SPS-13](#) [IPS60R1K0PFD7SAKMA1](#) [IPS60R360PFD7SAKMA1](#)
[IPS60R600PFD7SAKMA1](#) [IPS60R210PFD7SAKMA1](#) [DMN2990UFB-7B](#)