

## SL3027 Series- High input Voltage Linear Li-Ion Battery Charger

### GENERAL DESCRIPTION

The SL3027 Series is a complete constant current & constant voltage linear charger for single cell lithium-ion batteries. Its DFN package and low external component counts make the SL3027 Series ideally suited for portable applications. Furthermore, the SL3027 Series is specifically designed to work within USB power specifications.

No external sense resistor is needed, and no blocking diode is required due to the internal MOSFET architecture. The charge voltage is fixed at 4.2V/4.3V/4.35V/4.4V, and the charge current can be programmed externally with a single resistor. The SL3027 Series automatically terminates the charge cycle when the charge current drops to 1/10 the programmed value after the final float voltage is reached.

When the input supply (wall adapter or USB supply) is removed, the SL3027 Series automatically enters a low current state, dropping the battery drain current to less than 2uA. The SL3027 Series can be put into shutdown mode, reducing the supply current to 50uA.

Under-voltage lockout, automatic recharge and two status pins to indicate charge and charge termination.

### FEATURES

- 30V standoff input voltage at VCC pin
- Programmable Charge Current Up to 200mA
- No MOSFET, Sense Resistor or Blocking Diode Required
- Complete Linear Charger in DFN Package for single Cell Lithium-Ion Batteries
- Charges Single Cell Li-Ion Batteries Directly from USB Port
- Preset 4.2V/4.3V/4.35V/4.4V Charge Voltage with  $\pm 1\%$  Accuracy
- Charge Current Monitor Output for Gas Gauging
- Automatic Recharge
- Charge state pairs of output, no battery and fault status display
- CC/10 Charge Termination
- 50uA Supply Current in Shutdown
- 2.9V Trickle Charge Threshold
- Soft-Start Limits Inrush Current
- ESD HBM 2KV
- Available in DFN2x2-8 Package

### APPLICATIONS

- Cellular Telephones, PDAs, MP3 /MP4 Players
- E-cigarettes
- Bluetooth
- GPS Applications

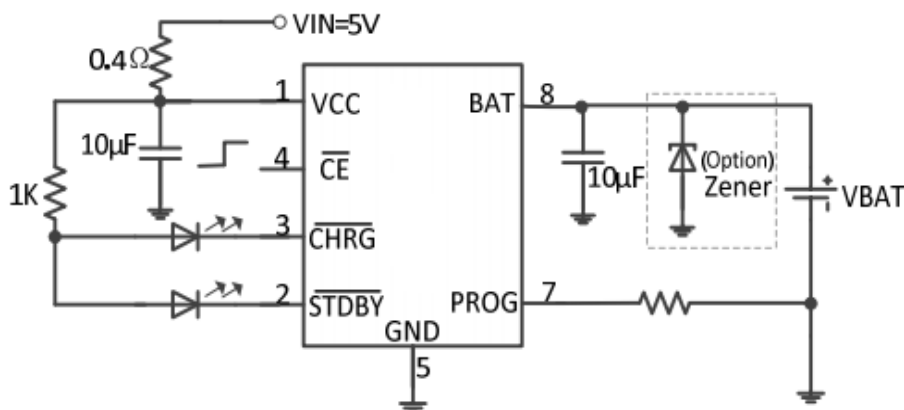

Figure1 .Typical Application Circuit

## ORDERING INFORMATION

PART NUMBER (note1)	VBAT	"CE" PIN Enable Logic	MARK (note2)
SL3027A	4.2V	Low Enable	3027AYW
SL3027B	4.3V	Low Enable	3027BYW
SL3027C	4.35V	Low Enable	3027CYW
SL3027D	4.4V	Low Enable	3027DYW

Note1: In SL3027X description, X may be A or B or C or D

Note2: "YW" is manufacture date code, "Y" means the year, "W" means the week

## PIN CONFIGURATION

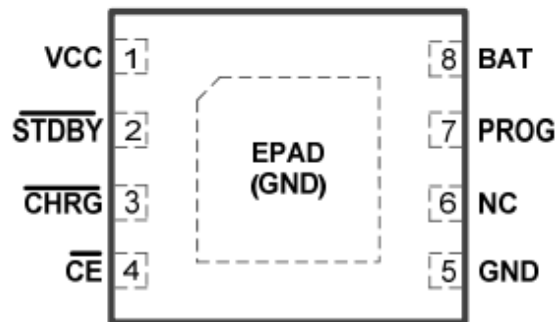

Figure 2. PIN Configuration (DFN2x2-8)

## PIN DESCRIPTION

PIN NUMBER	PIN NAME	PIN DESCRIPTION
1,	VCC	Positive Input Supply Voltage.
2	STDBY	The completion of battery charging instructions side.
3	CHRG	Open-Drain Charge Status Output.
4	CE	Chip enable input. SL3027X's CE is Low Enable,
5	GND	Ground
6	NC	No Connection.
7	PROG	Charge Current Program, Charge Current Monitor and Shut down Pin.
8	BAT	Charge Current Output.
9	EPAD	Ground and EPAD

## ABSOLUTE MAXIMUM RATINGS

(Note: Do not exceed these limits to prevent damage to the device. Exposure to absolute maximum rating conditions for long periods may affect device reliability.)

PARAMETER	VALUE	UNIT
Input Supply Voltage VCC	VSS-0.3 ~ VSS+30	V
PROG pin Voltage Vprog, CE pin Voltage Ven	VSS-0.3 ~ 10	V
BAT pin Voltage Vbat	VSS-0.3 ~ 11	V
CHRG, STDBY pin Voltage Vchrg	VSS-0.3 ~ 10	V
BAT pin Currentibat	0.25	A
PROG pin CurrentIprog	0.25	mA
Operating Ambient Temperature	-40 to 85	°C
Maximum Junction Temperature	150	°C
Storage Temperature	-55 to 150	°C
Lead Temperature (Soldering, 10 sec)	260	°C

## ELECTRICAL CHARACTERISTICS

(V<sub>CC</sub> = 5.0V, V<sub>bat</sub>=3.5V T<sub>A</sub>= 25°C unless otherwise specified)

PARAMETER	SYMBOL	TEST CONDITIONS	MIN	TYP	MAX	UNIT
Input Voltage Range			4.25		26	V
Input over Voltage protection	V <sub>ovp</sub>			6.8		V
The Hysteresis Voltage of V <sub>ovp</sub>				0.4		V
Input Voltage Range			4.25		6	V
Input supply current	I <sub>cc</sub>	Charge mode, R <sub>PROG</sub> =10K		350	2000	µA
		Standby mode, V <sub>bat</sub> =4.3V		150	500	µA
		Shutdown mode(V <sub>cc</sub> <V <sub>bat</sub> or V <sub>cc</sub> <V <sub>uv</sub> )		50	200	µA
BAT pin Current	I <sub>bat</sub>	R <sub>PROG</sub> =200k, Current mode	4	5	6	mA
		R <sub>PROG</sub> =100k, Current mode	8	9.5	11	mA
		R <sub>PROG</sub> =10k, Current mode	85	95	105	mA
		Standby mode, V <sub>bat</sub> =4.3V	0	-2.5	-6	µA
		Shutdown mode		1	2.5	µA
		Sleep mode, V <sub>cc</sub> =0V		0.3	2.5	µA
Regulated Charge Voltage( SL3027A)	V <sub>float</sub>	0°C ≤ T <sub>A</sub> ≤ 85°C, I <sub>charge</sub> = 40mA	4.158	4.2	4.242	V
Regulated Charge Voltage( SL3027B)			4.257	4.3	4.343	V

Regulated Charge Voltage( SL3027C)			4.307	4.35	4.394	V
Regulated Charge Voltage( SL3027D)			4.356	4.4	4.444	V
PROG pin Voltage	Vprog	R <sub>PROG</sub> =10k, Current mode	0.93	1.0	1.07	V
Trickle charge current	Itrikl	V <sub>bat</sub> <V <sub>trikl</sub> , R <sub>prog</sub> =10k	8.5	9.5	10.5	mA
Trickle charge Threshold Voltage	Vtrikl	R <sub>PROG</sub> =10K, V <sub>bat</sub> Rising	2.7	2.9	3.1	V
Trickle voltage hysteresis voltage	V <sub>trhys</sub>	R <sub>PROG</sub> =10K	0.08	0.12	0.16	V
Recharge Battery threshold Voltage	Δ Vrecg	V <sub>FLOAT</sub> - V <sub>RECHRG</sub>		105	150	mV
Under voltage Lockout Threshold	V <sub>UVLO</sub>	BAT = 3.5V, IN Rising	3.05	3.4	3.75	V
VCC under voltage lockout hysteresis	V <sub>uvhys</sub>			600		mV
CHRG pin Output low voltage	V <sub>chrg</sub>	I <sub>chrg</sub> =5mA		1.2	2	V
STDBY pin Output low voltage	V <sub>stdby</sub>	I <sub>stdby</sub> =5mA		1.2	2	V
Enable Threshold		V <sub>CC</sub> =4.25V~6.5V	0.3	1	1.5	V
Enable Leakage Current			-0.1		+0.1	uA
Thermal Shutdown Temperature	T <sub>SHDN</sub>			140		°C
Thermal Shutdown Hysteresis	ΔT <sub>SHDN</sub>			20		°C

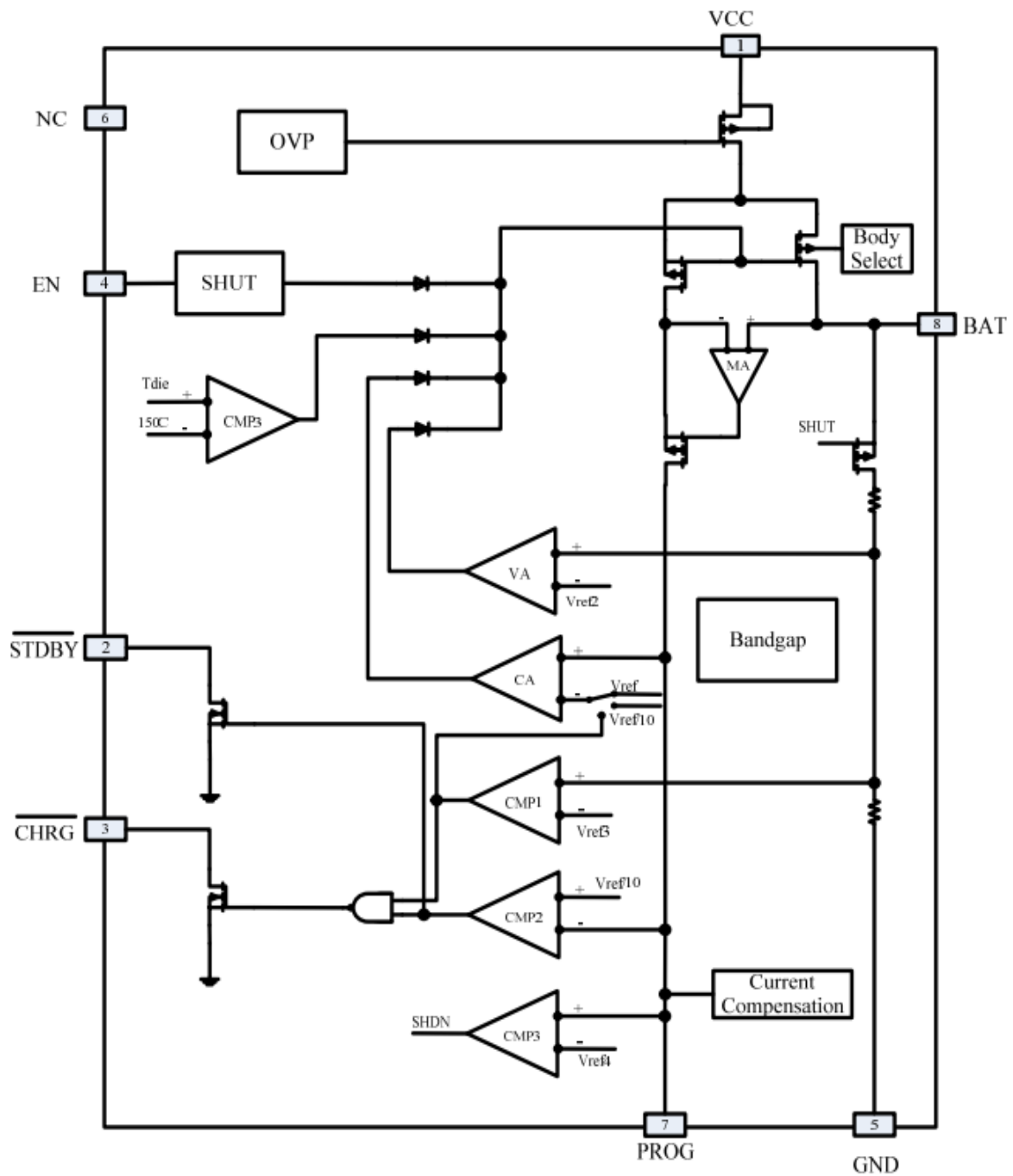

**Figure3 Block Diagram**

## **PIN FUNCTION**

**VCC (PIN 1):** Positive Input Supply Voltage.

**STDBY (PIN 2):** The completion of battery charging instructions side.

When the battery charge is complete,  $\overline{\text{STDBY}}$  pulled low by internal switches, indicating the completion of charging. In addition,  $\overline{\text{STDBY}}$  pin will be in a high-impedance state.

**CHRG (PIN 3):** Open-Drain Charge Status Output.

When the battery is charging, the  $\overline{\text{CHRG}}$  pin is pulled low by an internal N-channel MOSFET. When the charge cycle is completed,  $\overline{\text{CHRG}}$  pin will be in a high-impedance state.

**CE (PIN 4):** Chip enable input.

SL3027X Low Enable, CE pin can be TTL or CMOS level-level driver.

CE pin is low voltage tolerance pin and can't connect with VCC directly.

**GND (PIN 5):** Ground.

**NC (PIN 6):** No Connection.

**PROG (PIN 7):** Charge Current Program, Charge Current Monitor and Shutdown Pin.

The charge current is programmed by connecting a 1% resistor, RPROG, to ground. When charging in constant-current mode, this pin serves to 1V. In all modes, the voltage on this pin can be used to measure the charge current using the following formula:

$$\text{IBAT} = (\text{VPROG}/\text{RPROG}) \times 950.$$

The PROG pin can also be used to shut down the charger. Disconnecting the program resistor from ground allows a compensated current to pull the PROG pin high. When it reaches the 1.21V shutdown threshold voltage, the charger enters shutdown mode, charging stops and the input supply current drops to 50uA. Reconnecting RPROG to ground will return the charger to normal operation.

**BAT (PIN 8):** Charge Current Output.

Provides charge current to the battery and regulates the final float voltage to 4.2V/4.3V/4.35V/4.4V. An internal precision resistor divider from this pin sets the float voltage which is disconnected in shutdown mode.



## OPERATION

### CHARGE CYCLE OVERVIEW

When a battery charge cycle begins, the battery charger first determines if the battery is deeply discharged. If the battery voltage is below  $V_{trikl}$ , typically 2.9V, an automatic trickle charge feature sets the battery charge current to 10% of the full-scale value.

Once the battery voltage is above 2.9V, the battery charger begins charging in constant-current mode. When the battery voltage approaches the 4.2V/4.3V/4.35V/4.4V required to maintain a full charge, otherwise known as the float voltage, the charge current begins to decrease as the SL3027 Series switches into constant-voltage mode.

### TRICKLE CHARGE AND CHARGE TERMINATION

Any time the battery voltage is below  $V_{trikl}$ , the charger goes into trickle charge mode and reduces the charge current to 10% of the full-scale current. If for any reason the battery voltage rises above  $V_{trikl}$ , the charger will resume charging. When the battery is charging, the  $\overline{CHRG}$  pin is pulled low by an internal N-channel MOSFET. When the charge cycle is completed,  $\overline{CHRG}$  pin will be in a high-impedance state.

When the battery voltage reach the regulated charge voltage, typically 4.2V/4.3V/4.35V/4.4V and the charger current is below 10% of fast charge setting current, charging of the battery will discontinue and no more current will be delivered.

At this time,  $\overline{STDBY}$  pulled low by internal switches, indicating the completion of charging. In addition,  $\overline{STDBY}$  pin will be in a high-impedance state

### CHARGE STATUS INDICATION

The  $\overline{CHRG}$  pin and the  $\overline{STDBY}$  pin indicates the status of the battery charger..Four possible states are represented by charging, complete, fault, floating

Table 1 illustrates the four possible states of them when the battery charger is active.

Charge Status	$\overline{CHRG}$ LED	$\overline{STDBY}$ LED
<b>Charging</b>	ON	OFF
<b>Complete</b>	OFF	ON
<b>Fault</b> UVLO	OFF	OFF
<b>Floating</b> BAT Pin C=10uF and Battery unavailable	$\overline{STDBY}$ LED ON, $\overline{CHRG}$ LED TWINKLE(About 1~4s)	

### AUTOMATIC RECHARGE

After the battery charger terminates, it will remain off, drawing only microamperes of current from the battery. If the portable product remains in this state long enough, the battery will eventually self discharge. To ensure that the battery is always topped off, a charge cycle will automatically begin when the battery voltage falls below  $V_{RECHRG}$ (typically 4.08V).

### SHUT DOWN

When the Voltage of CE pin is disable, SL3027 SERIES will shut down. the shut down current will below 2.5uA.

**TYPICAL PERFORMANCE CHARACTERISTICS**

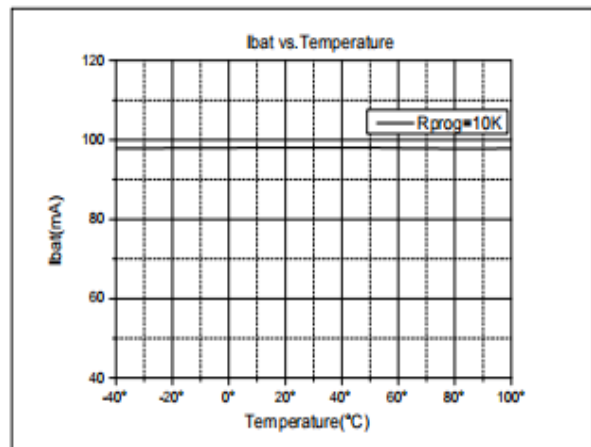
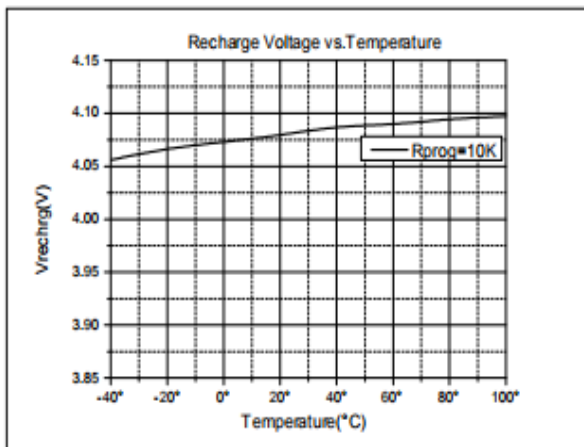
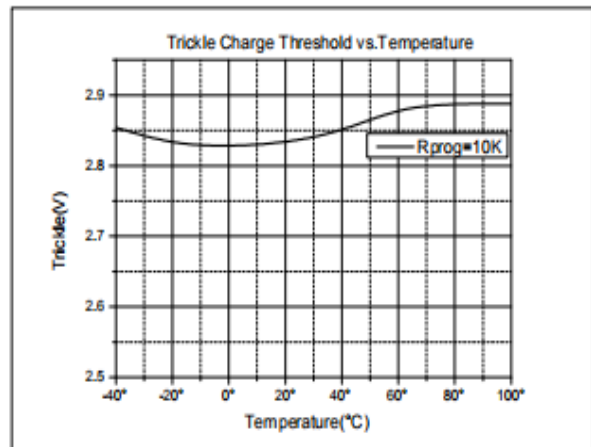
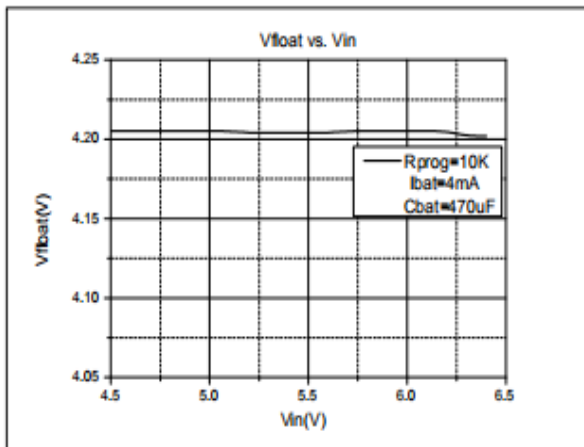
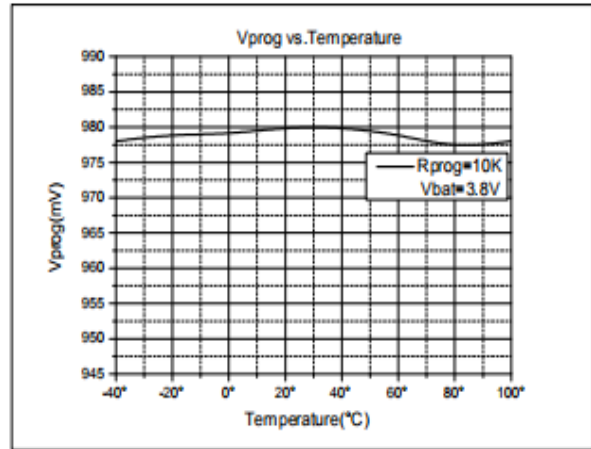
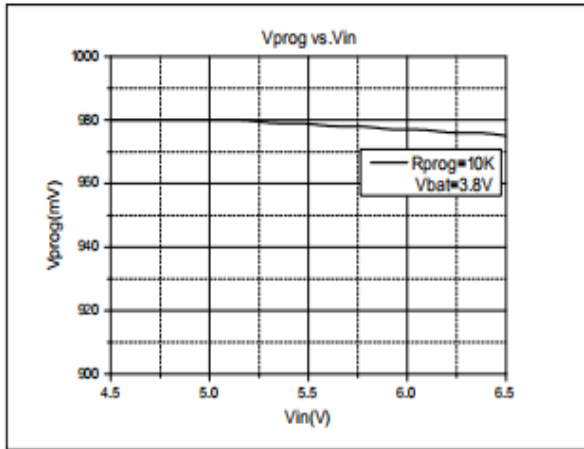



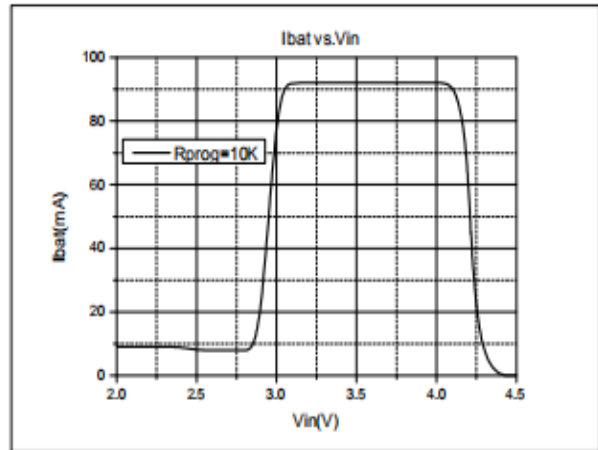
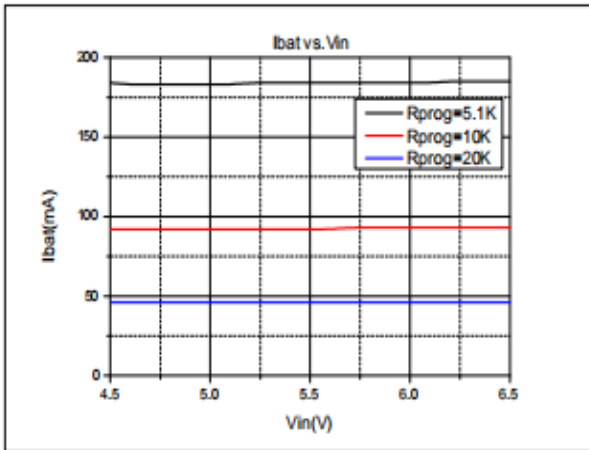

## PACKAGE OUTLINE

### DFN2X2-8 PACKAGE OUTLINE AND DIMENSIONS

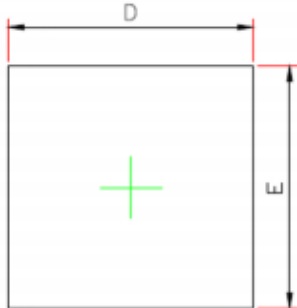

TOP VIEW

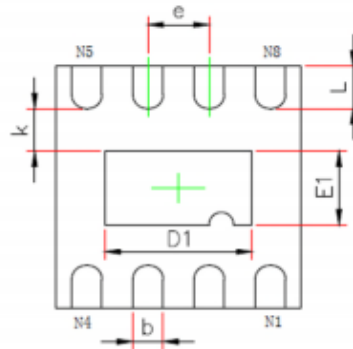

SIDE VIEW

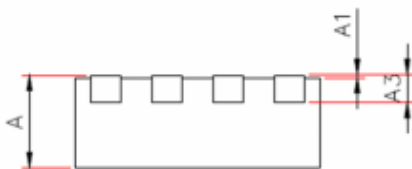

BOTTOM VIEW

Symbol	Dimensions In Millimeters		Dimensions In Inches	
	Min.	Max.	Min.	Max.
A	0.700/0.800	0.800/0.900	0.028/0.031	0.031/0.035
A1	0.000	0.050	0.000	0.002
A3	0.203REF.		0.008REF.	
D	1.950	2.050	0.077	0.081
E	1.950	2.050	0.077	0.081
D1	1.150	1.250	0.045	0.049
E1	0.550	0.650	0.022	0.026
k	0.350REF.		0.014REF.	
b	0.200	0.300	0.008	0.012
e	0.500BSC.		0.020BSC.	
L	0.300	0.400	0.012	0.016

## X-ON Electronics

Largest Supplier of Electrical and Electronic Components

*Click to view similar products for [Battery Management](#) category:*

*Click to view products by [SLKORMICRO](#) manufacturer:*

Other Similar products are found below :

[VN5R003HTR-E](#) [NCP1851BFCCT1G](#) [NCP1855FCCT1G](#) [FAN54063UCX](#) [LC05132C01NMTTGTG](#) [ISL78714ANZ](#) [CM1104-EH](#) [CM1104-DBB](#) [CM1104-MBB](#) [XC6801A421MR-G](#) [ISL95521BHRZ](#) [ISL95521BIRZ](#) [MP2639AGR-P](#) [S-82D1AAE-A8T2U7](#) [S-82D1AAA-A8T2U7](#) [S-8224ABA-I8T1U](#) [MC33772CTA1AE](#) [MC33772CTC0AE](#) [BQ28Z610DRZR-R1](#) [MCP73832-4ADI/MC](#) [MCP73832T-2DCIMC](#) [MCP73833T-AMIMF](#) [MCP73833T-AMI/UN](#) [MCP73838-NVI/MF](#) [MCP73213-A6BI/MF](#) [MCP73831-2ACI/MC](#) [MCP73831T-2ATIMC](#) [MCP73832-2ACI/MC](#) [MCP73832T-3ACIMC](#) [MCP73833T-FCI/MF](#) [MCP73853-IML](#) [BQ25895RTWR](#) [BQ29704DSER](#) [BQ78Z100DRZR](#) [ISL78610ANZ](#) [FAN5403UCX](#) [NCP367DPMUECTBG](#) [FAN54015BUCX](#) [MAX8934BETI+](#) [BQ24311DSGR](#) [BQ25100HYFPR](#) [BQ29707DSER](#) [MAX17048G+T10](#) [BQ24130RHRLR](#) [BQ25120AYFPR](#) [BQ29703DSER](#) [BQ771807DPJR](#) [BQ25120AYFPT](#) [MAX17055ETB+T](#) [MAX17710GB+T](#)