

Features

- Low gate charge.
- Trench FS Technology
- Saturation Voltage:
VCE(sat) = 1.8V @ IC = 40 A
- RoHS Complaint

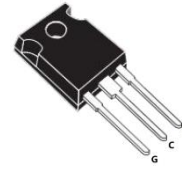

TO-247

Applications

- General purpose inverters
- UPS

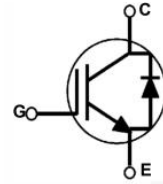

Absolute Maximum Ratings

Parameter	Symbol	Value	Unit	
Collector to Emitter Voltage	V _{CES}	1200	V	
Gate to Emitter Voltage	V _{GES}	±20		
Turn-off safe area	-	160	A	
Collector Current	I _C	T _C =25°C	80	A
		T _C =100°C	40	
Pulsed Collector Current TC=25°C	I _{CM}	160		
Diode forward current @ TC= 100°C	I _F	40		
Maximum Power Dissipation TC=25°C	P _D	718	W	
Operating Junction Temperature	T _J	-55 to 175	°C	
Storage Temperature Range	T _{stg}	-55 to 150		
Maximum Lead Temp. for soldering Purposes, 1/8" from case for 5 seconds	T _L	300		

*Collector current limited by maximum junction temperature

Notes: 1: Pulse width limited by maximum junction temperature

Thermal Characteristics

Parameter	Symbol	Typ	Unit
Thermal Resistance, Junction to Case	R _{θJC}	0.209	°C/W
Thermal Resistance, Junction to Ambient	R _{θJA}	34.09	

Electrical Characteristics $T_C = 25^\circ\text{C}$ unless otherwise noted

Parameter	Symbol	Test Conditions	Min	Type	Max	Unit
On/off Characteristics						
Collector to Emitter Breakdown Voltage	BV_{CES}	$V_{GE} = 0V, I_C = 250\mu$	1200	-	-	V
Breakdown Voltage Temperature Coefficient	$\Delta BV_{CES}/\Delta T_J$	$I_C=0.5mA$, referenced to 25°C	-	0.6	-	$V/^\circ\text{C}$
Zero Gate Voltage Collector Current	I_{CES}	$V_{CE}=1200V, V_{GE}=0V, T_C=25^\circ\text{C}$	-	-	0.2	mA
		$V_{CE}=1200V, V_{GE}=0V, T_C=175^\circ\text{C}$	-	-	2	
Gate-body leakage current, forward	I_{GESF}	$V_{CE}=0V, V_{GE} = 20V$	-	-	200	nA
Gate-body leakage current, reverse	I_{GESR}	$V_{CE}=0V, V_{GE} = -20V$	-	-	-200	nA
On-Characteristics						
Gate Threshold Voltage	V_{TH}	$V_{CE} = V_{GE}, I_C=250\mu A$	4.5	-	6.5	V
Collector-Emmitter saturation Voltage	V_{CESAT}	$V_{GE}=15V, I_C=40A, T_C=25^\circ\text{C}$	-	1.8	2.0	V
		$V_{GE}=15V, I_C=40A, T_C=175^\circ\text{C}$	-	2.4	-	V
Dynamic Characteristics						
Input Capacitance	C_{ies}	$V_{CE} = 25V, V_{GE} = 0V, f = 1MHz$	-	4604	-	pF
Output Capacitance	C_{oes}		-	200	-	
Reverse Transfer Capacitance	C_{res}		-	49	-	
Switching Characteristics						
Turn-On Delay Time	$t_d(on)$	$V_{CC} = 600V, I_C = 40A, R_G = 12\Omega, V_{GE} = 15V, \text{Parasitic ductance} = 75nH, T_C=25^\circ\text{C}$	-	56	-	nS
Rise Tim	t_r		-	98	-	
Turn-Off Delay Tim	$t_d(off)$		-	208	-	
Fall Time	t_f		-	176	-	
Turn-On energy	E_{on}		-	2.10	-	
Turn-off energy	E_{off}		-	2.28	-	
Total switching energy	E_{tot}		-	4.38	-	
Turn-On Delay Time	$t_d(on)$	$V_{CC} = 600V, I_C = 40A, R_G = 12\Omega, V_{GE} = 15V, \text{Parasitic ductance} =$	-	50	-	
Rise Tim	t_r		-	98	-	
Turn-Off Delay Tim	$t_d(off)$		-	252	-	

Fall Time	tf	75nH TC=175°C	-	322	-	
Turn-On energy	Eon		-	2.24	-	
Turn-off energy	Eoff		-	3.48	-	
Total switching energy	Etot		-	5.72	-	
Total Gate Charge	Qg	VCC = 960V, IC = 40A, VGE = 15V	-	165	-	nC
Gate to Emitter Charge	Qge		-	46	-	
Gate to Collector Charge	Qgc		-	69	-	

Electrical Characteristics of the Diode $T_C = 25^\circ\text{C}$ unless otherwise noted

Parameter	Symbol	Test Conditions	Min	Type	Max	Unit	
Diode Forward Voltage	V_{FM}	$I_F = 40\text{A}$	-	2.3	3.0	V	
Diode Reverse Recovery Time	t_{rr}	$I_F = 40\text{A},$ $di_F/dt = 200\text{A}/\mu\text{s}$	$T_C = 25^\circ\text{C}$	-	376	-	ns
			$T_C = 125^\circ\text{C}$	-	618	-	
Diode Peak Reverse Recovery Current	I_{rr}		$T_C = 25^\circ\text{C}$	-	6.5	-	A
			$T_C = 125^\circ\text{C}$	-	13.3	-	
Diode Reverse Recovery Charge	Q_{rr}		$T_C = 25^\circ\text{C}$	-	1311	-	nC
			$T_C = 125^\circ\text{C}$	-	4283	-	

Typical Performance Characteristics

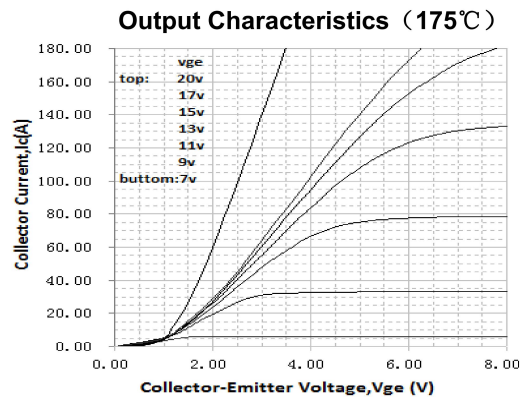
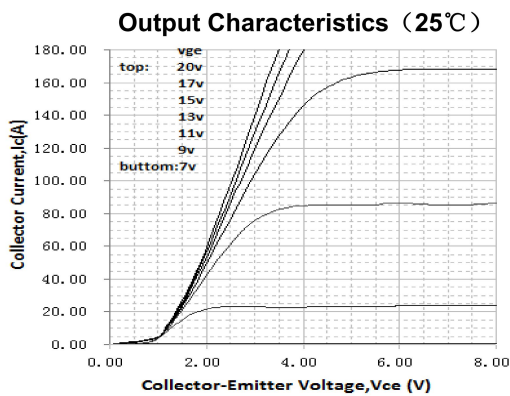

Transfer Characteristics

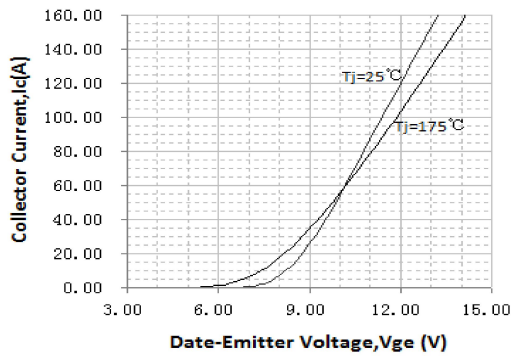

Vcesat vs. Tj

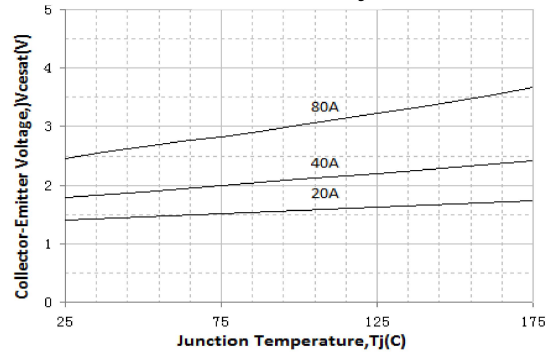

Vf vs. Tj

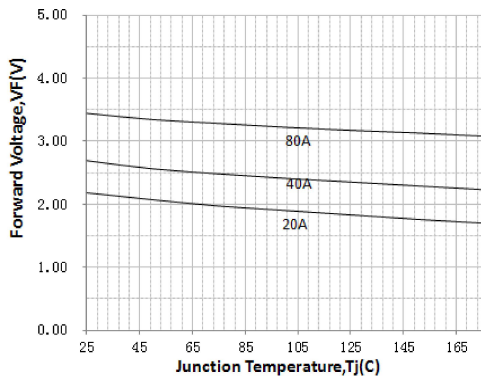

Vth vs. Tj

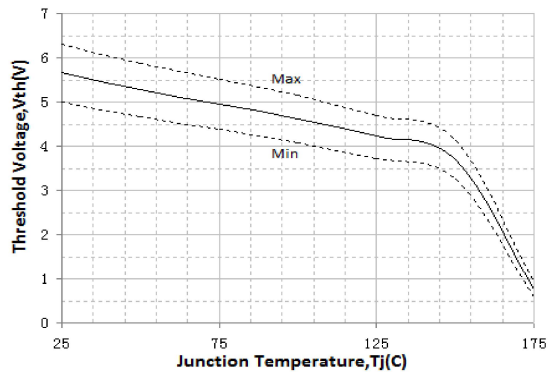

Diode Characteristic

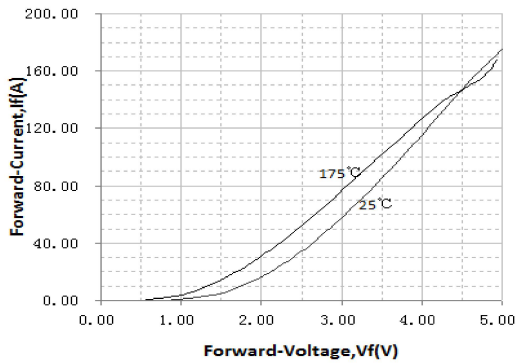

Collector current vs. case temperature

$V_{GE} \geq 15V, T_j \leq 175^\circ\text{C}$

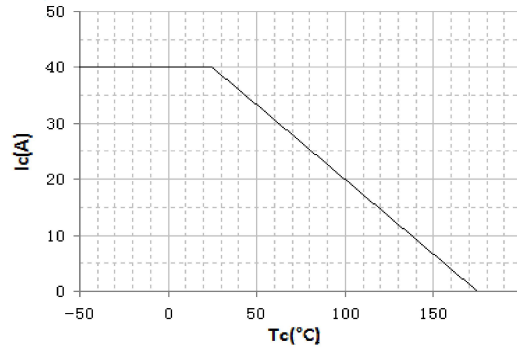

Gate Charge Characteristics

$V_{GE} = 15V, I_C = 40A$

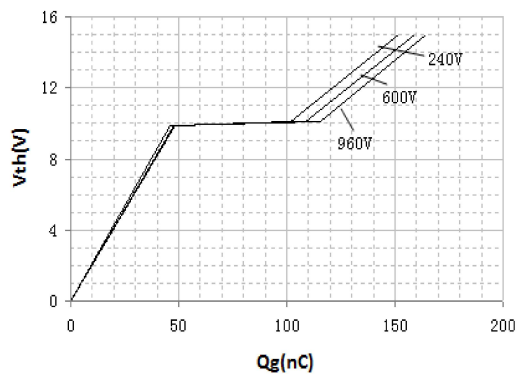

Capacitance Characteristic

$V_{ce} = 25V, V_{GE} = 0V, f = 1.0\text{MHz}$

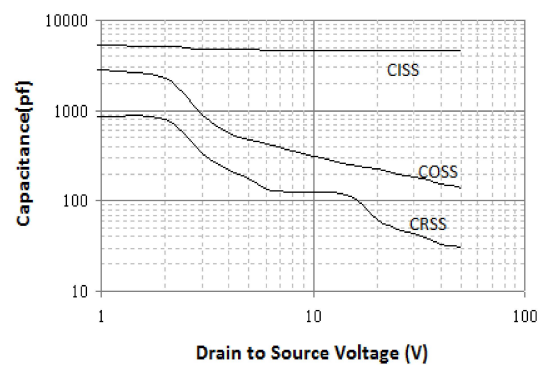

Switching Time vs. IC(25°C)

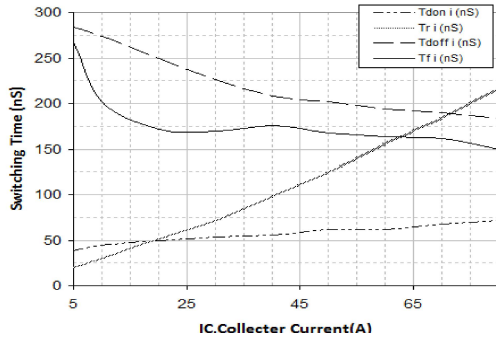

Switching Time vs. IC(175°C)

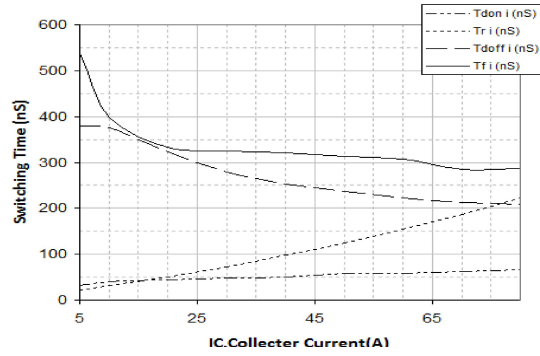

Switching Time vs. Rg(25°C)

VGE=15V, VCE=600V, IC=40A

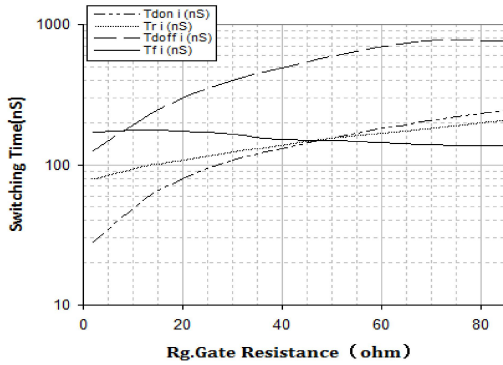

Switching Time vs. Rg(175°C)

VGE=15V, VCE=600V, IC=40A

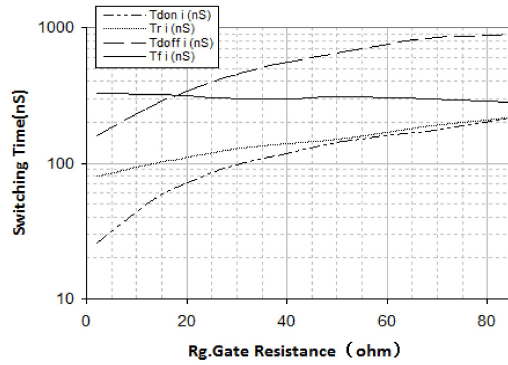

Switching Time vs. Tj

VGE=15V, VCE=600V, IC=40A, Rg=12Ω

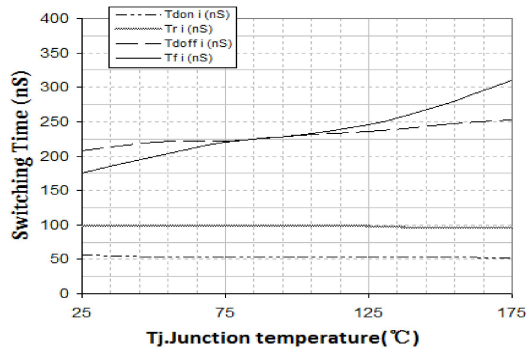

Switching Loss vs. Tj

VGE=15V, VCE=600V, IC=40A, Rg=12Ω

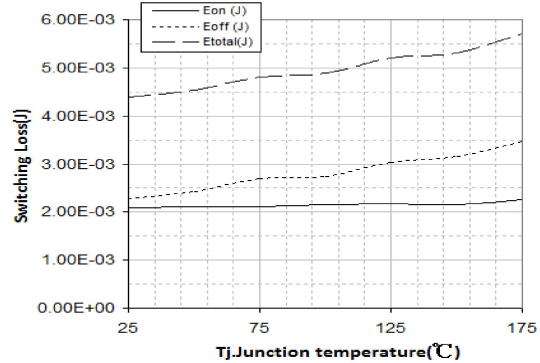

Switching Loss vs. IC(25°C)

VGE=15V, VCE=600V, Rg=12Ω

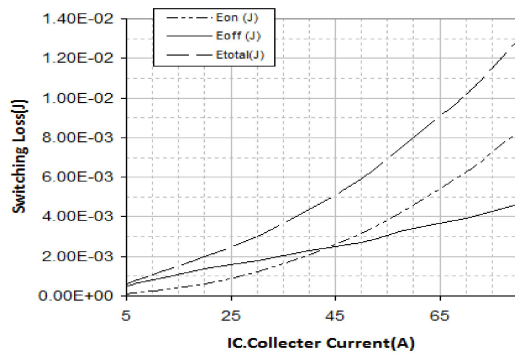

Switching Loss vs. IC(175°C)

VGE=15V, VCE=600V, Rg=12Ω

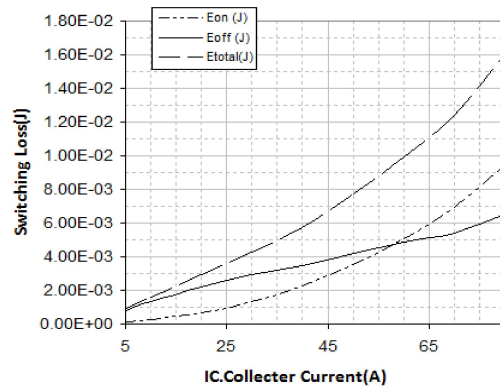

Switching Loss vs. Rg(25°C)

VGE=15V, VCE=600V, IC=40A

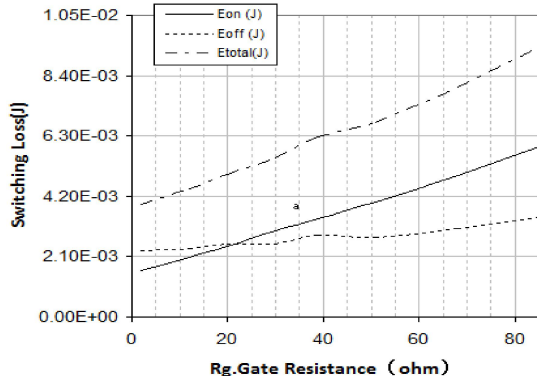

Switching Loss vs. Rg(175°C)

VGE=15V, VCE=600V, IC=40A

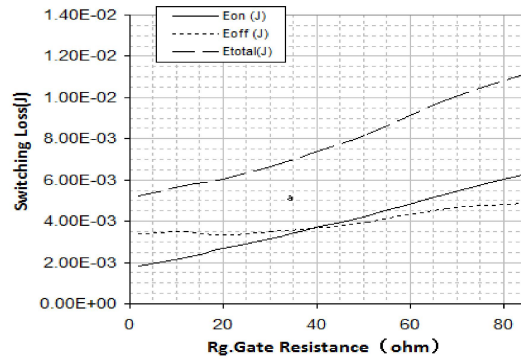

Switching Loss vs. VCE(25°C)

VGE=15V, IC=40A, Rg=12Ω

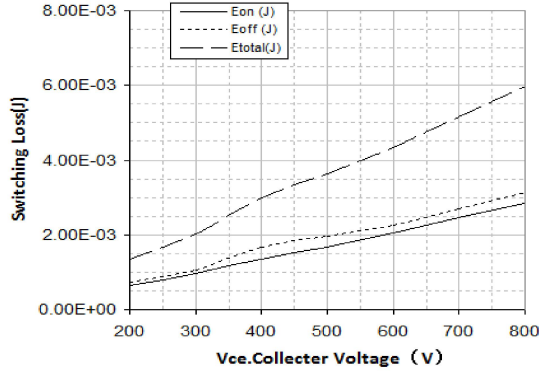

Switching Loss vs. VCE(175°C)

VGE=15V, IC=40A, Rg=12Ω

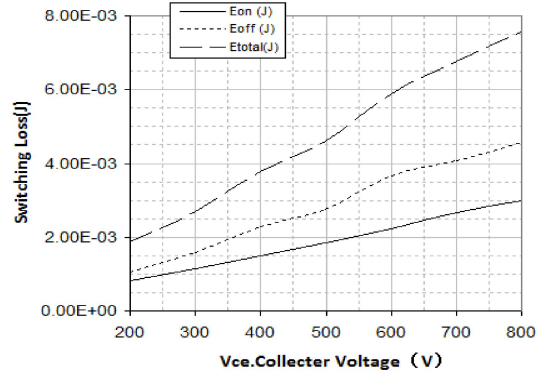

Forward Bias SOA

Tc=25°C, VGE=15V, Tj ≤ 175°C

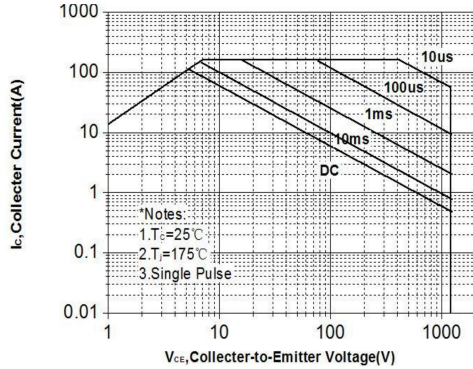

Normalized Maximum Transient Thermal Impedance for IGBT(RJA)

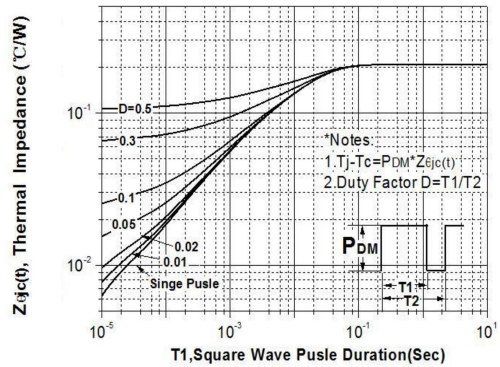

Package outline dimension

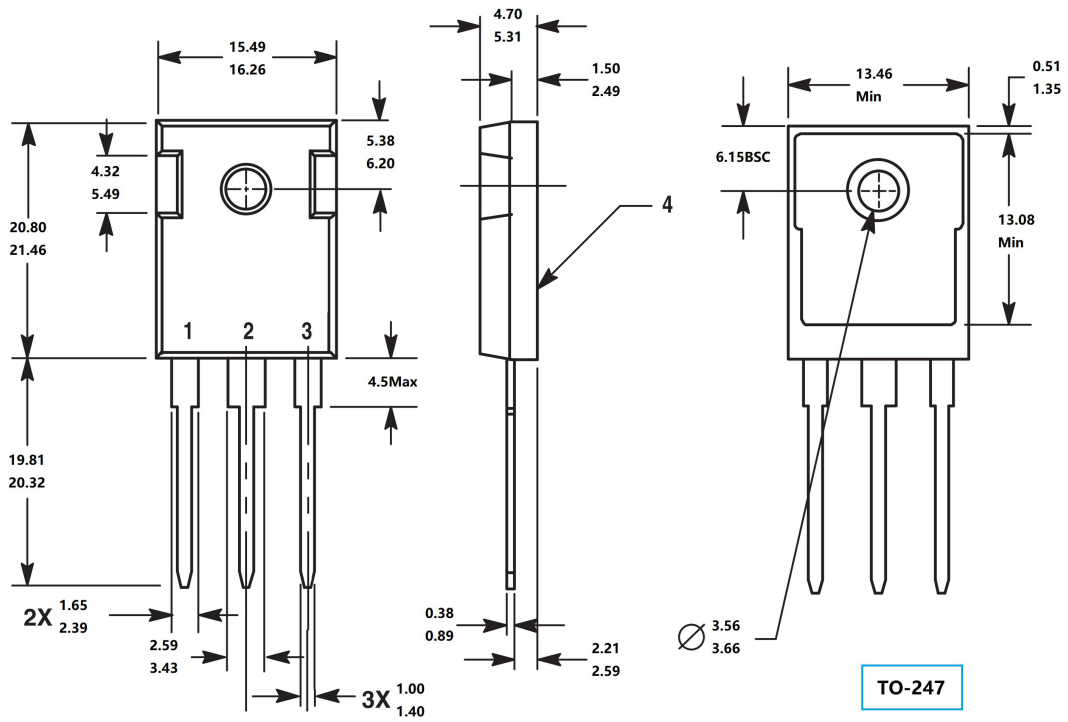

X-ON Electronics

Largest Supplier of Electrical and Electronic Components

Click to view similar products for [IGBT Transistors](#) category:

Click to view products by [SLKORMICRO](#) manufacturer:

Other Similar products are found below :

[IRG4PC30W](#) [APT20GT60BRDQ1G](#) [STGWA25H120DF2](#) [APT30GS60BRDQ2G](#) [TIG058E8-TL-H](#) [IDW40E65D2](#) [STGB40V60F](#)
[STGWA25H120F2](#) [NGTB75N65FL2WAG](#) [2MBI150VA-060-50](#) [NTE3320](#) [FGD3040G2-F085](#) [FGD3440G2-F085](#) [STGW80H65DFB-4](#)
[AFGY160T65SPD-B4](#) [IGW30N60TP](#) [IGW40N60TP](#) [IGW50N60TP](#) [IHW30N65R5](#) [IKFW40N60DH3E](#) [IKP15N65H5](#) [IKQ100N60T](#)
[IKQ120N60T](#) [IKW30N65WR5](#) [IKW75N60H3](#) [IKZ50N65NH5](#) [IKZ75N65NH5](#) [FGD3040G2-F085C](#) [FGH4L50T65SQD](#) [FGHL40T65MQDT](#)
[FGHL50T65MQD](#) [FGHL50T65MQDTL4](#) [FGHL75T65LQDT](#) [FGHL75T65MQD](#) [FGHL75T65MQDT](#) [FGHL75T65MQDTL4](#)
[FGY75T120SWD](#) [EL3120S1\(TA\)\(SAS\)-V](#) [IHW15N120E1](#) [IKQ75N120CS6](#) [IKW50N65WR5](#) [SL15T65FK](#) [KGF50N65KDF-U/H](#)
[IHF40N65R5S](#) [IKW08N120CS7XKSA1](#) [IKQ75N120CH3](#) [IHW30N160R5](#) [SGM100HF12A1TFD](#) [CRG50T60AK3SD](#) [CRG40T60AN3S](#)