

3-Terminal Voltage Regulator

Features

- Input voltage: up to 35V
- Output: 12V
- Output current up to 100 mA, internal thermal overload protection and short-circuit limiting.

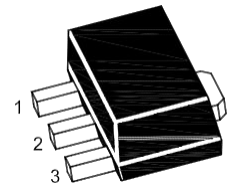

1. OUT 2. GND 3. IN

SOT-89

Maximum Ratings

Ratings at $T_A = 25^\circ\text{C}$ ambient temperature unless otherwise specified.

Parameter	Symbols	Value	Units
Input Voltage	V_I	35	V
Output Current	I_o	100	mA
Junction Temperature	T_J	150	$^\circ\text{C}$
Operating Temperature Range	T_{OPR}	-40~125	$^\circ\text{C}$
Power Dissipation	P_D	500	mW
Storage Temperature Range	T_{STG}	-55~150	$^\circ\text{C}$

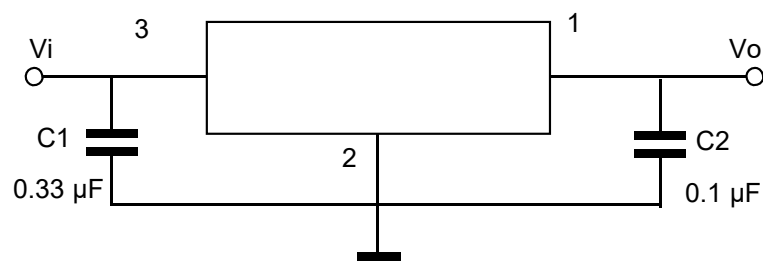

Electrical Characteristic

 Ratings at $T_A = 25^\circ\text{C}$ ambient temperature, $0^\circ\text{C} \leq T_J \leq 125^\circ\text{C}$ $V_I = 19\text{V}$, $I_O = 40\text{mA}$, $C_i = 0.33\mu\text{F}$, $C_o = 0.1\mu\text{F}$, unless otherwise specified.

Parameter	Symbols	Test Conditions	Min	Typ	Max	Unit
Output Voltage	V_O	$T_J = 25^\circ\text{C}$	11.5	12	12.5	V
		$I_O = 1\text{mA to } 40\text{mA}$ $V_I = 14.5\text{V to } 27\text{V}$	11.4	12	12.6	V
		$I_O = 1\text{mA to } 70\text{mA}$ $V_I = 19\text{V}$	11.4	12	12.6	V
Line Regulation	ΔV_O	$V_I = 14.5\text{V to } 27\text{V}$ $T_J = 25^\circ\text{C}$			250	mV
		$V_I = 16\text{V to } 27\text{V}$ $T_J = 25^\circ\text{C}$			200	mV
Load Regulation	ΔV_O	$I_O = 1\text{mA to } 100\text{mA}$, $T_J = 25^\circ\text{C}$			100	mV
		$I_O = 1\text{mA to } 40\text{mA}$, $T_J = 25^\circ\text{C}$			50	mV
Ripple Rejection	RR	$V_I = 15\text{V to } 25\text{V}$, $T_J = 25^\circ\text{C}$ $f = 120\text{Hz}$	37			dB
Output Noise Voltage	V_N	$f = 10\text{Hz} \sim 100\text{KHz}$ $T_J = 25^\circ\text{C}$		70		μV
Dropout Voltage	V_D	$T_J = 25^\circ\text{C}$		1.7		V
Quiescent Current	I_Q	$T_J = 25^\circ\text{C}$			6	mA
Quiescent Current Change	ΔI_Q	$V_I = 16\text{V to } 27\text{V}$			1.5	mA
		$I_O = 1\text{mA to } 40\text{mA}$			0.1	mA

Ratings and Characteristic Curves

Output Characteristics

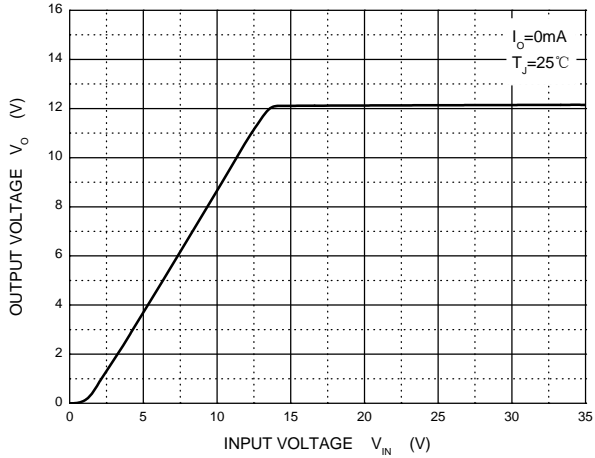

Current Cut-off Grid Voltage

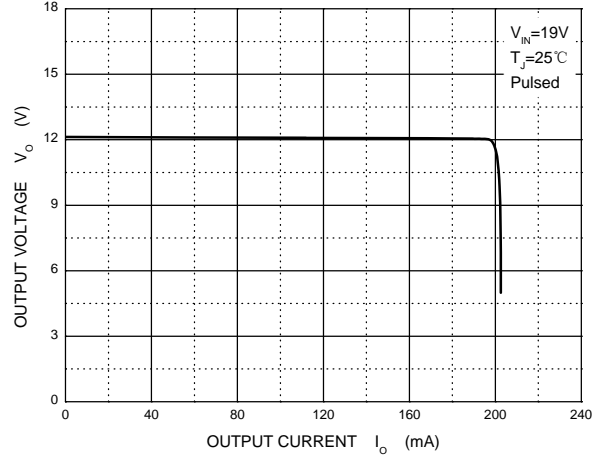

Quiescent Current

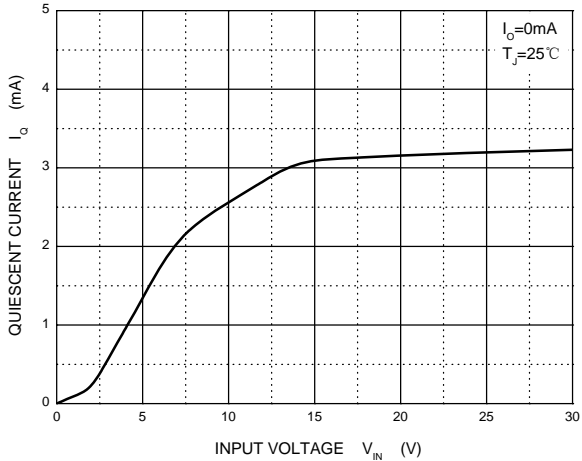

Power Derating Curve

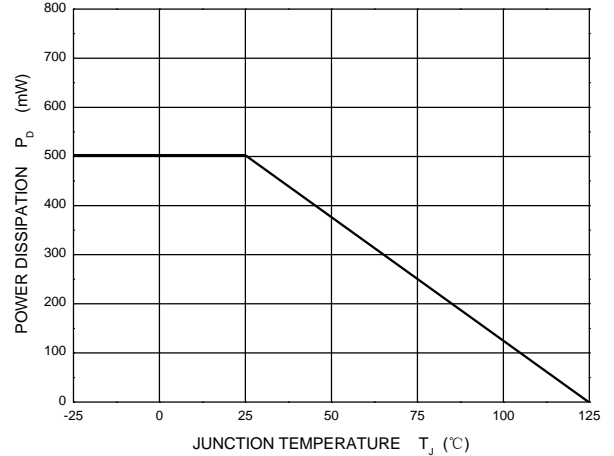

Output Voltage vs Junction Temperature

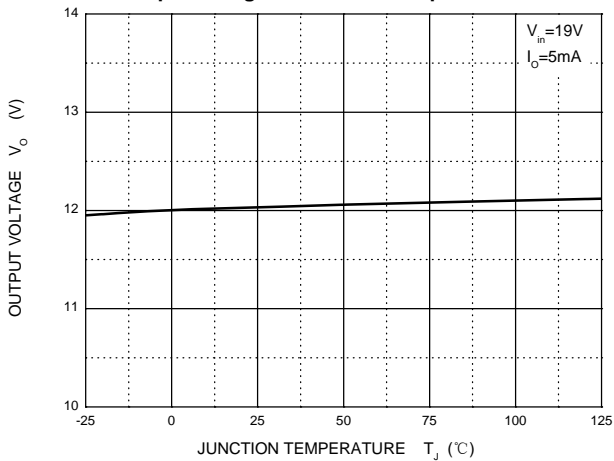

Package Outline

SOT-89

Dimensions in mm

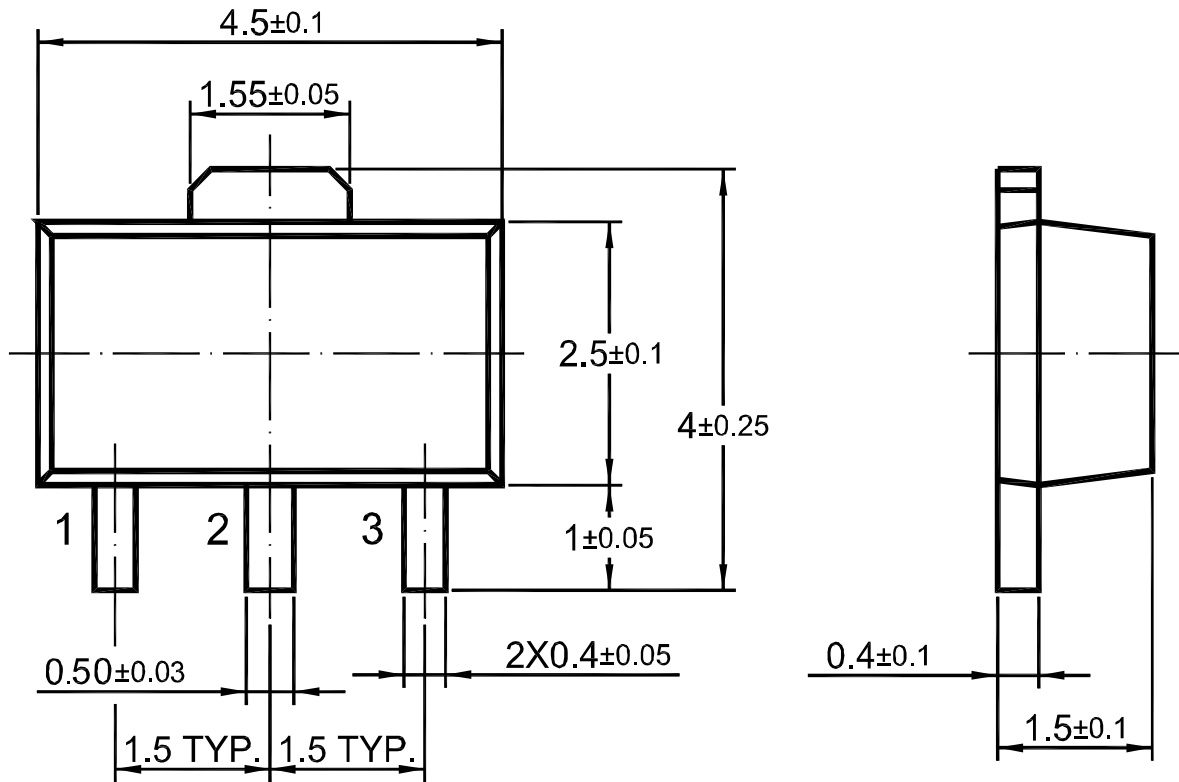

X-ON Electronics

Largest Supplier of Electrical and Electronic Components

Click to view similar products for [Linear Voltage Regulators](#) category:

Click to view products by [SLKORMICRO](#) manufacturer:

Other Similar products are found below :

[LV56831P-E](#) [LV5684PVD-XH](#) [MCDTSA6-2R](#) [L7815ACV-DG](#) [PQ3DZ53U](#) [LV56801P-E](#) [TLE42794G](#) [L78L05CZ/1SX](#) [L78LR05DL-MA-E](#) [636416C](#) [714954EB](#) [BA033LBSG2-TR](#) [LV5680P-E](#) [L78M15CV-DG](#) [TLS202B1MBV33HTSA1](#) [L79M05T-E](#) [TLS202A1MBVHTSA1](#) [L78LR05D-MA-E](#) [NCV317MBTG](#) [NTE7227](#) [LV5680NPVC-XH](#) [LT1054CN8](#) [MP2018GZD-5-Z](#) [MP2018GZD-33-Z](#) [MIC5281-3.3YMM](#) [RT9078-28GQZ](#) [MC78L06BP-AP](#) [TA48LS05F\(TE85L,F\)](#) [TA78L12F\(TE12L,F\)](#) [TC47BR5003ECT](#) [TCR2LN12,LF\(S](#) [TCR2LN28,LF\(S](#) [TCR2LN30,LF\(S](#) [TCR3DF295,LM\(CT](#) [TCR3DF40,LM\(CT](#) [BA178M20CP-E2](#) [L78M12ABDT](#) [LM7812SX/NOPB](#) [LR645N3-G-P003](#) [LR645N3-G-P013](#) [ZXTR2005P5-13](#) [SCD7812BTG](#) [TCR3DF335,LM\(CT](#) [ZXTR2012K-13](#) [TLE42994E V33](#) [ZXTR2008K-13](#) [ZXTR2005K-13](#) [LA5693D-E](#) [L88R05DL-E](#) [ADP3300ARTZ-2.7RL7](#)