

■ FEATURES

- **Wide supply voltage range 4.5V ~ 16V**
- **Input range 500mV beyond the rails**
- **Unity-gain stable**
- **Rail-to-rail output swing**
- **High slew rate 20V/ μ s**
- **GBWP 8MHz**
- **12 MHz -3dB Bandwidth**
- **Ultra-small Package MSOP-8**

■ APPLICATIONS

- **TFT-LCD Reference Driver**
- **Touch-Screen Display**
- **Wireless LANs**
- **Personal Communication Devices**
- **Direct Access Arrangement**
- **Personal Digital Assistant (PDA)**
- **Active Filter**
- **Sampling ADC Amplifier**
- **ADC/DAC Buffer**
- **Electronic Notebook**
- **Office Automation**
- **Portable Electronics**

■ GENERAL DESCRIPTION

The SL8052A is a rail-to-rail dual channels operational amplifier with wide supply range from 4.5V to 16V. It provides 0.5V beyond the supply rails of common mode input range and capability of rail-to-rail output swing as well. This enables the amplifier to offer maximum dynamic range at any supply voltage among many applications. A 8MHz gain bandwidth product allows SL8052A to perform more stable than other devices in Internet applications.

With features of 20V/ μ s high slew rate and 200ns of fast settling time, as well as 30mA (sink and source) of high output driving capability, the SL8052A is ideal for the requirements of flat panel Thin Film Transistor Liquid Crystal Displays (TFT-LCD) panel grayscale reference buffers application. Due to insensitive to power supply variation, SL8052A offers flexibility of use in multitude of applications such as battery power, portable devices and anywhere low power consumption is concerned. With standard operational amplifier pin assignment, the SL8052A is offered in a space saving 8-Pin MSOP package and specified over the -40°C to +85°C temperature range.

■ PIN ASSIGNMENT

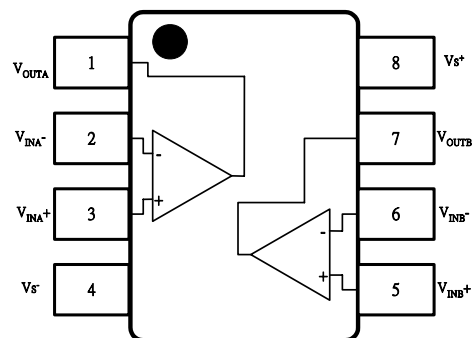

Package Type : MSOP-8

■ ABSOLUTE MAXIMUM RATINGS (TA = 25 °C)

Values beyond absolute maximum ratings may cause permanent damage to the device. These are stress ratings only; functional device operation is not implied. Exposure to AMR conditions for extended periods may affect device reliability.

Supply Voltage between VS+ and VS-	+16V	Storage Temperature	-65°C to +150°C
Input Voltage	VS- - 0.5V, VS +0.5V	Operating Temperature	-40°C to +85°C
Maximum Continuous Output Current	30mA	Lead Temperature	260°C
Maximum Die Temperature	+125°C		

Important Note:

All parameters having Min/Max specifications are guaranteed. Typical values are for information purposes only. Unless otherwise noted, all tests are at the specified temperature and are pulsed tests, therefore: TJ = TC = TA

■ ELECTRICAL CHARACTERISTICS

VS+ = +5V, VS- = -5V, RL = 10kΩ and CL = 10pF to 0V, TA = 25°C unless otherwise specified.

Parameter	Description	Condition	Min	Typ	Max	Units
Input Characteristics						
VOS	Input Offset Voltage	VCM = 0V		2	12	mV
TCVOS	Average Offset Voltage Drift	[1]		5		μV/°C
IB	Input Bias Current	VCM = 0V		2	50	nA
RIN	Input Impedance			1		GΩ
CIN	Input Capacitance			1.35		pF
CMIR	Common-Mode Input Range		-5.5		+5.5	V
CMRR	Common-Mode Rejection Ratio	for VIN from -5.5V to 5.5V	50	70		dB
AVOL	Open-Loop Gain	-4.5V ≤ VOUT ≤ 4.5V	75	95		dB
Output Characteristics						
VOL	Output Swing Low-	IL = -5mA		-4.92	-4.85	V
VOH	Output Swing High	IL = 5mA	4.85	4.92		V
ISC	Short Circuit Current			±120		mA
IOUT	Output Current			±30		mA
Power Supply Performance						
PSRR	Power Supply Rejection Ratio	VS is moved from ±3.75V to ±7.75V	60	80		dB
IS	Supply Current (Per Amplifier)	No Load		1.2	1.5	mA
Dynamic Performance						
SR	Slew Rate [2]	-4.0V ≤ VOUT ≤ 4.0V, 20% to 80%	13	20		V/μs
tS	Settling to +0.1% (AV = +1)	(AV = +1), VO = 2V Step		200		ns
BW	-3dB Bandwidth	RL = 10kΩ, CL = 10pF		12		MHz
GBWP	Gain-Bandwidth Product	RL = 10kΩ, CL = 10pF		8		MHz
PM	Phase Margin	RL = 10kΩ, CL = 10 pF		60		Degrees
CS	Channel Separation	f = 1 MHz		75		dB
1. Measured over operating temperature range 2. Slew rate is measured on rising and falling edges						

■ ORDERING INFORMATION

PART NO	TOP MARK	PACKAGE TYPE
SL8052A	SL8052A	MSOP8 GREEN PACKAGE

■ **TYPICAL PERFORMANCE CURVES**

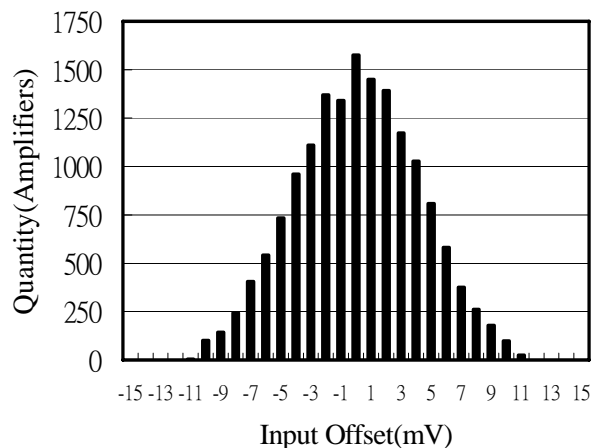

Figure (a) Input Offset Voltage Distribution

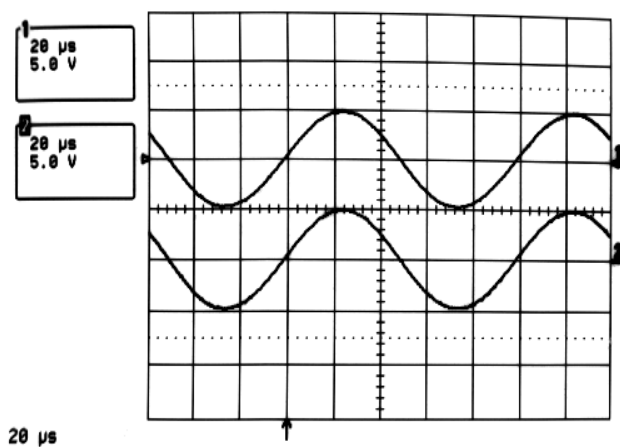

Figure (b) Rail to Rail Capability

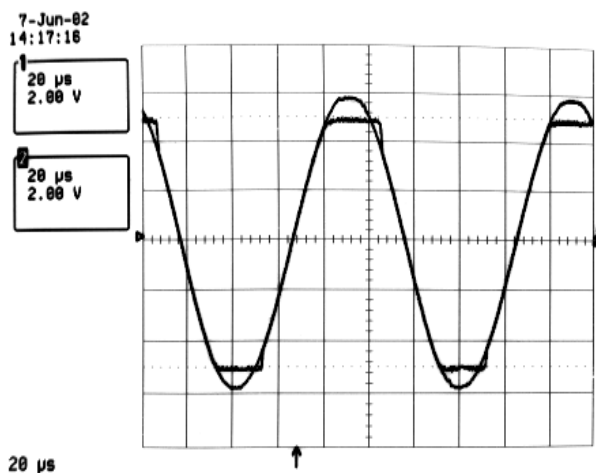

Figure (c) Input Beyond the Rails Signal

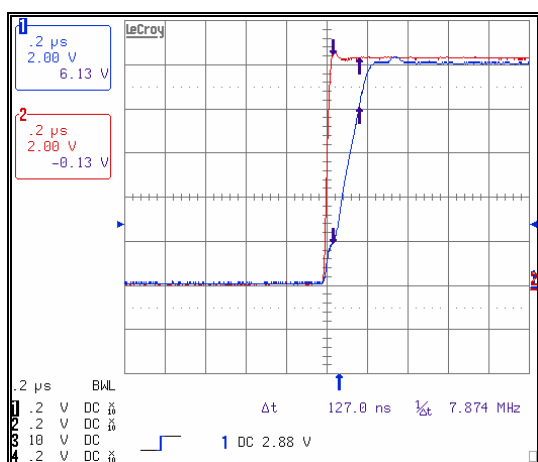

Figure (d) Large Signal Transient Response

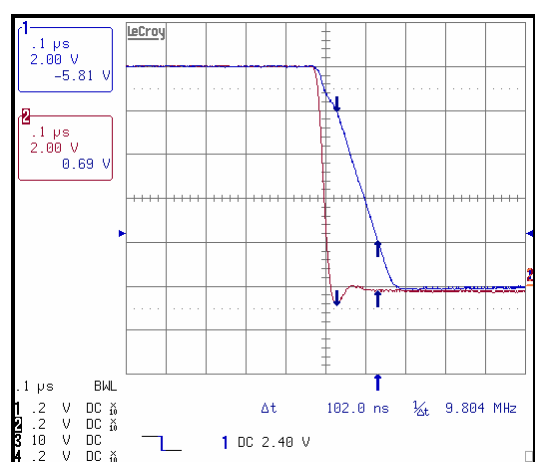

Figure (e) Large Signal Transient Response

■ **TYPICAL PERFORMANCE CURVES**

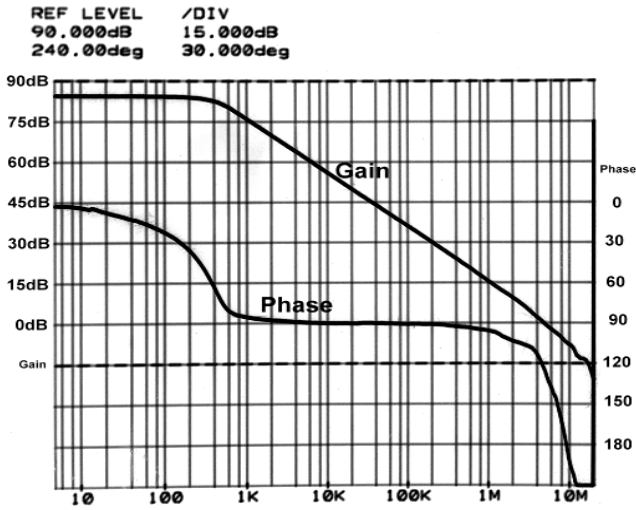

Figure (g) Open Loop Gain & Phase vs. Frequency

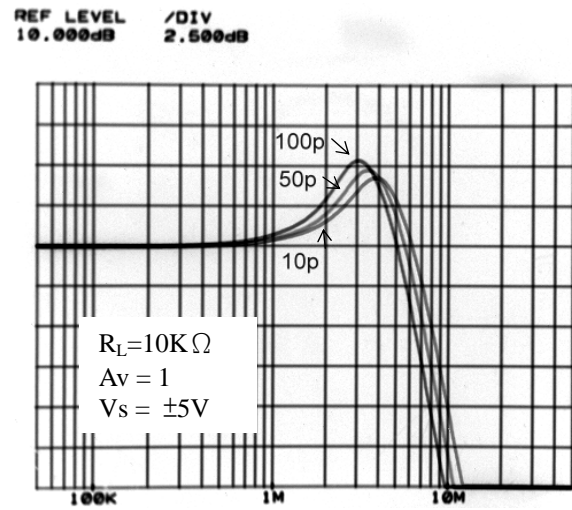

Figure (h) Frequency Response for Various C_L

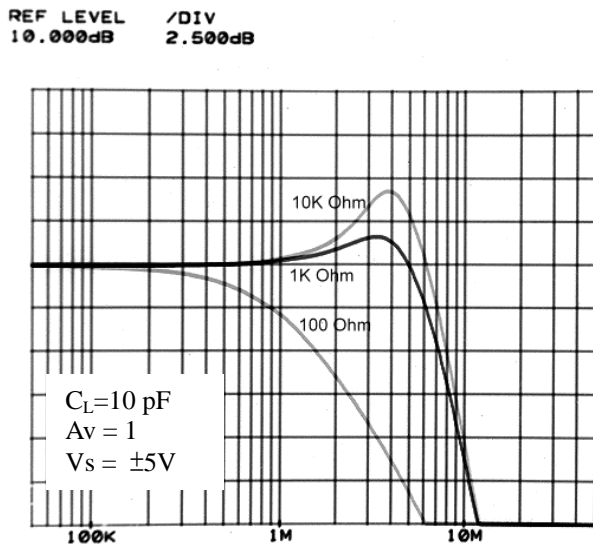

Figure (h) Frequency Response for Various R_L

■ APPLICATIONS INFORMATION

Product Description

The SL8052A rail-to-rail dual channels amplifier is built on an advanced high voltage CMOS process. It's beyond rails input capability and full swing of output range makes itself an ideal amplifier for use in a wide range of general-purpose applications. The features of 3.2V/ μ S high slew rate, fast settling time, 3.5MHz of GBWP as well as high output driving capability have proven the SL8052A a good voltage reference buffer in TFT-LCD for grayscale reference applications. High phase margin and extremely low power consumption (500 μ A per amplifier) make the SL8052A ideal for Connected in voltage follower mode for low power high drive applications

Supply Voltage, Input Range and Output Swing

The SL8052A can be operated with a single nominal wide supply voltage ranging from 4.5V to 18V with stable performance over operating temperatures of -40 °C to +85 °C.

With 500mV greater than rail-to-rail input common mode voltage range and 70dB of Common Mode Rejection Ratio, the SL8052A allows a wide range sensing among many applications without having any concerns over exceeding the range and no compromise in accuracy. The output swings of the SL8052A typically extend to within 80mV of positive and negative supply rails with load currents of 5mA. The output voltage swing can be even closer to the supply rails by merely decreasing the load current. Figure 1 shows the input and output waveforms for the device in the unity-gain configuration. The amplifier is operated under $\pm 5V$ supply with a 10k Ω load connected to GND. The input is a 10Vp-p sinusoid. An approximately 9.985 Vp-p of output voltage swing can be easily achieved.

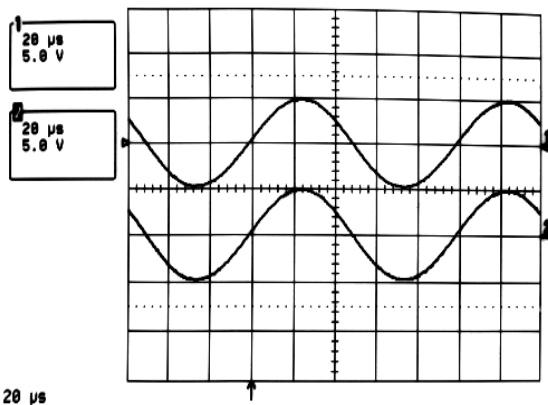

Figure 1. Operation with Rail-to-Rail Input and Output

Output Short Circuit Current Limit

A ± 120 mA short circuit current will be limited by the SL8052A if the output is directly shorted to the positive or the negative supply. For an indefinitely output short

circuit, the power dissipation could easily increase such that the device may be damaged. The internal metal interconnections are well designed to prevent the output continuous current from exceeding ± 30 mA such that the maximum reliability can be well maintained.

Output Phase Reversal

The SL8052A is designed to prevent its output from being phase reversal as long as the input voltage is limited from $V_{S-} - 0.5V$ to $V_{S+} + 0.5V$. Figure 2 shows a photo of the device output with its input voltage driven beyond the supply rails. Although the phase of the device's output will not be reversed, the input's over-voltage should be avoided. An improper input voltage exceeds supply range by more than 0.6V may result in an over stress damage.

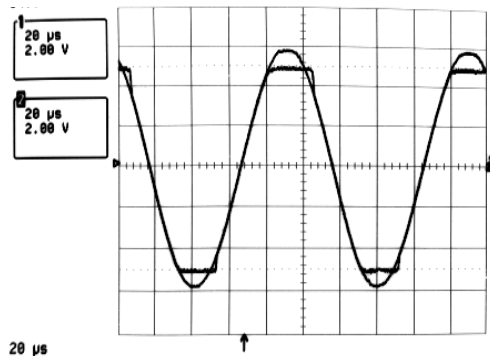

Figure 2. Operation with Beyond-the Rails Input

Power Dissipation

The SL8052A is designed for maximum output current capability. Even though momentary output shorted to ground causes little damage to device.

For the high drive amplifier SL8052A, it is possible to exceed the 'absolute-maximum junction temperature' under certain load current conditions. Therefore, it is important to calculate the maximum junction temperature for the application to determine if load conditions need to be modified for the amplifier to remain in the safe operating area. The maximum power dissipation allowed in a package is determined according to:

$$P_{Dmax} = \frac{T_{Jmax} - T_{Amax}}{\Theta_{JA}}$$

Where:

T_{Jmax} = Maximum Junction Temperature

T_{Amax} = Maximum Ambient Temperature

Θ_{JA} = Thermal Resistance of the Package

P_{Dmax} = Maximum Power Dissipation in the Package.

The maximum power dissipation actually produced by an IC is the total quiescent supply current times the total

power supply voltage, plus the power in the IC due to the loads, or:

$$P_{Dmax} = \sum_i [V_S * I_{Smax} + (V_{S+} - V_O) * I_L]$$

When sourcing, and

$$P_{Dmax} = \sum_i [V_S * I_{Smax} + (V_O - V_{S-}) * I_L]$$

When sinking.

Where:

$i = 1$ to 2

V_S = Total Supply Voltage

I_{Smax} = Maximum Supply Current Per Amplifier

V_O = Maximum Output Voltage of the Application

I_L = Load current

R_L = Load Resistance = $(V_{S+} - V_O) / I_L = (V_O - V_{S-}) / I_L$

A calculation for R_L to prevent device from overheat can be easily solved by setting the two P_{Dmax} equations equal to each other. Figure 3 and Figure 4 show the relationship between package power dissipation and ambient temperature under the JEDEC JESD 51-7 high effective thermal conductivity test board and SEMI G42-88 single layer test board respectively. From these charts, conditions of the device overheat then can be easily found. The maximum safe power dissipation can be found graphically, based on the package type and the ambient temperature. By using the previous equation, it is a simple matter to see if P_{Dmax} exceeds the device's power de-rating curves. To ensure proper operation, it is important to observe the recommended de-rating curves shown in Figure 3 and Figure 4.

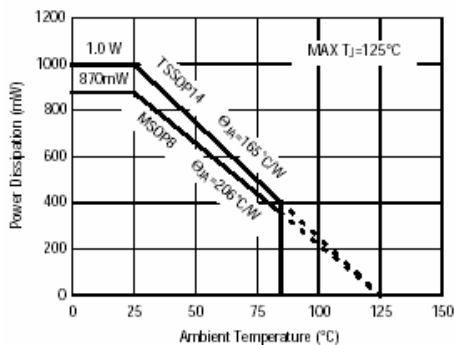

JEDEC JESD 51-7 High Effective Thermal Conductivity Test Board

Figure 3. Package Power Dissipation vs. Ambient Temperature

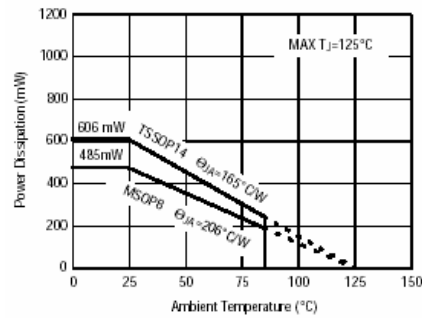

SEMI G42-88 Single Layer Test Board

Figure 4. Package Power Dissipation vs. Ambient Temperature

Driving Capacitive Loads

The SL8052A is designed to drive a wide range of capacitive loads. In addition, the output current handling capability of the device allows for good slewing characteristics even with large capacitive loads. The combination of these features make the SL8052A ideally for applications such as TFT LCD panel grayscale reference voltage buffers, ADC input amplifiers, etc.

As load capacitance increases, however, the -3dB bandwidth of the device will decrease and the peaking increase. The amplifiers drive 10pF loads in parallel with 10 kΩ with just 1.5dB of peaking, and 100pF with 6.4dB of peaking. If less peaking is desired in these applications, a small series resistor (usually between 5 Ω and 50 Ω) can be placed in series with the output. However, this will obviously reduce the gain slightly. Another method of reducing peaking is to add a "snubber" circuit at the output. A snubber is a shunt load consisting of a resistor in series with a capacitor. Values of 150Ω and 10nF are typical. The advantage of a snubber is that it improves the settling and overshooting performance while does not draw any DC load current or reduce the gain.

Power Supply Bypassing and Printed Circuit Board Layout

With high phase margin, the SL8052A performs stable gain at high frequency. Like any high-frequency device, good layout of the printed circuit board usually comes with optimum performance. Ground plane construction is highly recommended, lead lengths should be as short as possible and the power supply pins must be well bypassed to reduce the risk of oscillation. For normal single supply operation, where the V_{S-} pin is connected to ground, a 0.1 μF ceramic capacitor should be placed from V_{S+} pin to V_{S-} pin as a bypassing capacitor. A 4.7μF tantalum capacitor should then be connected in parallel, placed in the region of the amplifier. One 4.7μF capacitor may be used for multiple devices. This same capacitor combination should be placed at each supply pin to ground if split supplies are to be used.

■ **OUTLINE DIMENSIONS** (Dimensions shown in millimeters)
MSOP-8

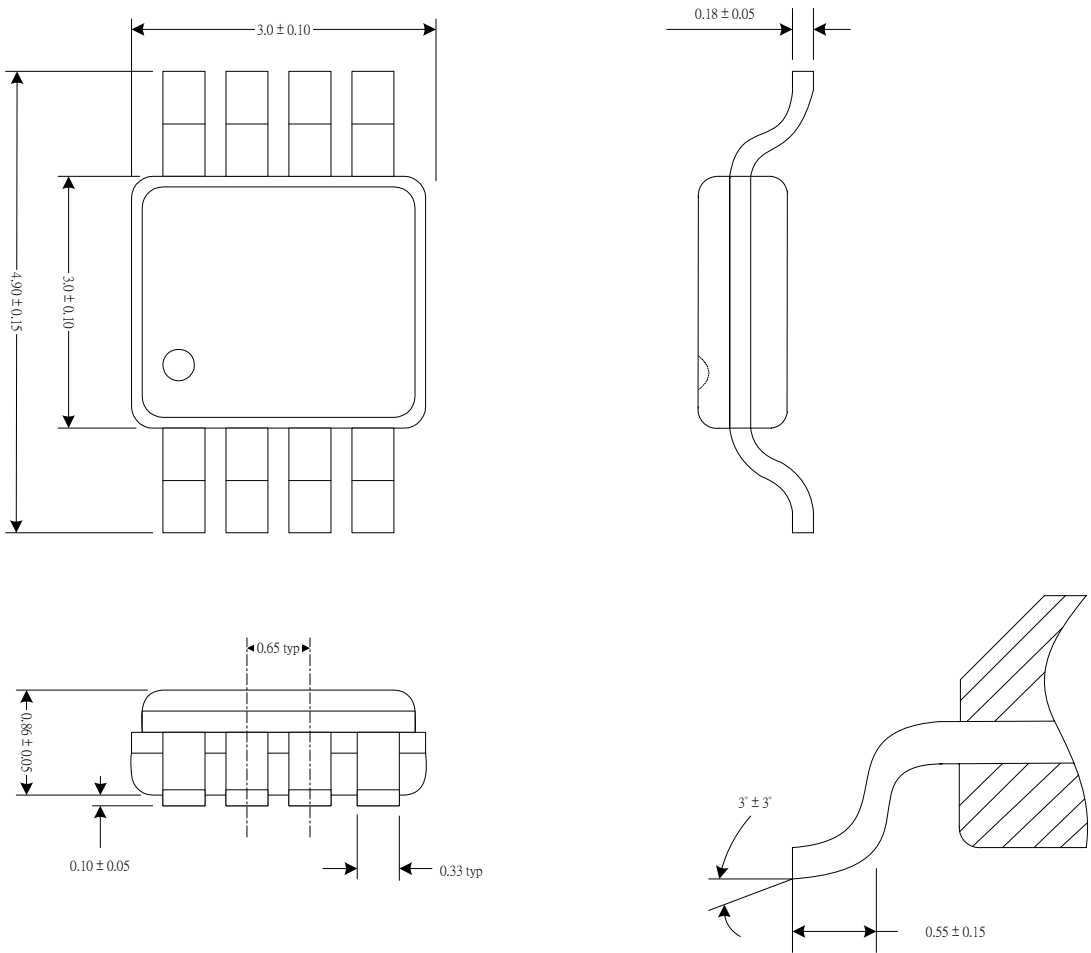

■ **PACKAGE MARKING INDICATION**

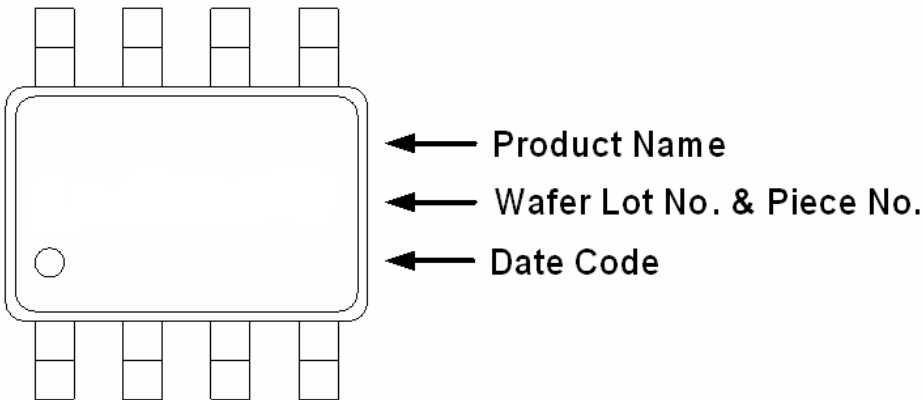

X-ON Electronics

Largest Supplier of Electrical and Electronic Components

Click to view similar products for [Operational Amplifiers - Op Amps](#) category:

Click to view products by [SLKORMICRO](#) manufacturer:

Other Similar products are found below :

[430227FB](#) [UPC451G2-A](#) [UPC824G2-A](#) [LT1678IS8](#) [042225DB](#) [058184EB](#) [UPC822G2-A](#) [UPC258G2-A](#) [NCS5651MNTXG](#)
[NCV33202DMR2G](#) [NJM324E](#) [NTE925](#) [5962-9080901MCA*](#) [AZV358MTR-G1](#) [AP4310AUMTR-AG1](#) [HA1630D02MMEL-E](#)
[HA1630S01LPEL-E](#) [AZV358MMTR-G1](#) [SCY33178DR2G](#) [NJU77806F3-TE1](#) [NCV5652MUTWG](#) [NCV20034DR2G](#) [NTE778S](#) [NTE871](#)
[NTE924](#) [NTE937](#) [MCP6V16UT-E/OT](#) [MCP6V17T-E/MS](#) [MCP6V19T-E/ST](#) [SCY6358ADR2G](#) [NCS20282FCTTAG](#) [LM4565FVT-GE2](#)
[EL5420CRZ-T7A](#) [TSV772IQ2T](#) [TSV792IYST](#) [NJM2100M-TE1](#) [COS2262MR](#) [COS2252MR](#) [COS5532SRB](#) [COS2272MR](#) [LMV358MR](#)
[COS6002MR](#) [LMV358SR](#) [LM358SR](#) [RC4580MM/TR](#) [HGV8544M/TR](#) [HGV8541M/TR](#) [HGV8634M/TR](#) [HGV8542M/TR](#)
[HGV8544MT/TR](#)