

## Precision, 11MHz, Low-Noise, RRIO, CMOS Amplifiers

### General Description

The SL860x family of single-, dual-, and quad- channel operational amplifiers represents a new generation of general-purpose, low-power op-amps. Featuring rail-to-rail input and output (RRIO) swings, low quiescent current (typical 750  $\mu$ A) combined with a wide bandwidth (11 MHz) and very low noise (8 nV/ $\sqrt$ Hz at 10 kHz) makes this family very attractive for a variety of battery-powered applications that require a good balance between cost and performance, such as audio outputs, motor phase current sensing, photodiode amplification, barcode scanners and white goods. The low input bias current supports these amplifiers to be used in applications with mega-ohm source impedances.

The robust design of the SL860x amplifiers provides ease-of-use to the circuit designer: unity-gain stability with capacitive loads of up to 300 pF, integrated RF/EMI rejection filter, no phase reversal in overdrive conditions, and high electro-static discharge (ESD) protection (5-kV HBM). The SL860x amplifiers are optimized for operation at voltages as low as +1.8 V ( $\pm$ 0.9 V) and up to +5.5 V ( $\pm$ 2.75 V) at the temperature range of 0  $^{\circ}$ C to 70  $^{\circ}$ C, and operation at voltages from +2.0 V ( $\pm$ 1.0 V) to +5.5 V ( $\pm$ 2.75 V) over the extended temperature range of -40  $^{\circ}$ C to +125  $^{\circ}$ C.

The SL8605/SL8607 (single) is available in both SOT23-5L and SC70-5L packages. The SL8606 (dual) is offered in SOIC-8L, MSOP-8L and TSSOP-8L packages. The quad-channel SL8608 is offered in QFN-16L, SOIC-14L and TSSOP-14L packages.

### Features and Benefits

- Low Input Offset Voltage:  $\pm$ 0.35 mV Maximum
- Wide Unity-Gain Bandwidth: 11 MHz
- High Slew Rate: 11 V/ $\mu$ s
- Fast Settling: 0.26  $\mu$ s to 0.1%
- Low Noise: 8 nV/ $\sqrt$ Hz at 10 kHz
- Rail-to-Rail Input and Output
- Internal RF/EMI Filter
- Single 1.8 V to 5.5 V Supply Voltage Range at 0  $^{\circ}$ C to 70  $^{\circ}$ C
- Low Supply Current: 750  $\mu$ A at 5V Supply Per Amplifier
- Extended Temperature Range: -40 $^{\circ}$ C to +125 $^{\circ}$ C

### Applications

- Battery-Powered Instruments:
  - Consumer, Industrial, Medical, Notebooks
- Audio Outputs
- Motor Phase Current Sense
- Photodiode Amplification
- Sensor Signal Conditioning:
  - Sensor Interfaces, Loop-Powered, Active Filters

### Pin Configurations (Top View)

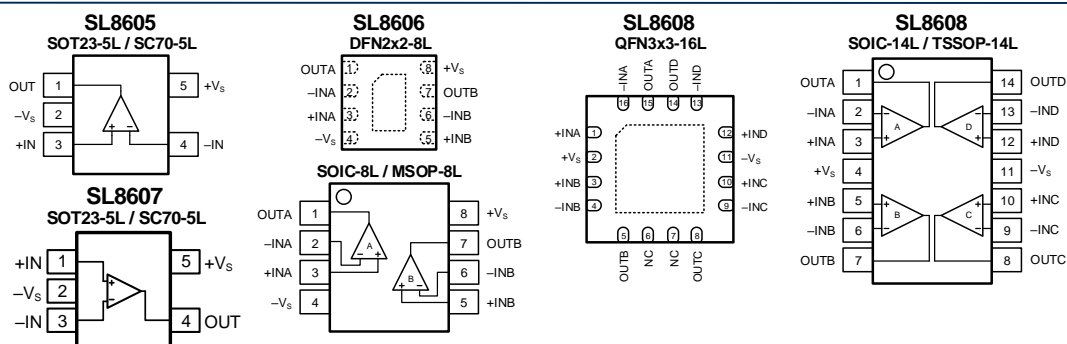

## Pin Description

Symbol	Description
-IN	Inverting input of the amplifier. The voltage range is from ( $V_{S-} - 0.1V$ ) to ( $V_{S+} + 0.1V$ ).
+IN	Non-inverting input of the amplifier. This pin has the same voltage range as -IN.
+V <sub>S</sub>	Positive power supply.
-V <sub>S</sub>	Negative power supply.
OUT	Amplifier output.

## Ordering Information

Type Number	Package Name	Package Quantity	Marking Code <sup>(1)</sup>
SL8605XT5	SOT23-5L	Tape and Reel, 3 000	AH1I
SL8605XC5	SC70-5L	Tape and Reel, 3 000	H5
SL8607XT5	SOT23-5L	Tape and Reel, 3 000	AH3I
SL8607XC5	SC70-5L	Tape and Reel, 3 000	H7
SL8606XF8	DFN2x2-8L	Tape and Reel, 3 000	AH2T
SL8606XS8	SOIC-8L	Tape and Reel, 4 000	SL8606XS8
SL8606XV8	MSOP-8L	Tape and Reel, 3 000	SL8606XV8
SL8606XT8	TSSOP-8L	Tape and Reel, 3 000	SL8606XT8
SL8608XS14	SOIC-14L	Tape and Reel, 2 500	SL8608XS14
SL8608XF16	QFN3x3-16L	Tape and Reel, 3 000	AH4T
SL8608XT14	TSSOP-14L	Tape and Reel, 3 000	SL8608XT14

*(1) There may be multiple device markings, a varied marking character of "x", or additional marking, which relates to the logo, the lot trace code information, or the environmental category on the device.*

## Limiting Value -In accordance with the Absolute Maximum Rating System (IEC 60134).

Parameter	Absolute Maximum Rating
Supply Voltage, $V_{S+}$ to $V_{S-}$	10.0 V
Signal Input Terminals: Voltage, Current	$V_{S-} - 0.5$ V to $V_{S+} + 0.5$ V, $\pm 10$ mA
Output Short-Circuit	Continuous
Storage Temperature Range, $T_{stg}$	$-65$ °C to $+150$ °C
Junction Temperature, $T_j$	150 °C
Lead Temperature Range (Soldering 10 sec)	260 °C

## ESD Rating

Parameter	Item	Value	Unit
Electrostatic Discharge Voltage	Human body model (HBM), per MIL-STD-883J / Method 3015.9 <sup>(1)</sup>	$\pm 5\ 000$	V
	Charged device model (CDM), per ESDA/JEDEC JS-002-2014 <sup>(2)</sup>	$\pm 2\ 000$	
	Machine model (MM), per JESD22-A115C	$\pm 250$	

*(1) JEDEC document JEP155 states that 500-V HBM allows safe manufacturing with a standard ESD control process. Manufacturing with less than 500-V HBM is possible if necessary precautions are taken.*

*(2) JEDEC document JEP157 states that 250-V CDM allows safe manufacturing with a standard ESD control process. Manufacturing with less than 250-V CDM is possible if necessary precautions are taken.*

## Electrical Characteristics

$V_S = 5.0V$ ,  $T_A = +25^\circ C$ ,  $V_{CM} = V_S/2$ ,  $V_O = V_S/2$ , and  $R_L = 10k\Omega$  connected to  $V_S/2$ , unless otherwise noted.

**Boldface limits apply over the specified temperature range,  $T_A = -40$  to  $+125^\circ C$ .**

Symbol	Parameter	Conditions	Min.	Typ.	Max.	Unit
<i>OFFSET VOLTAGE</i>						
$V_{OS}$	Input offset voltage	SL8605, SL8607, SL8607		$\pm 0.10$	$\pm 0.35$	mV
		SL8608		$\pm 0.12$	$\pm 0.50$	
$V_{OS\ TC}$	Offset voltage drift	$T_A = -40$ to $+125^\circ C$		$\pm 1$	<b>2.3</b>	$\mu V/^\circ C$
PSRR	Power supply rejection ratio	$V_S = 2.0$ to $5.5$ V, $V_{CM} < V_{S+} - 2$ V	95	110		dB
		$T_A = -40$ to $+125^\circ C$	<b>82</b>			
<i>INPUT BIAS CURRENT</i>						
$I_B$	Input bias current			1		pA
		$T_A = +85^\circ C$		150		
		$T_A = +125^\circ C$		500		
$I_{OS}$	Input offset current			1		pA
<i>NOISE</i>						
$V_n$	Input voltage noise	$f = 0.1$ to $10$ Hz		3		$\mu V_{P-P}$
$e_n$	Input voltage noise density	$f = 100$ Hz		19		nV/ $\sqrt{Hz}$
		$f = 10$ kHz		8		
$I_n$	Input current noise density	$f = 1$ kHz		3		fA/ $\sqrt{Hz}$
<i>INPUT VOLTAGE</i>						
$V_{CM}$	Common-mode voltage range		$V_{S-} - 0.1$		$V_{S+} + 0.1$	V
CMRR	Common-mode rejection ratio	$V_S = 5.5$ V, $V_{CM} = -0.1$ to $5.6$ V	80	96		dB
		$V_{CM} = 0$ to $5.3$ V, $T_A = -40$ to $+125^\circ C$	<b>75</b>			
		$V_S = 2.0$ V, $V_{CM} = -0.1$ to $2.1$ V	76	90		
		$V_{CM} = 0$ to $1.8$ V, $T_A = -40$ to $+125^\circ C$	<b>70</b>			
<i>INPUT IMPEDANCE</i>						
$C_{IN}$	Input capacitance	Differential		2.0		pF
		Common mode		3.5		
<i>OPEN-LOOP GAIN</i>						
$A_{VOL}$	Open-loop voltage gain	$R_L = 10$ k $\Omega$ , $V_O = 0.05$ to $3.5$ V	97	105		dB
		$T_A = -40$ to $+125^\circ C$	<b>87</b>			
		$R_L = 600$ $\Omega$ , $V_O = 0.15$ to $3.5$ V	85	90		
		$T_A = -40$ to $+125^\circ C$	<b>75</b>			
<i>FREQUENCY RESPONSE</i>						
GBW	Gain bandwidth product			11		MHz
SR	Slew rate	$G = +1$ , $C_L = 100$ pF, $V_O = 1.5$ to $3.5$ V		11		V/ $\mu s$
THD+N	Total harmonic distortion + noise	$G = +1$ , $f = 1$ kHz, $V_O = 0.5$ V <sub>RMS</sub>		0.0005		%
$t_S$	Settling time	To 0.1%, $G = +1$ , 1V step		0.26		$\mu s$
		To 0.01%, $G = +1$ , 1V step		0.34		
$t_{OR}$	Overload recovery time	$V_{IN} * Gain > V_S$		0.3		$\mu s$

## Electrical Characteristics (continued)

$V_S = 5.0V$ ,  $T_A = +25^\circ C$ ,  $V_{CM} = V_S/2$ ,  $V_O = V_S/2$ , and  $R_L = 10k\Omega$  connected to  $V_S/2$ , unless otherwise noted.

**Boldface limits apply over the specified temperature range,  $T_A = -40$  to  $+125^\circ C$ .**

Symbol	Parameter	Conditions	Min.	Typ.	Max.	Unit
<i>OUTPUT</i>						
$V_{OH}$	High output voltage swing	$R_L = 10\text{ k}\Omega$	$V_{S+}-12$	$V_{S+}-8$		mV
		$R_L = 600\ \Omega$	$V_{S+}-180$	$V_{S+}-125$		
$V_{OL}$	Low output voltage swing	$R_L = 10\text{ k}\Omega$		$V_{S-}+6$	$V_{S-}+9$	mV
		$R_L = 600\ \Omega$		$V_{S-}+90$	$V_{S-}+130$	
$I_{SC}$	Short-circuit current			$\pm 75$		mA
<i>POWER SUPPLY</i>						
$V_S$	Operating supply voltage	$T_A = 0$ to $+70^\circ C$	<b>1.8</b>		<b>5.5</b>	V
		$T_A = -40$ to $+125^\circ C$	<b>2.0</b>		<b>5.5</b>	
$I_Q$	Quiescent current (per amplifier)	$V_S = 2.0\text{ V}$		625	760	$\mu A$
		$V_S = 5.0\text{ V}$		750	930	
<i>THERMAL CHARACTERISTICS</i>						
$T_A$	Operating temperature range		-40		+125	$^\circ C$
$\theta_{JA}$	Package Thermal Resistance	SC70-5L		333		$^\circ C/W$
		SOT23-5L		190		
		MSOP-8L		216		
		TSSOP-8L		160		
		SOIC-8L		125		
		QFN3x3-16L		65		
		TSSOP-14L		112		
		SOIC-14L		115		

## Typical Performance Characteristics

At  $T_A = +25^\circ\text{C}$ ,  $V_{CM} = V_S/2$ , and  $R_L = 10\text{k}\Omega$  connected to  $V_S/2$ , unless otherwise noted.

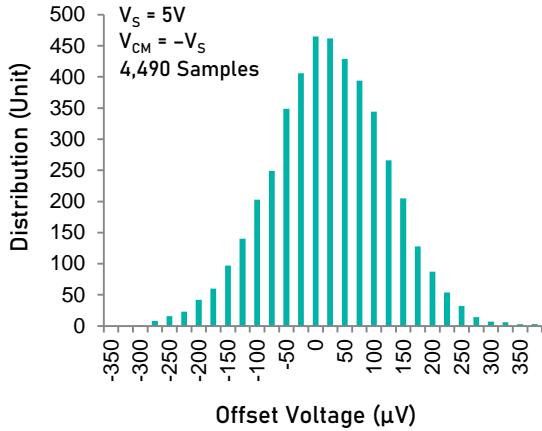

Offset Voltage Production Distribution

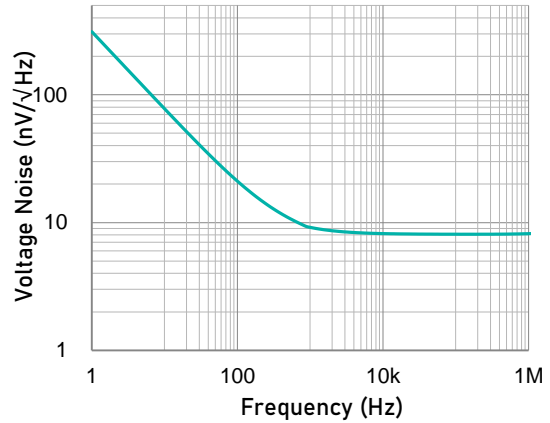

Input Voltage Noise Spectral Density as a function of Frequency.

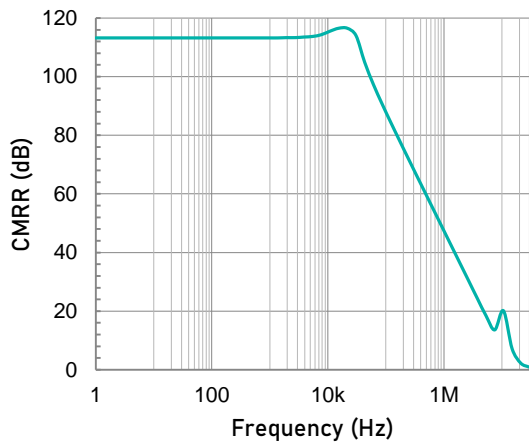

Common-mode Rejection Ratio as a function of Frequency.

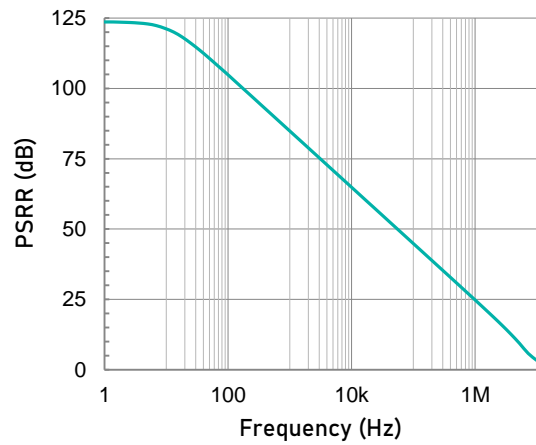

Power Supply Rejection Ratio as a function of Frequency.

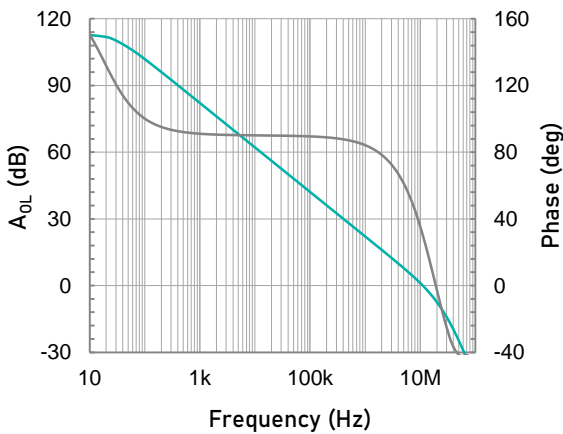

Open-loop Gain and Phase as a function of Frequency.

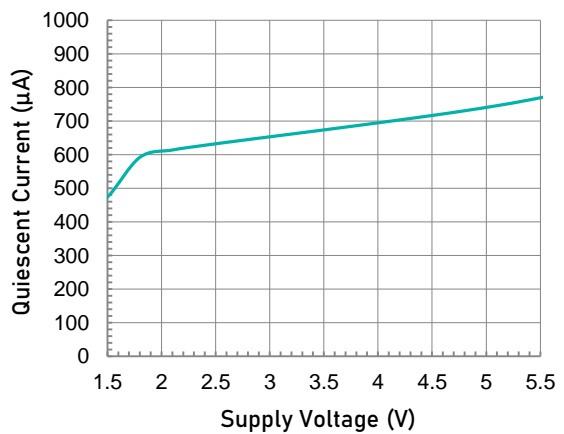

Quiescent Current as a function of Supply Voltage.

## Typical Performance Characteristics (continued)

At  $T_A = +25^\circ\text{C}$ ,  $V_{CM} = V_S/2$ , and  $R_L = 10\text{k}\Omega$  connected to  $V_S/2$ , unless otherwise noted.

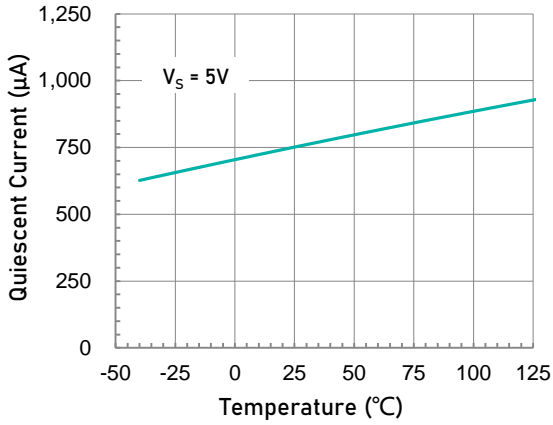

Quiescent Current as a function of Temperature.

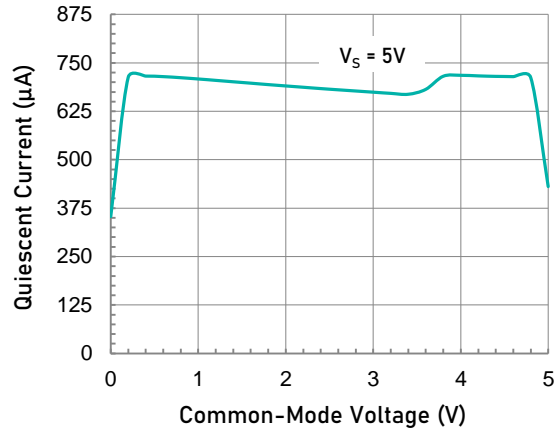

Quiescent Current as a function of Input Common-mode Voltage.

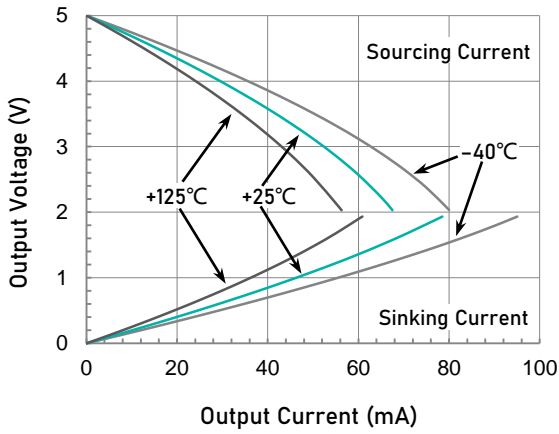

Output Voltage Swing as a function of Output Current.

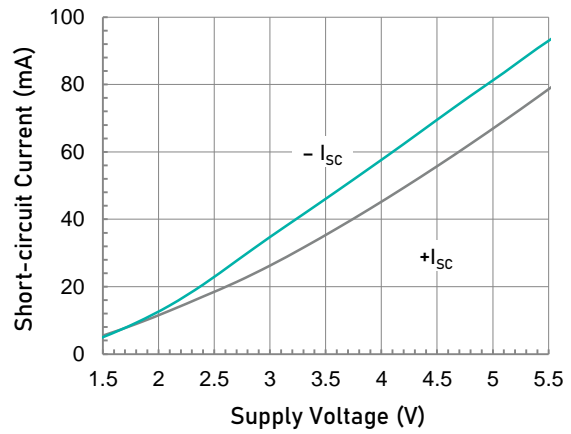

Short-circuit Current as a function of Supply Voltage.

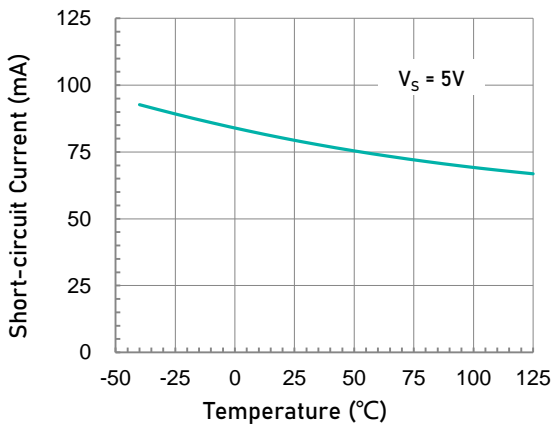

Short-circuit Current as a function of Temperature.

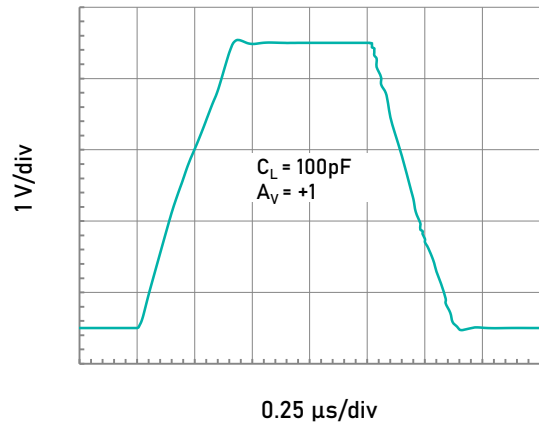

Large Signal Step Response.

## Typical Performance Characteristics (continued)

At  $T_A = +25^\circ\text{C}$ ,  $V_{CM} = V_S/2$ , and  $R_L = 10\text{k}\Omega$  connected to  $V_S/2$ , unless otherwise noted.

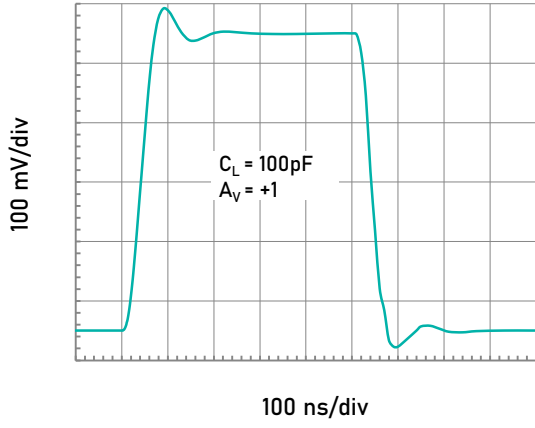

Small Signal Step Response (500 mV).

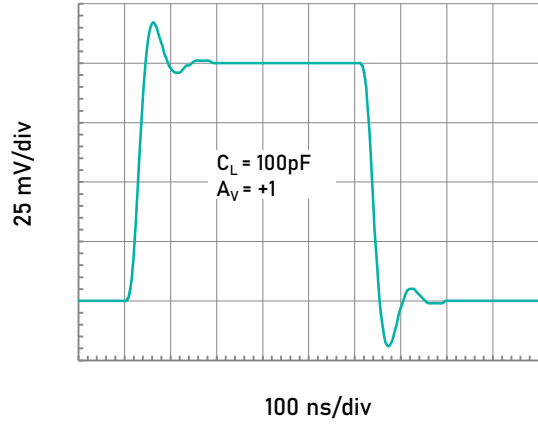

Small Signal Step Response (500 mV).



## Application Notes

The SL860x is a family of low-power, rail-to-rail input and output operational amplifiers specifically designed for portable applications. These devices operate from 1.8 V to 5.5 V at the temperature range of 0 °C to 70 °C, are unity-gain stable, and suitable for a wide range of general-purpose applications. The class AB output stage is capable of driving  $\leq 10\text{-k}\Omega$  loads connected to any point between  $V_{S+}$  and ground. The input common-mode voltage range includes both rails, and allows the SL860x family to be used in virtually any single-supply application. Rail-to-rail input and output swing significantly increases dynamic range, especially in low-supply applications, and makes them ideal for driving sampling analog-to-digital converters (ADCs).

The SL860x features 11-MHz bandwidth and 11  $-V/\mu\text{s}$  slew rate with only 750- $\mu\text{A}$  supply current per amplifier, providing good ac performance at very low power consumption. DC applications are also well served with a low input noise voltage of 8-nV/ $\sqrt{\text{Hz}}$  at 1-kHz, low input bias current, and an input offset voltage of 0.35-mV maximum. The typical offset voltage drift is 1- $\mu\text{V}/^\circ\text{C}$ , over the full temperature range the input offset voltage changes only 100- $\mu\text{V}$  (0.35-mV to 0.45-mV).

### OPERATING VOLTAGE

The SL860x family is optimized for operation at voltages as low as +1.8 V ( $\pm 0.9$  V) and up to +5.5 V ( $\pm 2.75$  V) at the temperature range of 0 °C to 70 °C, and fully specified and ensured for operation from 2.0 V to 5.5 V ( $\pm 1.0$  V to  $\pm 2.75$  V). In addition, many specifications apply from -40 °C to +125 °C. Parameters that vary significantly with operating voltages or temperature are illustrated in the Typical Characteristics graphs.

NOTE: Supply voltages ( $V_{S+}$  to  $V_{S-}$ ) higher than +10 V can permanently damage the device.

### RAIL-TO-RAIL INPUT

The input common-mode voltage range of the SL860x series extends 100-mV beyond the negative and positive supply rails. This performance is achieved with a complementary input stage: an N-channel input differential pair in parallel with a P-channel differential pair. The N-channel pair is active for input voltages close to the positive rail, typically  $V_{S+}-1.4$  V to the positive supply, whereas the P-channel pair is active for inputs from 100-mV below the negative supply to approximately  $V_{S+}-1.4$  V. There is a small transition region, typically  $V_{S+}-1.2$  V to  $V_{S+}-1$  V, in which both pairs are on. This 200-mV transition region can vary up to 200-mV with process variation. Thus, the transition region (both stages on) can range from  $V_{S+}-1.4$  V to  $V_{S+}-1.2$  V on the low end, up to  $V_{S+}-1$  V to  $V_{S+}-0.8$  V on the high end. Within this transition region, PSRR, CMRR, offset voltage, offset drift, and

THD can be degraded compared to device operation outside this region.

The typical input bias current of the SL860x during normal operation is approximately 1-pA. In overdriven conditions, the bias current can increase significantly. The most common cause of an overdriven condition occurs when the operational amplifier is outside of the linear range of operation. When the output of the operational amplifier is driven to one of the supply rails, the feedback loop requirements cannot be satisfied and a differential input voltage develops across the input pins. This differential input voltage results in activation of parasitic diodes inside the front-end input chopping switches that combine with electromagnetic interference (EMI) filter resistors to create the equivalent circuit. Notice that the input bias current remains within specification in the linear region.

### INPUT EMI FILTER AND CLAMP CIRCUIT

Figure 1 shows the input EMI filter and clamp circuit. The SL860x op-amps have internal ESD protection diodes (D1, D2, D3, and D4) that are connected between the inputs and each supply rail. These diodes protect the input transistors in the event of electrostatic discharge and are reverse biased during normal operation. This protection scheme allows voltages as high as approximately 500-mV beyond the rails to be applied at the input of either terminal without causing permanent damage. These ESD protection current-steering diodes also provide in-circuit, input overdrive protection, as long as the current is limited to 20-mA as stated in the Absolute Maximum Ratings.

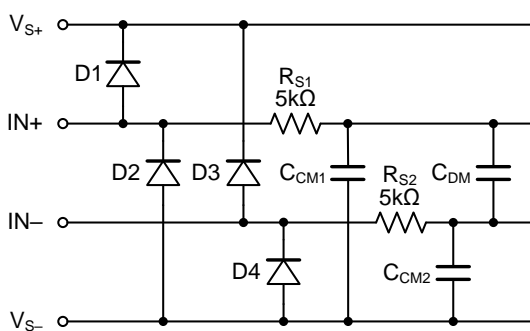

Figure 1. Input EMI Filter and Clamp Circuit

Operational amplifiers vary in susceptibility to EMI. If conducted EMI enters the operational amplifier, the dc offset at the amplifier output can shift from its nominal value when EMI is present. This shift is a result of signal rectification associated with the internal semiconductor junctions. Although all operational amplifier pin functions can be affected by EMI, the input pins are likely to be the most susceptible. The EMI filter of the SL860x family is

## Application Notes (continued)

composed of two 5-k $\Omega$  input series resistors ( $R_{S1}$  and  $R_{S2}$ ), two common-mode capacitors ( $C_{CM1}$  and  $C_{CM2}$ ), and a differential capacitor ( $C_{DM}$ ). These RC networks set the -3 dB low-pass cutoff frequencies at 35-MHz for common-mode signals, and at 22-MHz for differential signals.

### RAIL-TO-RAIL OUTPUT

Designed as a micro-power, low-noise operational amplifier, the SL860x delivers a robust output drive capability. A class AB output stage with common-source transistors is used to achieve full rail-to-rail output swing capability. For resistive loads up to 100-k $\Omega$ , the output swings typically to within 5-mV of either supply rail regardless of the power-supply voltage applied. Different load conditions change the ability of the amplifier to swing close to the rails. For resistive loads up to 600- $\Omega$ , the output swings typically to within 125-mV of the positive supply rail and within 90-mV of the negative supply rail.

### CAPACITIVE LOAD AND STABILITY

The SL860x family can safely drive capacitive loads of up to 300-pF in any configuration. As with most amplifiers, driving larger capacitive loads than specified may cause excessive overshoot and ringing, or even oscillation. A heavy capacitive load reduces the phase margin and causes the amplifier frequency response to peak. Peaking corresponds to overshooting or ringing in the time domain. Therefore, it is recommended that external compensation be used if the SL860x op-amps must drive a load exceeding 300-pF. This compensation is particularly important in the unity-gain configuration, which is the worst case for stability.

A quick and easy way to stabilize the op-amp for capacitive load drive is by adding a series resistor,  $R_{ISO}$ , between the amplifier output terminal and the load capacitance, as shown in Figure 2.  $R_{ISO}$  isolates the amplifier output and feedback network from the capacitive load. The bigger the  $R_{ISO}$  resistor value, the more stable  $V_{OUT}$  will be. Note that this method results in a loss of gain accuracy because  $R_{ISO}$  forms a voltage divider with the  $R_L$ .

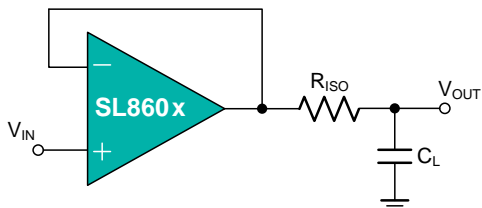

Figure 2. Indirectly Driving Heavy Capacitive Load

An improvement circuit is shown in Figure 3. It provides DC accuracy as well as AC stability. The  $R_F$  provides the DC accuracy by connecting the inverting

signal with the output.

The  $C_F$  and  $R_{ISO}$  serve to counteract the loss of phase margin by feeding the high frequency component of the output signal back to the amplifier's inverting input, thereby preserving phase margin in the overall feedback loop.

For no-buffer configuration, there are two others ways to increase the phase margin: (a) by increasing the amplifier's gain, or (b) by placing a capacitor in parallel with the feedback resistor to counteract the parasitic capacitance associated with inverting node.

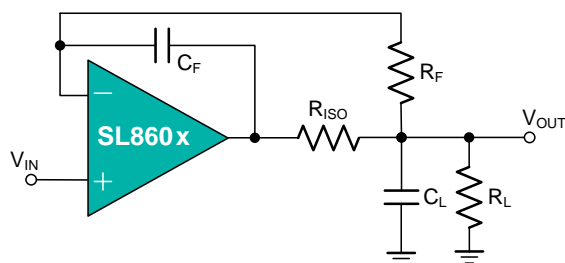

Figure 3. Indirectly Driving Heavy Capacitive Load with DC Accuracy

### OVERLOAD RECOVERY

Overload recovery is defined as the time required for the operational amplifier output to recover from a saturated state to a linear state. The output devices of the operational amplifier enter a saturation region when the output voltage exceeds the rated operating voltage, either because of the high input voltage or the high gain. After the device enters the saturation region, the charge carriers in the output devices require time to return back to the linear state. After the charge carriers return back to the linear state, the device begins to slew at the specified slew rate. Thus, the propagation delay in case of an overload condition is the sum of the overload recovery time and the slew time. The overload recovery time for the SL860x family is approximately 0.3- $\mu$ s.

### EMI REJECTION RATIO

Circuit performance is often adversely affected by high frequency EMI. When the signal strength is low and transmission lines are long, an op-amp must accurately amplify the input signals. However, all op-amp pins — the non-inverting input, inverting input, positive supply, negative supply, and output pins — are susceptible to EMI signals. These high frequency signals are coupled into an op-amp by various means, such as conduction, near field radiation, or far field radiation. For example, wires and printed circuit board (PCB) traces can act as antennas and pick up high frequency EMI signals.

## Application Notes (continued)

Amplifiers do not amplify EMI or RF signals due to their relatively low bandwidth. However, due to the nonlinearities of the input devices, op-amps can rectify these out of band signals. When these high frequency signals are rectified, they appear as a dc offset at the output.

The SL860x op-amps have integrated EMI filters at their input stage. A mathematical method of measuring EMIRR is defined as follows:

$$EMIRR = 20 \log (V_{IN\_PEAK} / \Delta V_{OS})$$

### INPUT-TO-OUTPUT COUPLING

To minimize capacitive coupling, the input and output signal traces should not be parallel. This helps reduce unwanted positive feedback.

### MAXIMIZING PERFORMANCE THROUGH PROPER LAYOUT

To achieve the maximum performance of the extremely high input impedance and low offset voltage of the SL860x op-amps, care is needed in laying out the circuit board. The PCB surface must remain clean and free of moisture to avoid leakage currents between adjacent traces. Surface coating of the circuit board reduces surface moisture and provides a humidity barrier, reducing parasitic resistance on the board. The use of guard rings around the amplifier inputs further reduces leakage currents. Figure 4 shows proper guard ring configuration and the top view of a surface-mount layout. The guard ring does not need to be a specific width, but it should form a continuous loop around both inputs. By setting the guard ring voltage equal to the voltage at the non-inverting input, parasitic capacitance is minimized as well. For further reduction of leakage currents, components can be mounted to the PCB using Teflon standoff insulators.

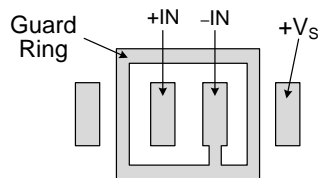

Figure 4. Use a guard ring around sensitive pins

Other potential sources of offset error are thermoelectric voltages on the circuit board. This voltage, also called Seebeck voltage, occurs at the junction of two dissimilar metals and is proportional to the temperature of the junction. The most common metallic junctions on a circuit board are solder-to-board trace and solder-to-component lead. If the temperature of the PCB at one end of the component is different from the temperature at the other end, the resulting Seebeck voltages are not equal,

resulting in a thermal voltage error.

This thermocouple error can be reduced by using dummy components to match the thermoelectric error source. Placing the dummy component as close as possible to its partner ensures both Seebeck voltages are equal, thus canceling the thermocouple error. Maintaining a constant ambient temperature on the circuit board further reduces this error. The use of a ground plane helps distribute heat throughout the board and reduces EMI noise pickup.

## Typical Application Circuits

### ACTIVE FILTER

The SL860x family is well-suited for active filter applications that require a wide bandwidth, fast slew rate, low-noise, single-supply operational amplifier. Figure 5 shows a 500-kHz, second-order, low-pass filter using the multiple-feedback (MFB) topology. The components have been selected to provide a maximally-flat Butterworth response. Beyond the cut-off frequency, roll-off is  $-40$  dB/dec. The Butterworth response is ideal for applications that require predictable gain characteristics, such as the anti-aliasing filter used in front of an ADC.

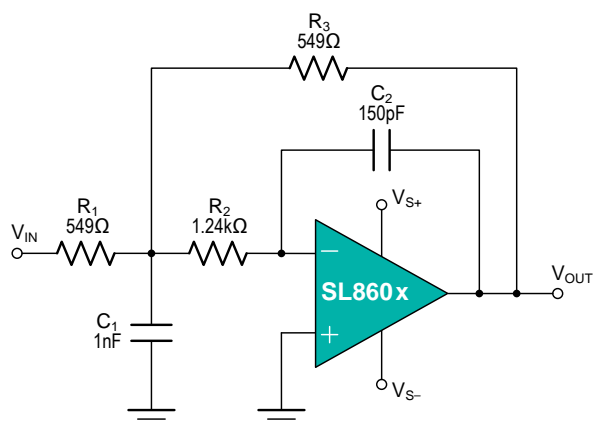

Figure 5. Second-Order, Butterworth, 500-kHz Low-Pass Filter

One point to observe when considering the MFB filter is that the output is inverted, relative to the input. If this inversion is not required, or not desired, a non-inverting output can be achieved through one of these options:

1. adding an inverting amplifier;
2. adding an additional second-order MFB stage; or
3. using a non-inverting filter topology, such as the Sallen-Key (shown in Figure 6).

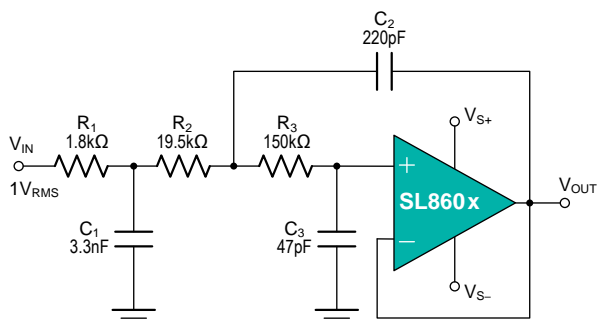

Figure 6. Configured as a Three-Pole, 20-kHz, Sallen-Key Filter

### MOTOR PHASE CURRENT SENSING

The current sensing amplification shown in Figure 7 has a slew rate of  $2\pi fV_{pp}$  for the output of sine wave signal, and has a slew rate of  $2fV_{pp}$  for the output of triangular wave signal. In most of motor control systems, the PWM frequency is at 10 kHz to 20 kHz, and one cycle time is  $100 \mu s$  for a 10 kHz of PWM frequency. In current shunt monitoring for a motor phase, the phase current is converted to a phase voltage signal for ADC sampling. This sampling voltage signal must be settled before entering the ADC. As the Figure 7 shown, the total settling time of a current shunt monitor circuit includes: the rising edge delay time ( $t_{SR}$ ) due to the op-amp's slew rate, and the measurement settling time ( $t_{SET}$ ). For a 2-shunt solution of motor phase current sensing, if the minimum duty cycle of the PWM is defined at 5%, and the  $t_{SR}$  is required at 20% of a total time window for a phase current monitoring, in case of a 3.3 V motor control system (3.3 V MCU with 12-bit ADC), the op-amp's slew rate should be more than:

$$3.3V / (100\mu s \times 5\% \times 20\%) = 3.3 V/\mu s$$

At the same time, the op-amp's bandwidth should be much greater than the PWM frequency, like 10 times at least.

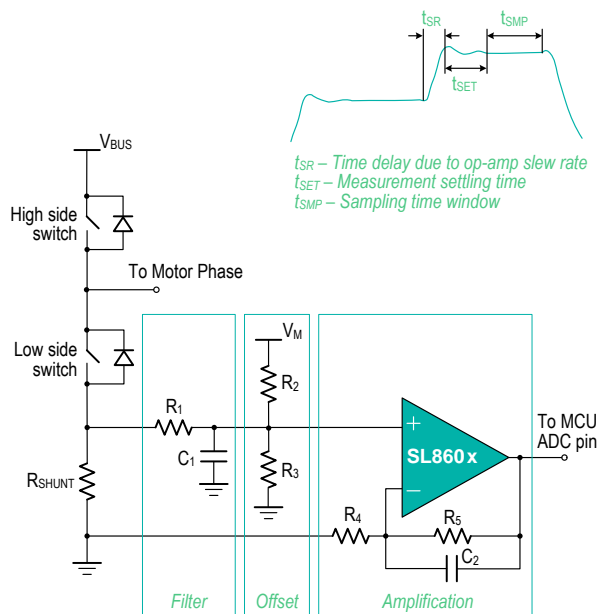

Figure 7. Current Shunt Monitor Circuit

### DIFFERENTIAL AMPLIFIER

The circuit shown in Figure 8 performs the difference function. If the resistors ratios are equal  $R_4/R_3 = R_2/R_1$ , then:

$$V_{OUT} = (V_p - V_n) \times R_2/R_1 + V_{REF}$$

## Typical Application Circuits (continued)

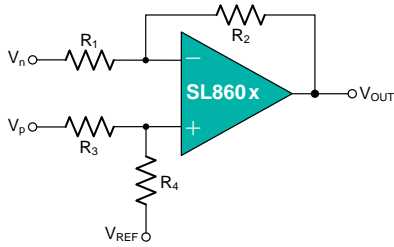

Figure 8. Differential Amplifier

low-leakage cables that that is required to connect a pH probe (general purpose combination pH probes, e.g Corning 476540) to metering ICs such as ADC, AFE and/or MCU. A SL860x op-amp and a lithium battery are housed in the probe assembly. A conventional low-cost coaxial cable can be used to carry the op-amp's output signal to subsequent ICs for pH reading.

### INSTRUMENTATION AMPLIFIER

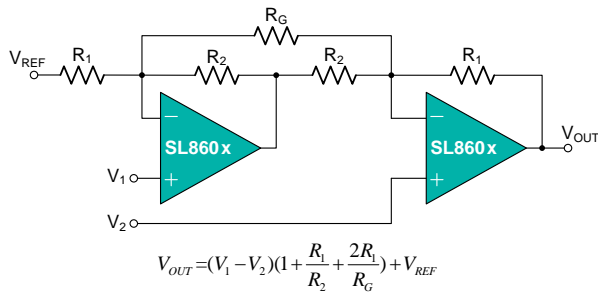
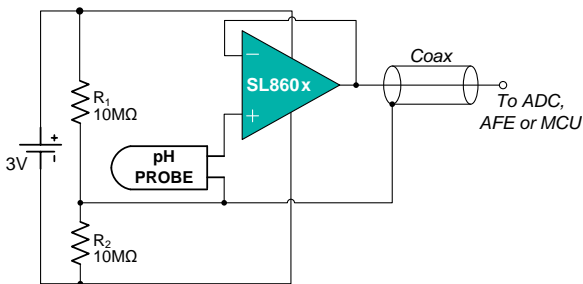

Figure 9. Instrumentation Amplifier

The SL860x family is well suited for conditioning sensor signals in battery-powered applications. Figure 9 shows a two op-amp instrumentation amplifier, using the SL860x op-amps. The circuit works well for applications requiring rejection of common-mode noise at higher gains. The reference voltage ( $V_{REF}$ ) is supplied by a low-impedance source. In single voltage supply applications, the  $V_{REF}$  is typically  $V_S/2$ .

### BUFFERED CHEMICAL SENSORS



All components contained within the pH probe

Figure 10. Buffered pH Probe

The SL860x family has input bias current in the pA range. This is ideal in buffering high impedance chemical sensors, such as pH probes. As an example, the circuit in Figure 10 eliminates expensive

## Package Outlines

### DIMENSIONS, SOT23-5L

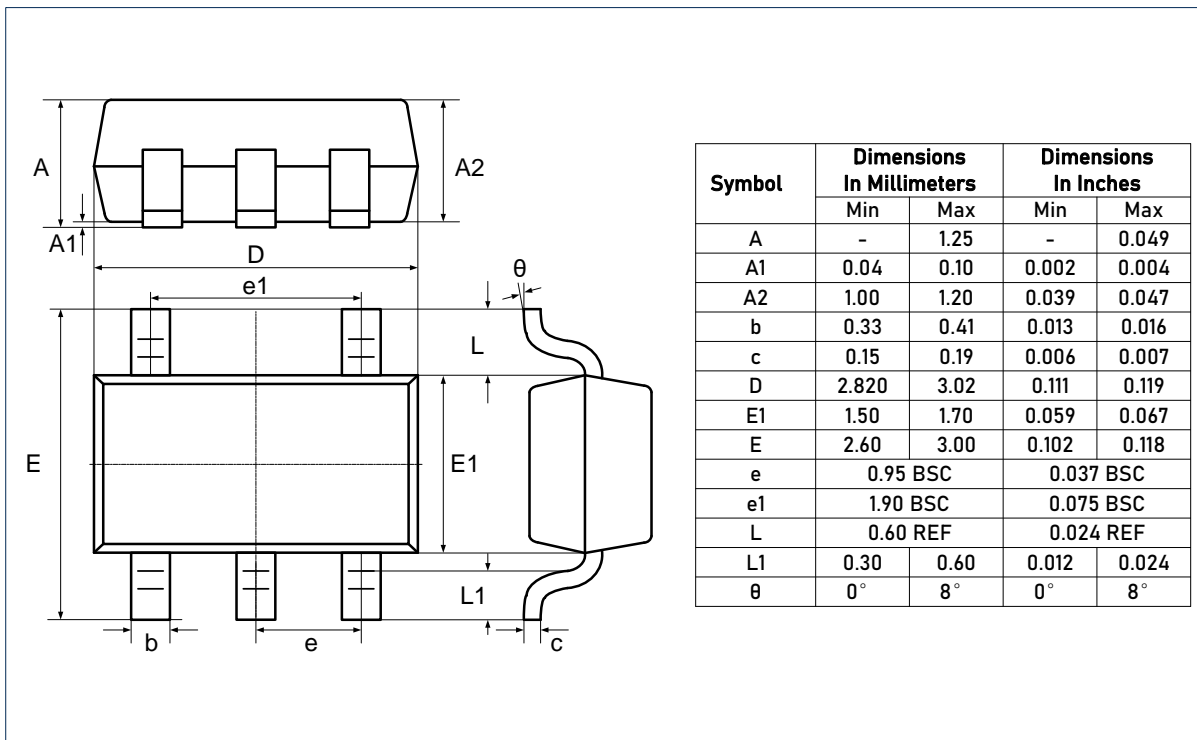

### RECOMMENDED SOLDERING FOOTPRINT, SOT23-5L

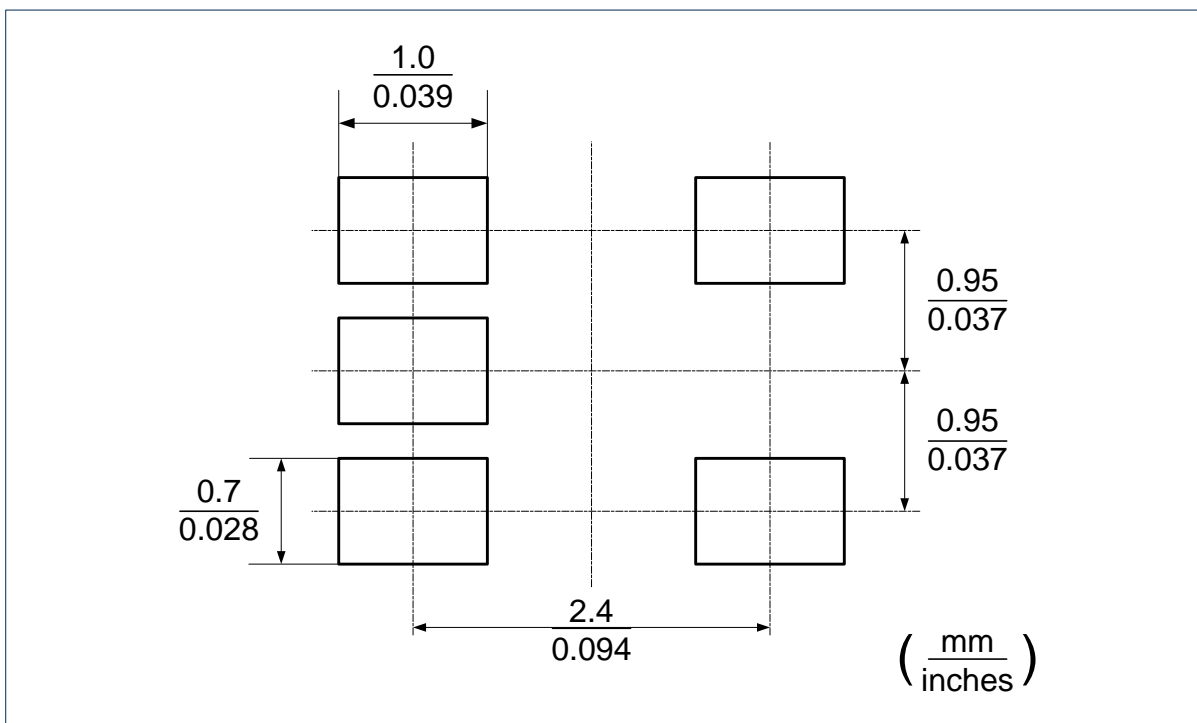

## Package Outlines (continued)

### DIMENSIONS, SC70-5L (SOT353)

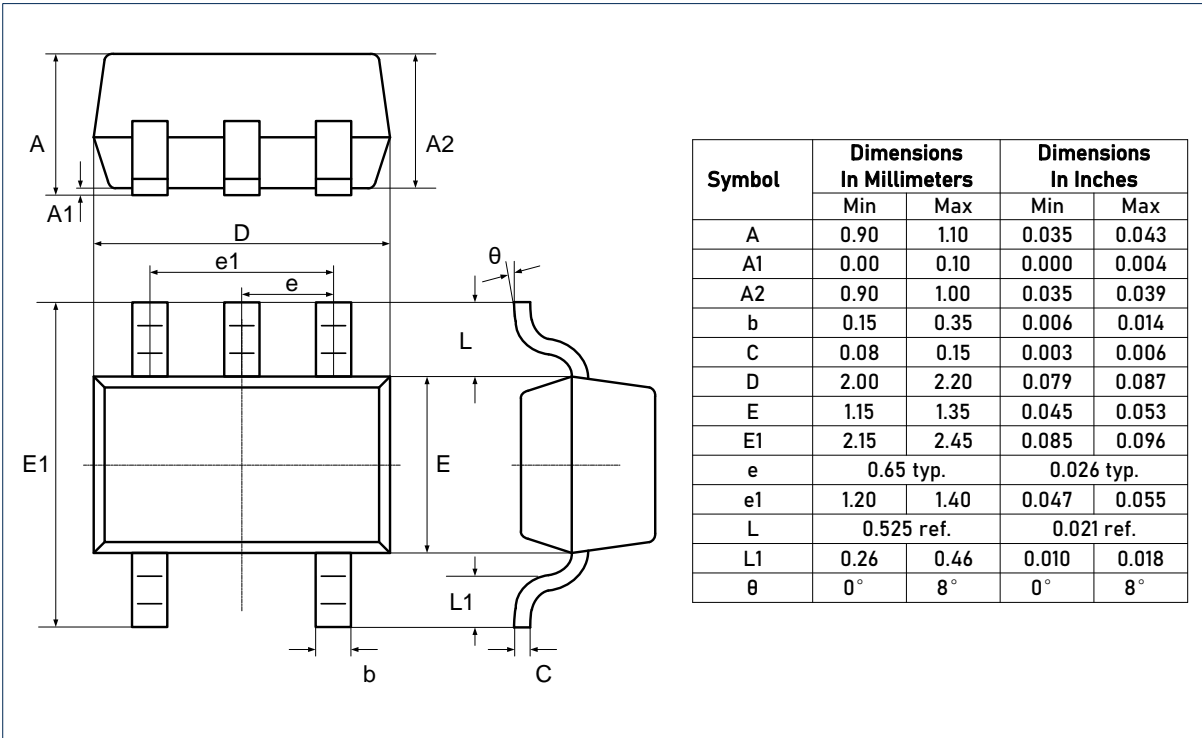

### RECOMMENDED SOLDERING FOOTPRINT, SC70-5L (SOT353)

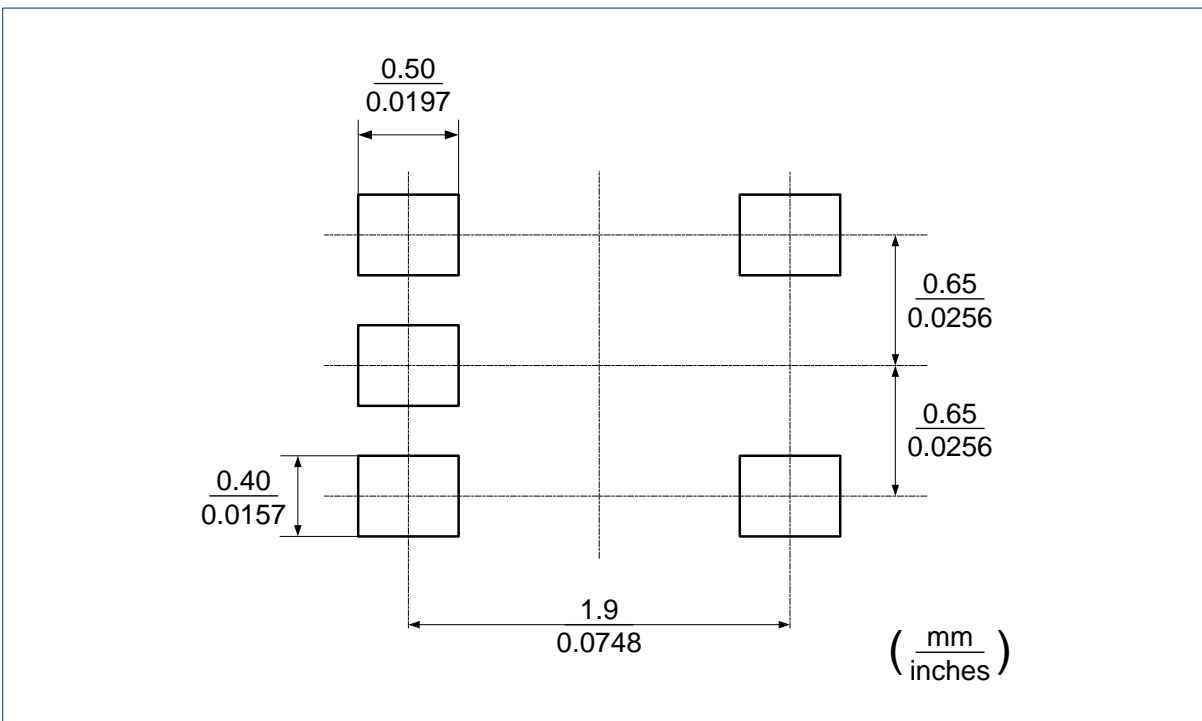

## Package Outlines (continued)

DIMENSIONS, DFN2x2-8L

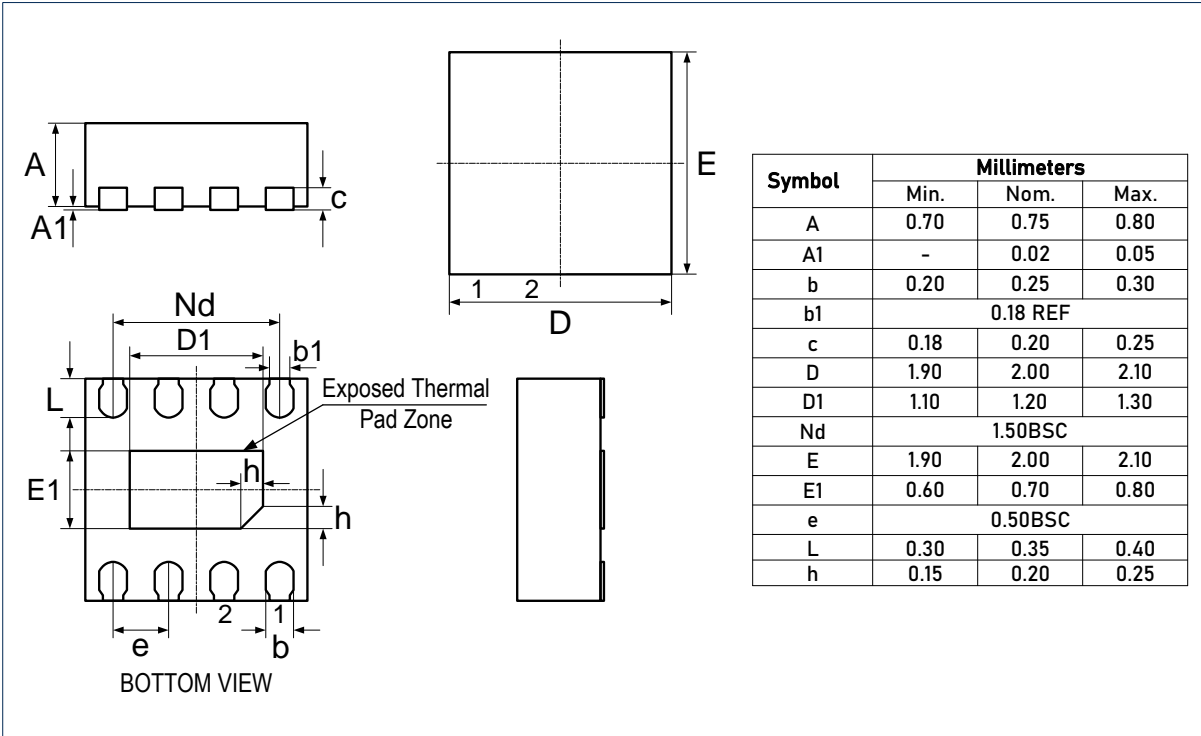

RECOMMENDED SOLDERING FOOTPRINT, DFN2x2-8L

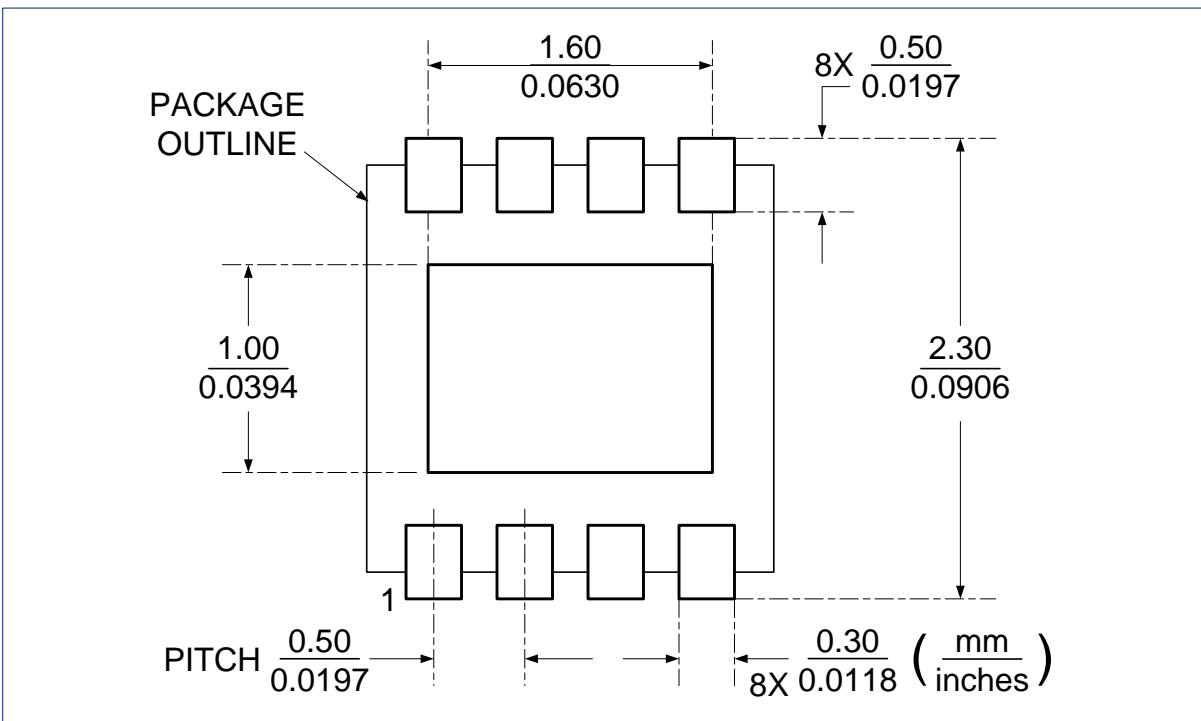



## Package Outlines (continued)

### DIMENSIONS, SOIC-8L

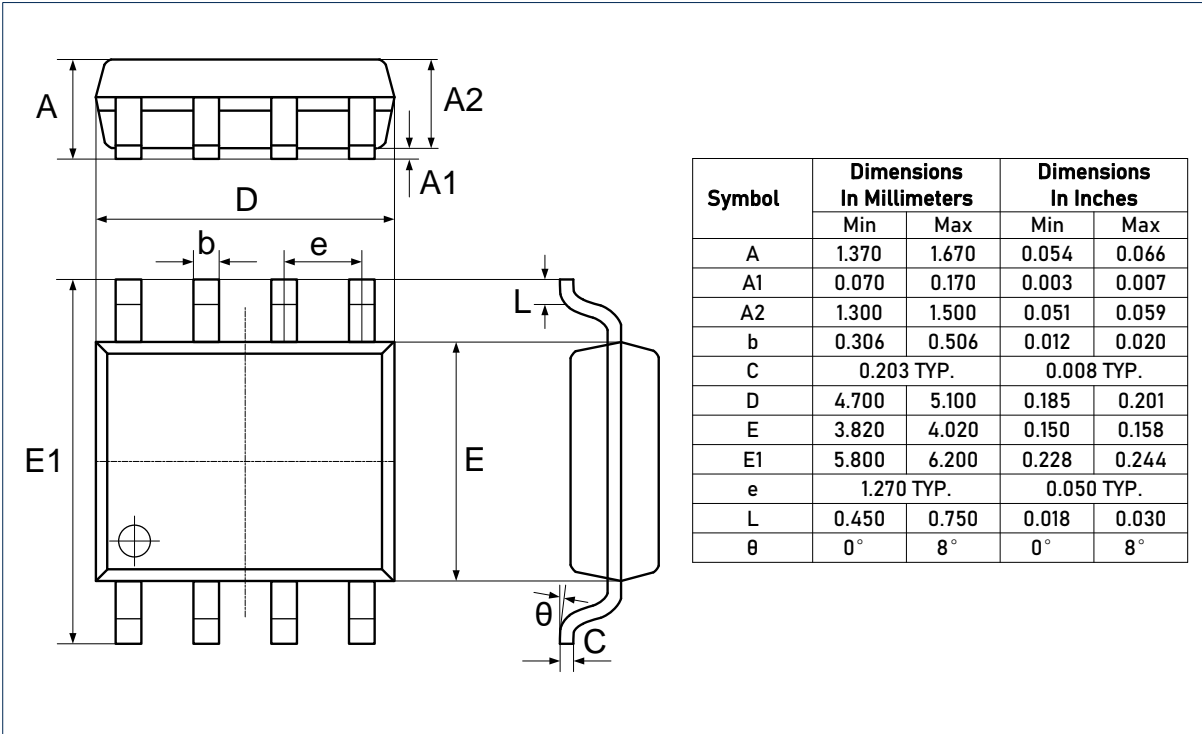

### RECOMMENDED SOLDERING FOOTPRINT, SOIC-8L

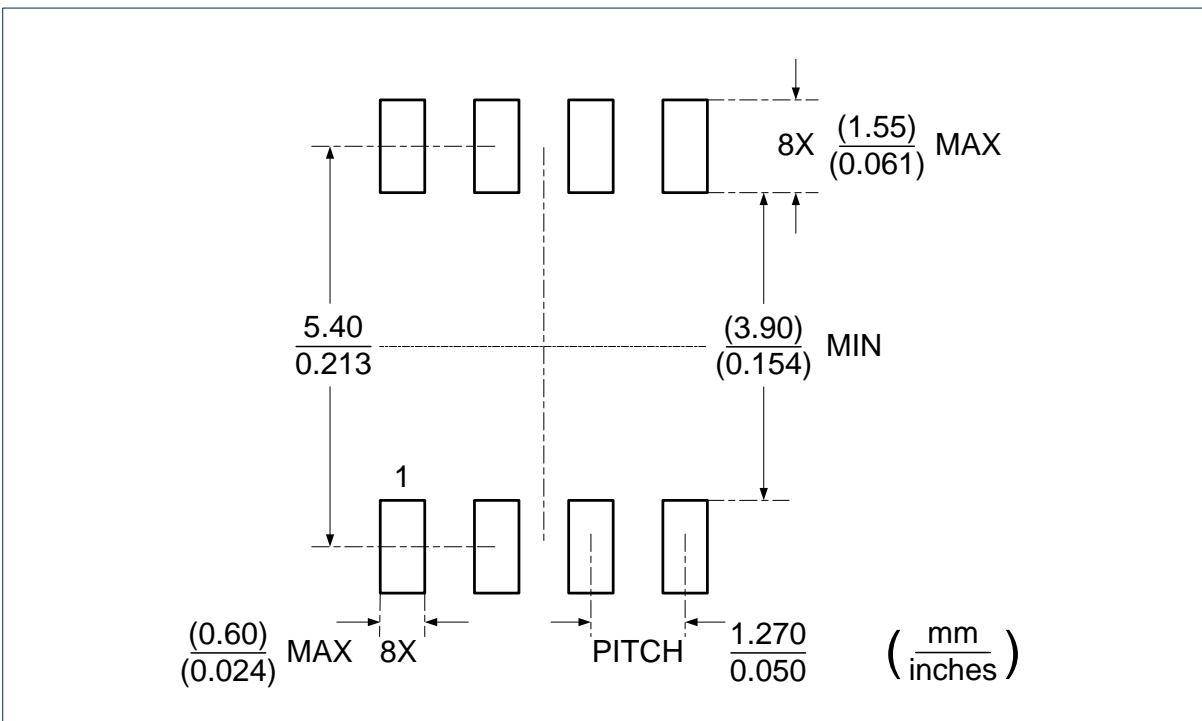

## Package Outlines (continued)

### DIMENSIONS, MSOP-8L

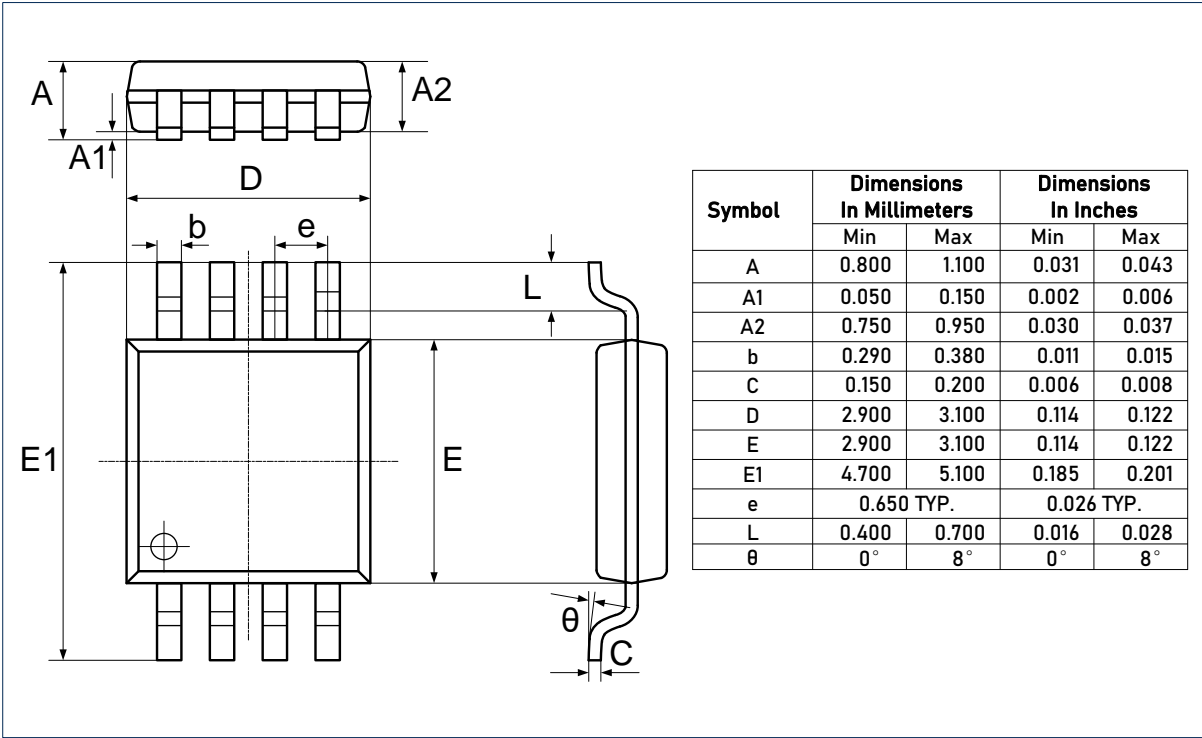

### RECOMMENDED SOLDERING FOOTPRINT, MSOP-8L

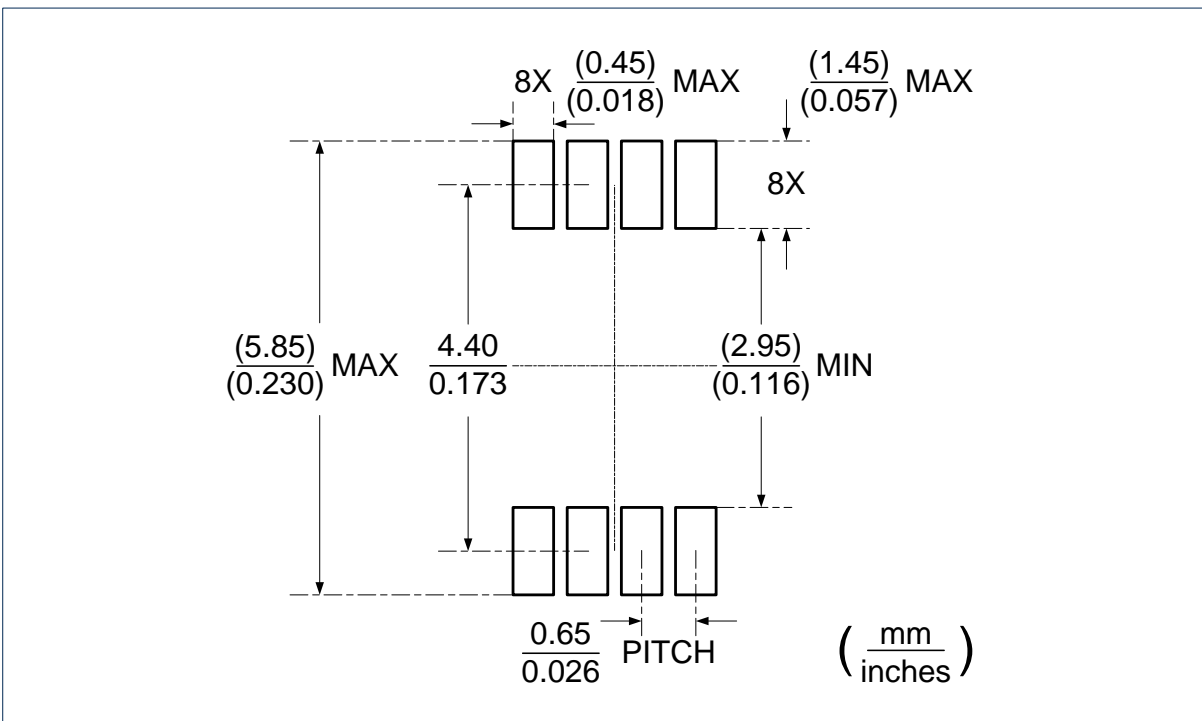

## Package Outlines (continued)

### DIMENSIONS, TSSOP-8L

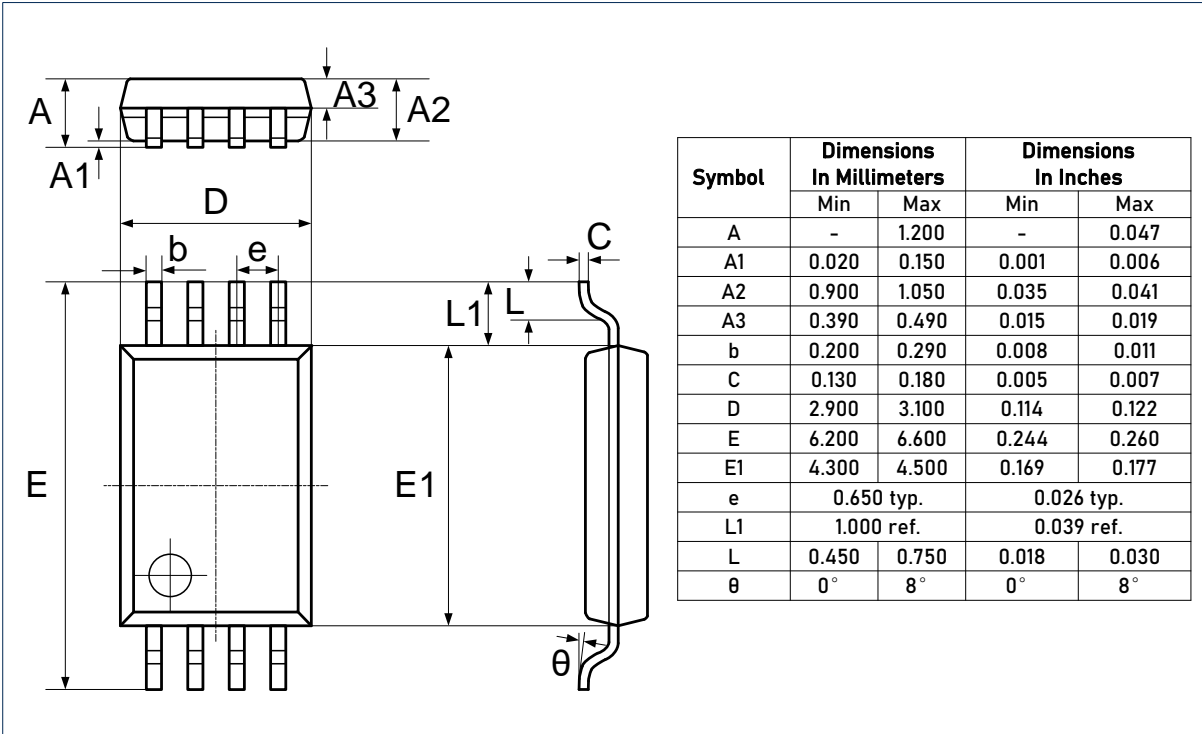

### RECOMMENDED SOLDERING FOOTPRINT, TSSOP-8L

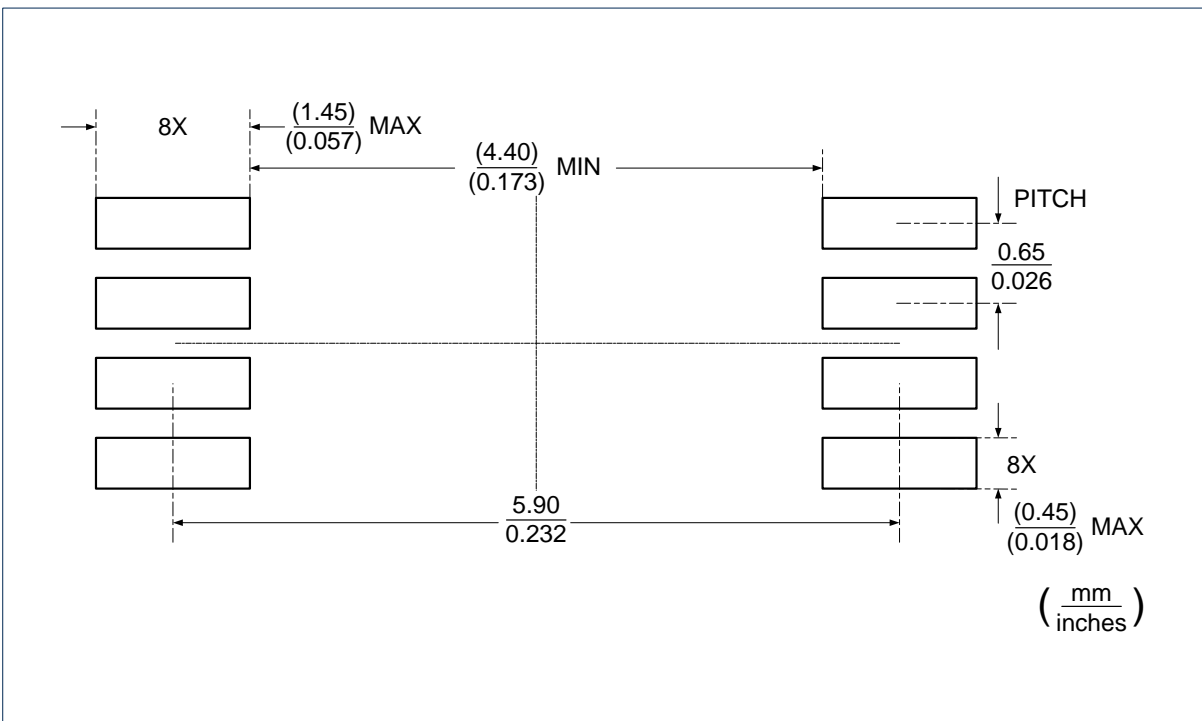

## Package Outlines (continued)

### DIMENSIONS, SOIC-14L

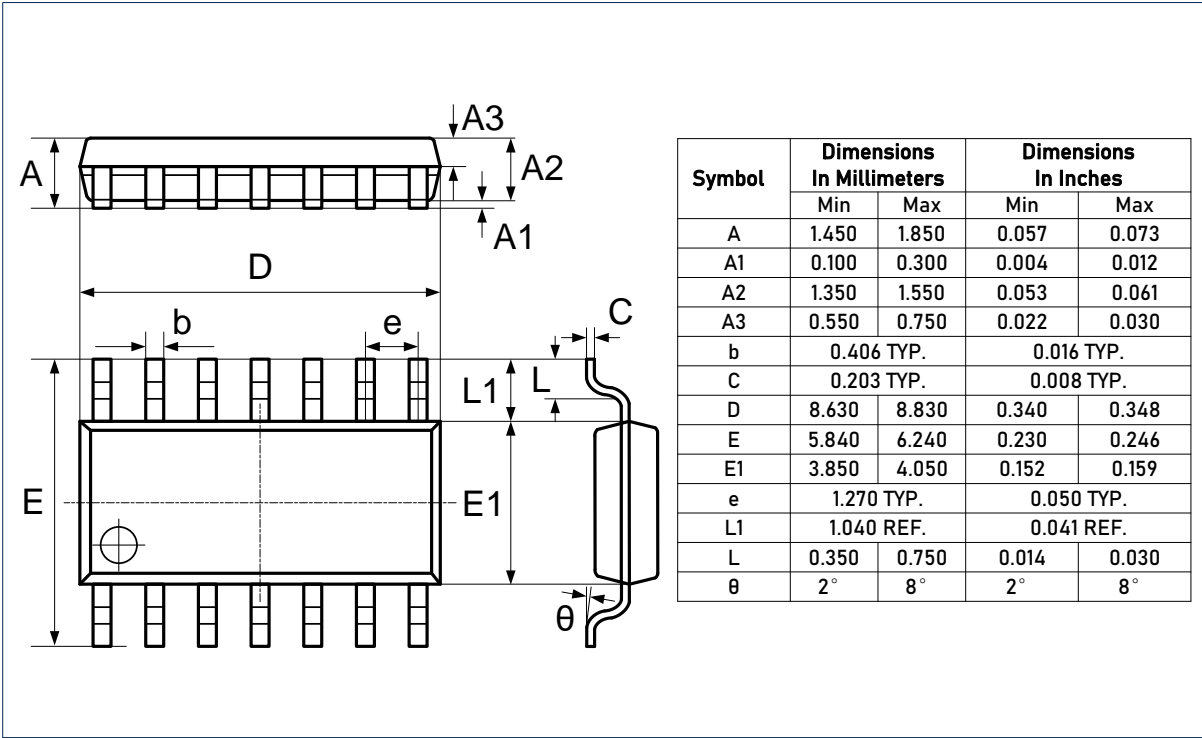

### RECOMMENDED SOLDERING FOOTPRINT, SOIC-14L

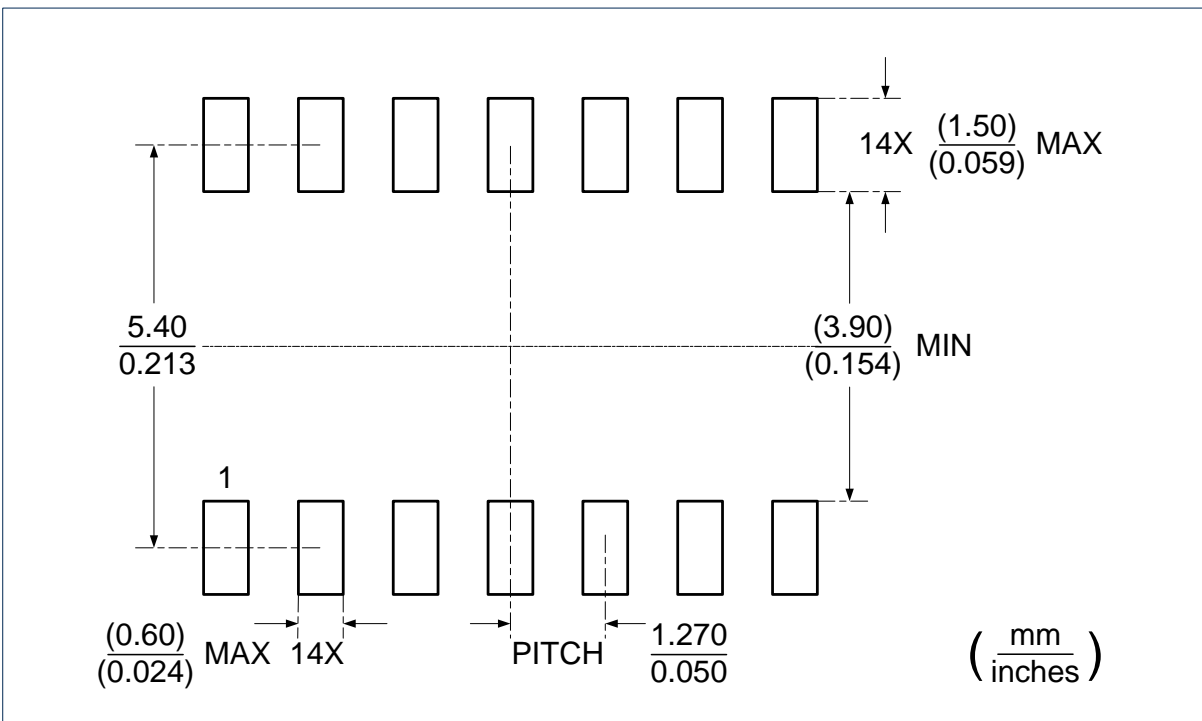

## Package Outlines

DIMENSIONS, QFN3x3-16L

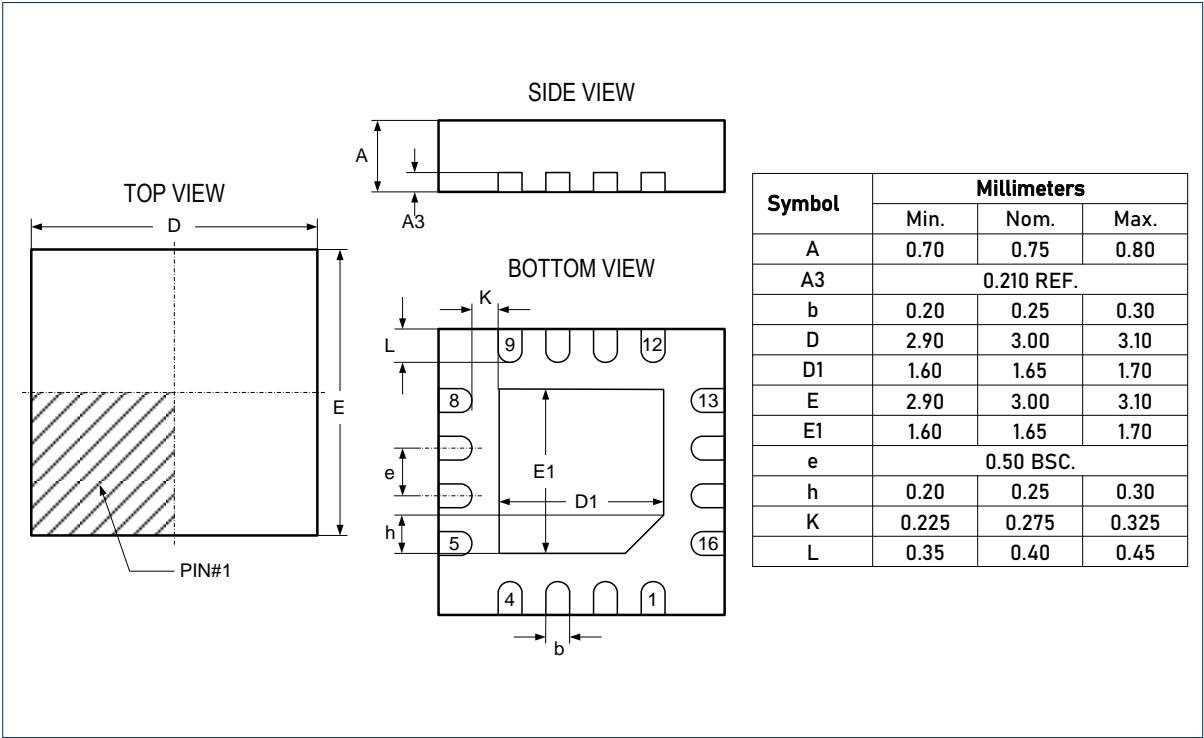

RECOMMENDED SOLDERING FOOTPRINT, QFN3x3-16L

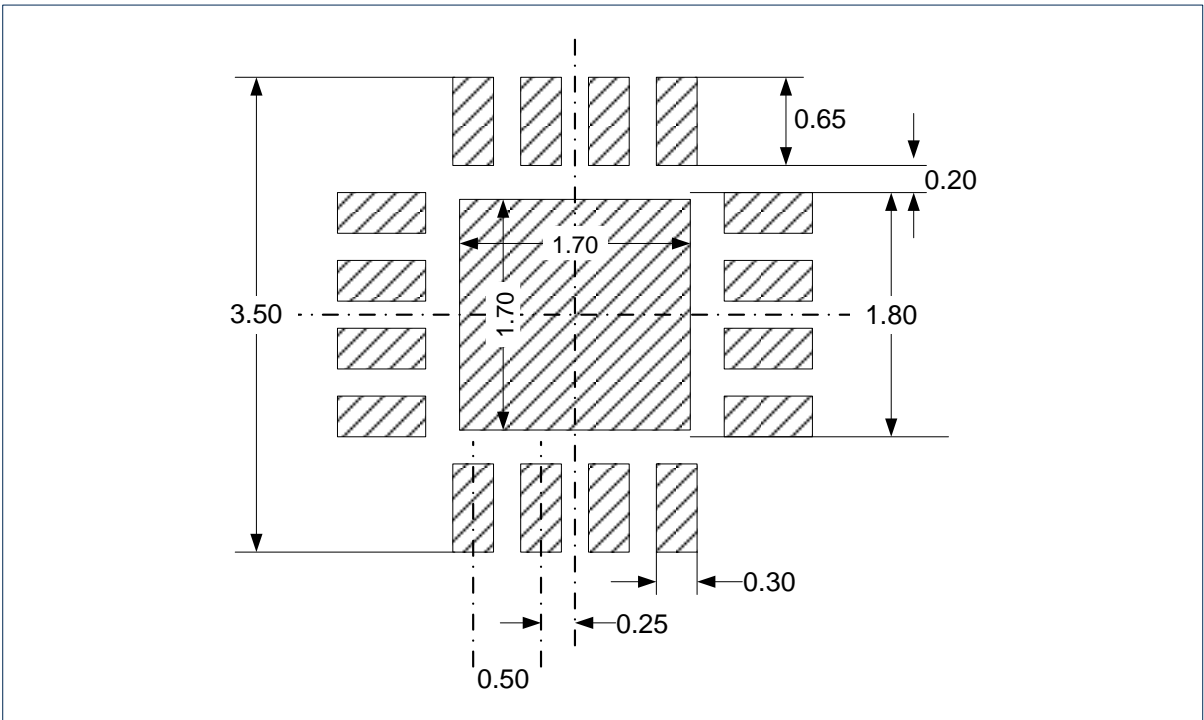

## Package Outlines (continued)

### DIMENSIONS, TSSOP-14L

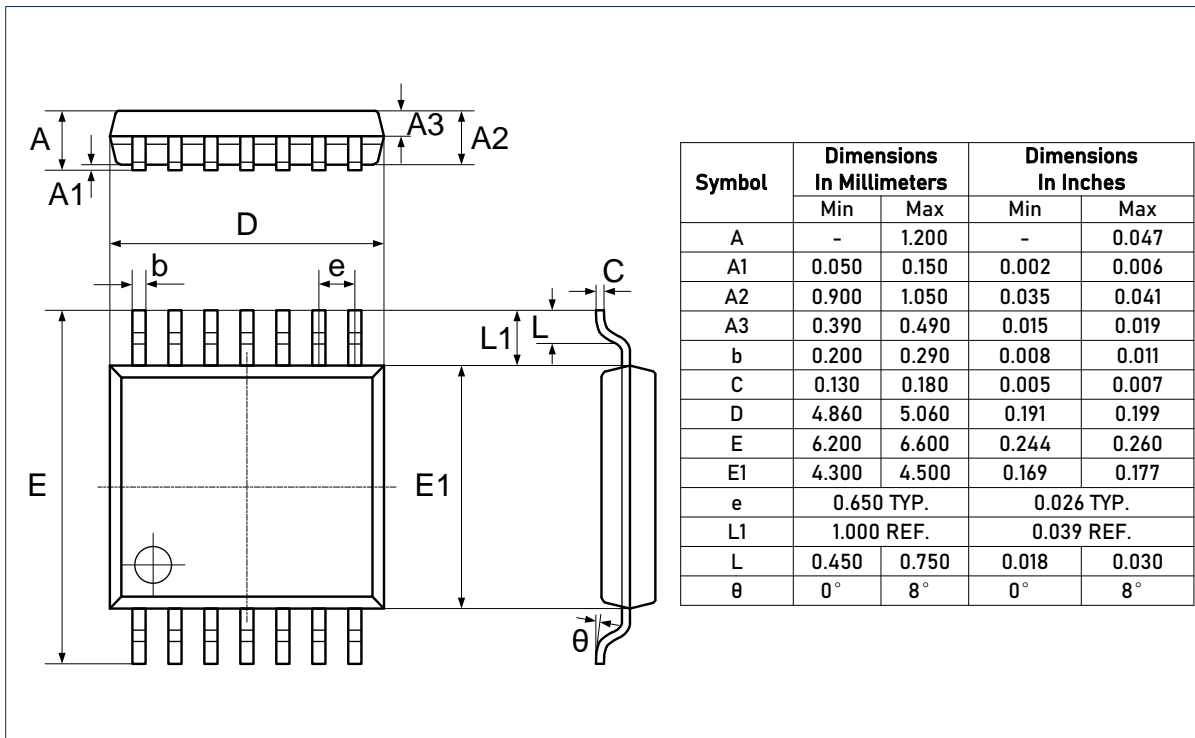

### RECOMMENDED SOLDERING FOOTPRINT, TSSOP-14L

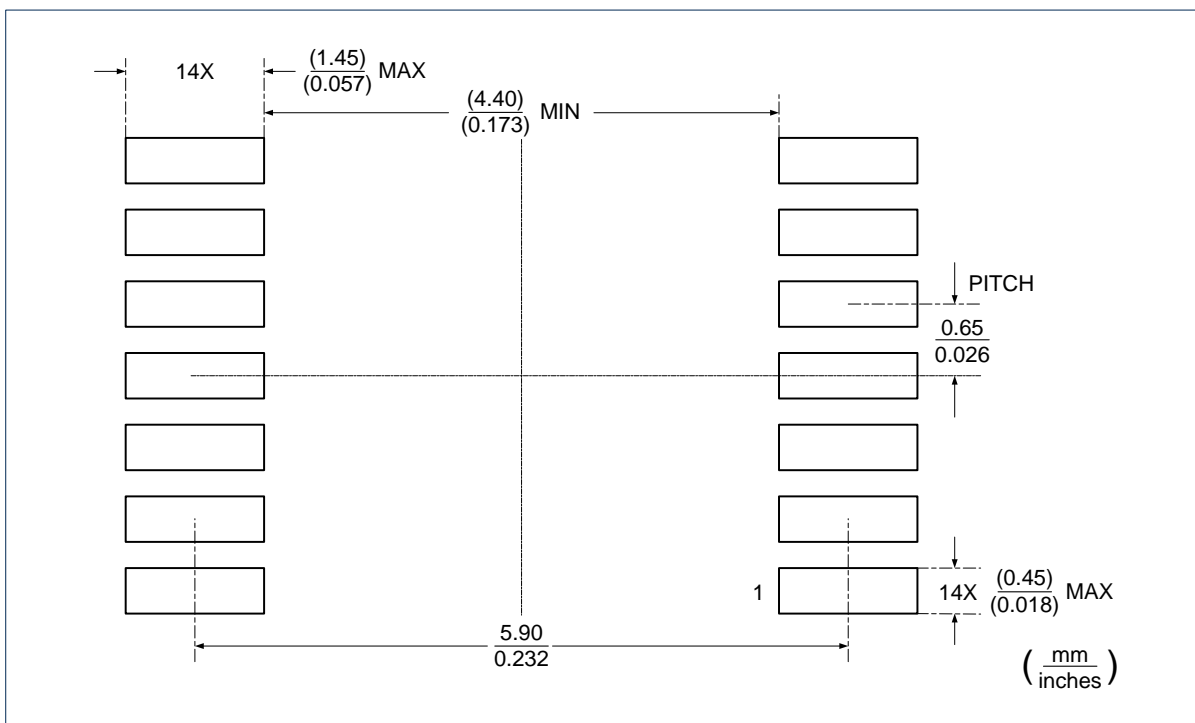

## X-ON Electronics

Largest Supplier of Electrical and Electronic Components

*Click to view similar products for [Precision Amplifiers](#) category:*

*Click to view products by [SLKORMICRO](#) manufacturer:*

Other Similar products are found below :

[LM201AN](#) [MCP6V52-E/MS](#) [ADA4692-4ARUZ-RL](#) [EL8176FSZ](#) [ISL28158FHZ-T7](#) [ISL28236FBZ](#) [ISL28236FBZ-T7](#) [ISL28258FUZ](#)  
[ISL28258FUZ-T7](#) [ISL28276FBZ](#) [ISL28276IAZ](#) [ISL28276IAZ-T7](#) [ISL28288FUZ](#) [NCS21914DR2G](#) [NCS21914DTBR2G](#) [RS8654XP](#)  
[AD8615AUJZ-REEL](#) [HG2376M/TR](#) [MS8362M](#) [LT1013IS8#TRPBF](#) [ADA4610-4ARZ-R7](#) [TP5591-TR](#) [AD8652ARZ-REEL](#) [AD8639ARZ-](#)  
[REEL](#) [ADA4622-2ARZ-RL](#) [LTC6241HVCS8#TRPBF](#) [LT6011IS8#TRPBF](#) [LT6230IS6-10#TRPBF](#) [LT6011IMS8#TRPBF](#)  
[LTC6246CS6#TRMPBF](#) [LT6230CS6#TRPBF](#) [LTC2054HS5#TRPBF](#) [LT6235IGN#TRPBF](#) [LTC6362IDD#TRPBF](#) [AD8625ARUZ-REEL](#)  
[LTC2050HVIS8#TRPBF](#) [AD8627AKSZ-REEL](#) [LT6220IS5#TRPBF](#) [OP213ESZ-REEL](#) [ADA4092-4ARUZ-RL](#) [CBM8532AMS8](#)  
[CBM8628AST5](#) [CBM8534AS14](#) [CBM8608AS14](#) [CBM8534ATS14](#) [CBM8629AS8](#) [CBM8608ATS14](#) [CBM8606AS8](#) [COS8552WSRA](#)  
[COS8552WSRC](#)