

## 1. Features

- Ultra-Low capacitance:0.05pF(typ.)
- Low leakage current(<10nA)
- Fast response time(<1ns)
- Bi-directional, single line protection
- IEC 61000-4-2 (ESD Air): 15kV  
IEC 61000-4-2 (ESD Contact): 8kV

## 2. Pin Description

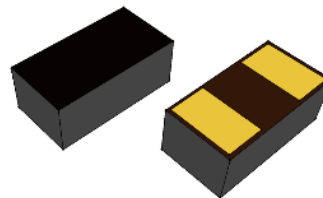

## 3. Applications

- USB 3.0/3.1
- HDMI 1.3/1.4/2.0
- RF Antenna
- SATA and eSATA Interface

## 4. Schematic Diagram



## 5. Order Information

Type	Package	Size (mm)	Delivery Form	Delivery Quantity
SLPESD0402-30	0402	1.00x0.52x0.38	7" T&R	10,000

## 6. Limiting Values( $T_A = 25\text{ }^\circ\text{C}$ , unless otherwise specified)

Symbol	Parameter	Conditions	Min	Max	Unit
$V_{ESD}$	Electrostatic Discharge Voltage	IEC 61000-4-2; Contact Discharge	-	8	kV
		IEC 61000-4-2; Air Discharge	-	15	kV
$T_A$	Operating Temperature Range	-	-55	125	$^\circ\text{C}$
$T_{stg}$	Storage Temperature Range	-	-40	85	$^\circ\text{C}$

## 7. Electrical Characteristics( $T_A = 25\text{ }^\circ\text{C}$ unless otherwise specified)

Symbol	Parameter	Conditions	Min	Typ.	Max	Unit
$V_{DC}$	Continuous Operating Voltage	-	-	-	30	V
$V_T$	Trigger Voltage	IEC61000-4-2 8kV contact discharge	-	450	-	V
$V_C$	Clamping Voltage	IEC61000-4-2 8kV contact discharge	-	40	-	V
$I_L$	Leakage Current	DC 30V shall be applied on component	-	-	10	nA
$C_J$	Capacitance	Measured at 10MHz	-	0.05	-	pF

### 8. Typical Characteristics

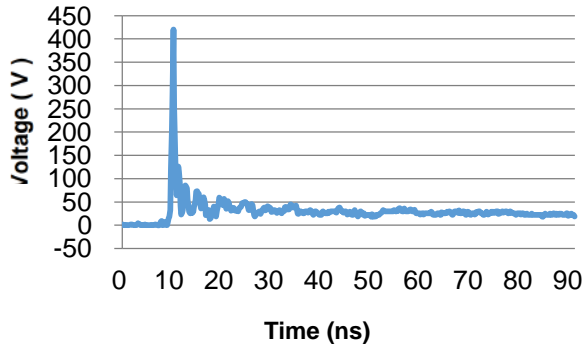

Fig.1 Typical ESD Response  
(IEC 61000-4-2, 8kV contact discharge)

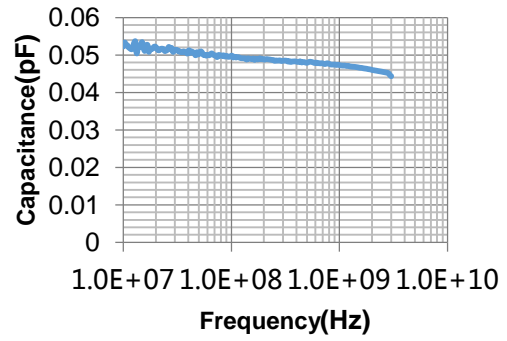

Fig.2 Typical Device Capacitance VS. Frequency

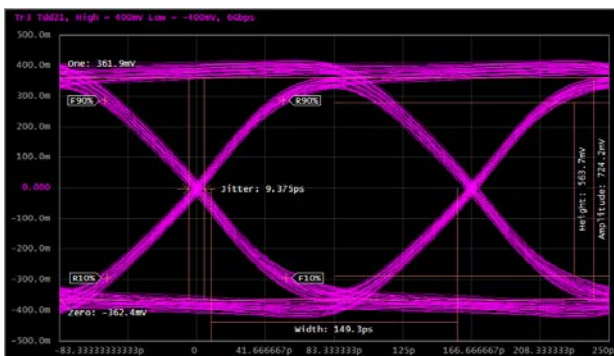
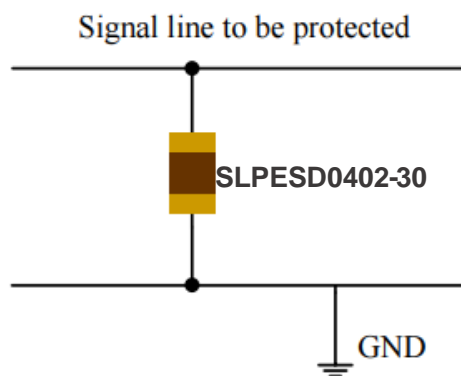
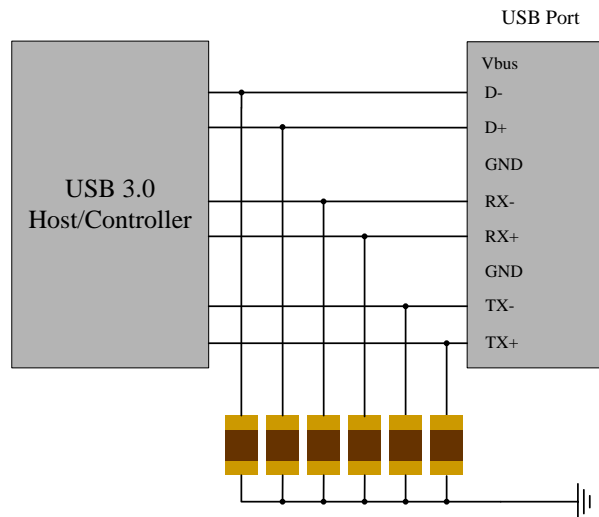

Fig.3 HDMI 2.0 Mask at 6.0 Gbps

## 9. ESD Protection for Signal Line

The SLPESD is designed for the protection of one bidirectional data line from ESD damage.

- Place the SLPESD as close to the input terminal or connector as possible.
- Minimize the path length between the SLPESD and the protected signal line.
- Use ground planes whenever possible.



10. Package Dimension

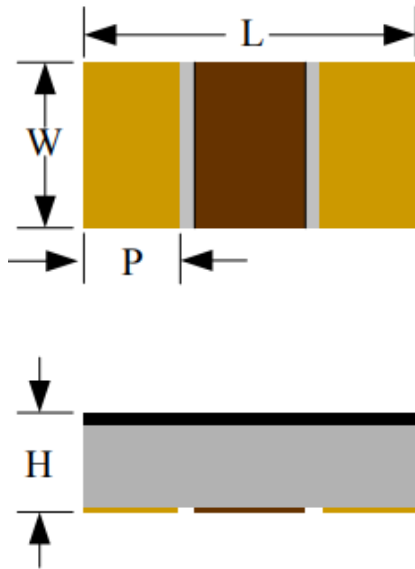

Recommended Solder Pad Footprint

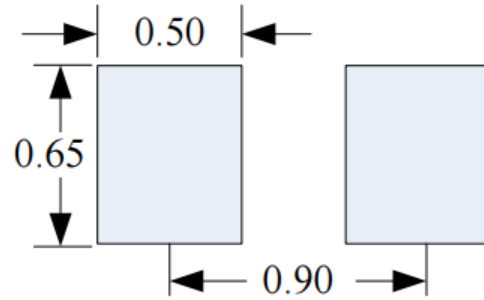

**\*Sizes in mm**

Notes:

This solder pad layout is for reference purposes only.

Dimension	Unit: Millimeters	
	Min.	Max.
L	0.90	1.10
W	0.42	0.62
p	0.15	0.35
H	0.25	0.45

## 11. Soldering Parameters

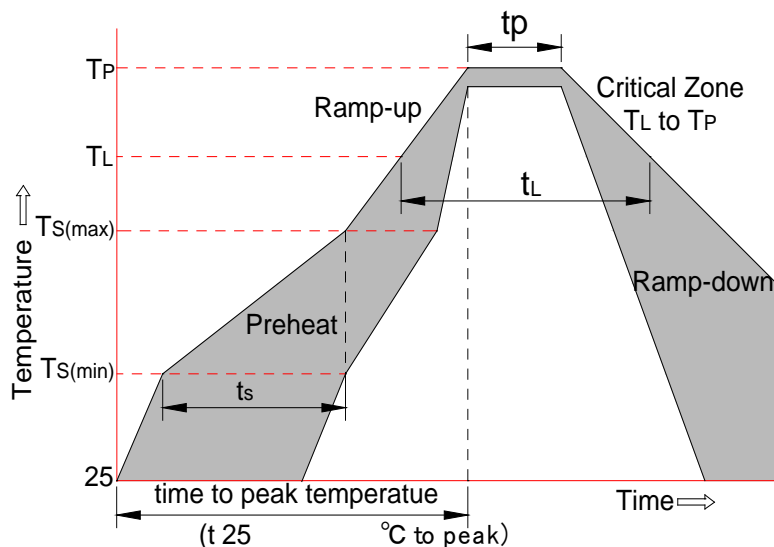

Reflow Condition		Pb-Free Assembly
Pre-heat	-Temperature Min ( $T_{s(min)}$ )	+150°C
	-Temperature Max( $T_{s(max)}$ )	+200°C
	-Time (Min to Max) ( $t_s$ )	60-180 secs.
Average ramp up rate (Liquid us Temp ( $T_L$ ) to peak)		3°C/sec. Max
$T_{s(max)}$ to $T_L$ - Ramp-up Rate		3°C/sec. Max
Reflow	-Temperature( $T_L$ )(Liquid us)	+217°C
	-Temperature( $t_L$ )	60-150 secs.
Peak Temp ( $T_p$ )		+260(+0/-5)°C
Time within 5°C of actual Peak Temp ( $t_p$ )		30 secs. Max
Ramp-down Rate		6°C/sec. Max
xTime 25°C to Peak Temp ( $T_p$ )		8 min. Max
Do not exceed		+260°C

## X-ON Electronics

Largest Supplier of Electrical and Electronic Components

*Click to view similar products for [ESD Suppressors / TVS Diodes](#) category:*

*Click to view products by [SLKORMICRO](#) manufacturer:*

Other Similar products are found below :

[60KS200C](#) [D18V0L1B2LP-7B](#) [D5V0F4U5P5-7](#) [NTE4902](#) [P4KE27CA](#) [P6KE11CA](#) [P6KE39CA-TP](#) [P6KE8.2A](#) [JANTX1N6053A](#)  
[SA110CA](#) [SA60CA](#) [SA64CA](#) [SMBJ12CATR](#) [SMBJ33CATR](#) [SMBJ8.0A](#) [ESD101-B1-02ELS E6327](#) [ESD105-B1-02EL E6327](#) [ESD112-B1-02EL E6327](#) [ESD119B1W01005E6327XTSA1](#) [ESD5V0L1B02VH6327XTSA1](#) [ESD7451N2T5G](#) [19180-510](#) [CPDT-5V0USP-HF](#)  
[3.0SMCJ33CA-F](#) [3.0SMCJ36A-F](#) [HSPC16701B02TP](#) [JANTX1N6126A](#) [JANTX1N6462](#) [JANTX1N6465](#) [USB50805e3/TR7](#)  
[D3V3Q1B2DLP3-7](#) [D55V0M1B2WS-7](#) [DRTR5V0U4SL-7](#) [SCM1293A-04SO](#) [ESD200-B1-CSP0201 E6327](#) [SM12-7](#) [SM1605E3/TR13](#)  
[SMLJ45CA-TP](#) [CEN955 W/DATA](#) [82350120560](#) [VESD12A1A-HD1-GS08](#) [CPDUR5V0R-HF](#) [CPDQC5V0U-HF](#) [CPDQC5V0USP-HF](#)  
[CPDQC5V0-HF](#) [D1213A-01LP4-7B](#) [ESD101-B1-02EL E6327](#) [824500181](#) [MMAD1108/TR13](#) [5KP100A](#)