

## DESCRIPTION

The SLPESDxxL1BA Series is designed for applications requiring transient overvoltage protection capability. They are intended for use in voltage and ESD sensitive equipment such as computers, printers, business machines, communication systems, medical equipment and other applications. These devices are ideal for situations where board space is at a premium.

This series has been specifically designed to protect sensitive components which are connected to power, data and transmission lines from overvoltage caused by ESD (electrostatic discharge), CDE (Cable Discharge Events), and EFT (electrical fast transients).

## ORDERING INFORMATION

- ✧ Device: SLPESDxxL1BA
- ✧ Package: SOD-323
- ✧ Material: Halogen free
- ✧ Packing: Tape & Reel
- ✧ Quantity per reel: 3,000pcs

## PIN CONFIGURATION

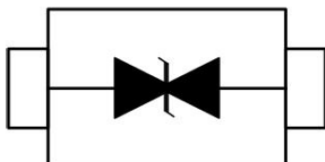

## FEATURES

- ✧ IEC61000-4-2 (ESD)  $\pm 15\text{kV}$  (air),  $\pm 8\text{kV}$  (contact)
- ✧ IEC61000-4-4 (EFT) 40A (5/50ns)
- ✧ 350 Watts Peak Pulse Power per (tp=8/20 $\mu\text{s}$ )
- ✧ Protects one I/O line (bidirectional)
- ✧ Low clamping voltage
- ✧ Working voltages : 3V, 5V, 12V, 15V, 24V
  
- ✧ Low leakage current

## MACHANICAL DATA

- ✧ SOD-323 package
- ✧ Flammability Rating: UL 94V-0
- ✧ Packaging: Tape and Reel
- ✧ High temperature soldering guaranteed: 260°C/10s
- ✧ Reel size: 7 inch
- ✧ MSL 1

## APPLICATIONS

- ✧ Cell Phone Handsets and Accessories
- ✧ Microprocessor based equipment
- ✧ Personal Digital Assistants (PDA's)
- ✧ Notebooks, Desktops, and Servers
- ✧ Portable Instrumentation
- ✧ Networking and Telecom
- ✧ Serial and Parallel Ports.
- ✧ Peripherals

## PACKAGE OUTLINE





# SLPESDxxL1BA

ABSOLUTE MAXIMUM RATING			
Symbol	Parameter	Value	Units
$V_{ESD}$	ESD per IEC 61000-4-2 (Air) ESD per IEC 61000-4-2 (Contact)	$\pm 15$ $\pm 8$	kV
$P_{PP}$	Peak Pulse Power (8/20 $\mu$ s)	350	W
$T_{OPT}$	Operating Temperature	-55/+150	$^{\circ}$ C
$T_{STG}$	Storage Temperature	-55/+150	$^{\circ}$ C
$T_L$	Lead Soldering Temperature	260 (10 sec.)	$^{\circ}$ C

ELECTRICAL CHARACTERISTICS (Tamb=25 $^{\circ}$ C)									
PART NUMBER	DEVICE MARKING	$V_{RWM}$	$V_B$	$I_T$	$V_C@1A$	$V_C$		$I_R$	$C_T$
		(V) (max.)	(V) (min.)	(mA)	(V) (max.)	(max.) )	(@A)	( $\mu$ A) (max.) )	(pF) (max.)
SLPESD3V3L1BA	AB	3.3	4.0	1	7.5	13.0	20	40	450
SLPESD5V0L1BA	AC	5.0	6.0	1	9.8	18.0	17	10	200
SLPESD12VL1BA	AD	12.0	13.3	1	19.0	32.0	11	1	75
SLPESD15VL1BA	AE	15.0	16.7	1	24.0	38.0	10	1	68
SLPESD24VL1BA	AF	24.0	26.7	1	43.0	52.0	7	1	50

## ELECTRICAL CHARACTERISTICS CURVE

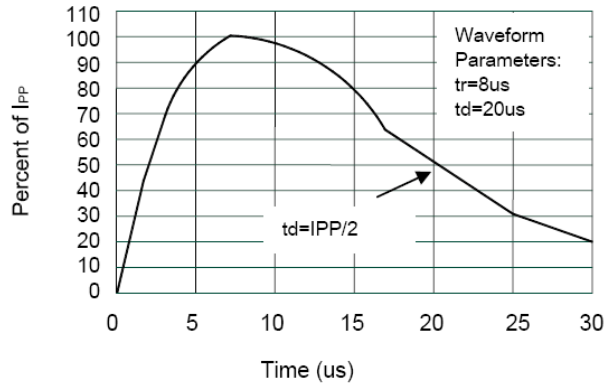

**Pulse Waveform**

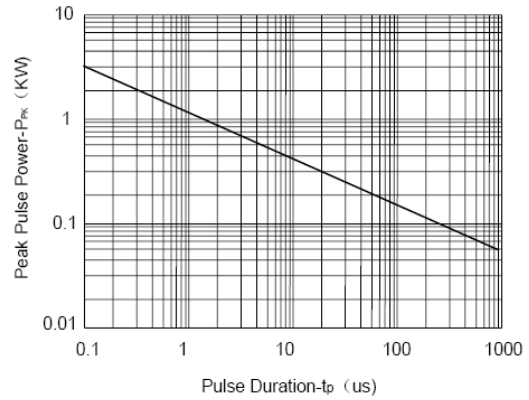

**Non-Repetitive Peak Pulse Power vs. Pulse Time**

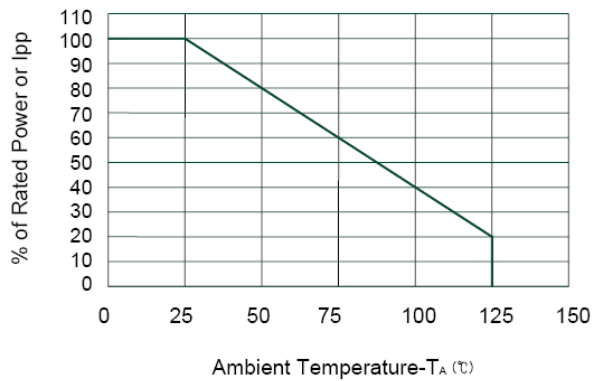

**Power Derating Curve**

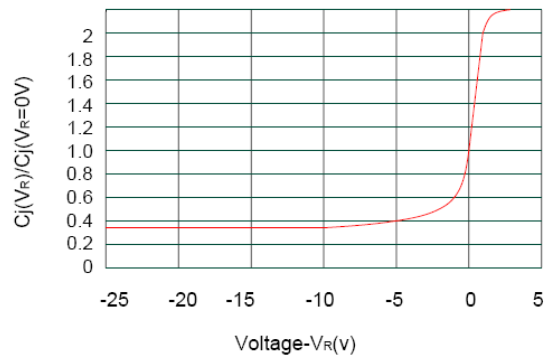

**Junction Capacitance vs. Reverse Voltage**

## SOD-323 PACKAGE OUTLINE DIMENSIONS

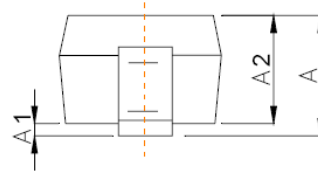
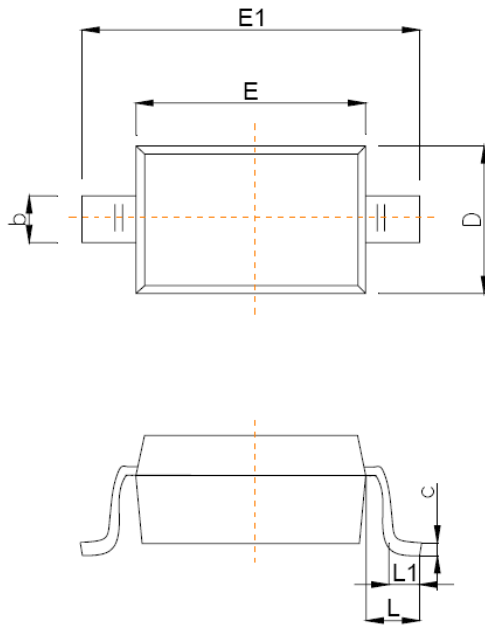

Symbol	Dimensions In Millimeters	
	Min	Max
A		1.00
A1	0.000	0.100
A2	0.800	0.900
b	0.250	0.350
c	0.080	0.150
D	1.200	1.400
E	1.600	1.800
E1	2.500	2.700
e	1.800	2.040
L	0.475 REF	
L1	0.250	0.400
$\theta$	0°	8°

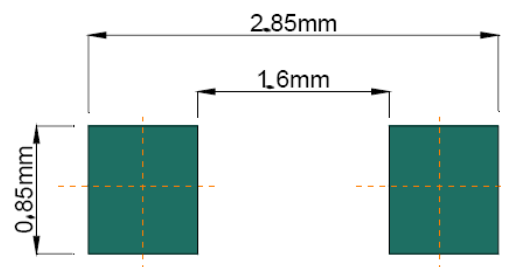

**Recommended Pad outline**

## X-ON Electronics

Largest Supplier of Electrical and Electronic Components

*Click to view similar products for [ESD Suppressors / TVS Diodes](#) category:*

*Click to view products by [SLKORMICRO](#) manufacturer:*

Other Similar products are found below :

[60KS200C](#) [D18V0L1B2LP-7B](#) [D5V0F4U5P5-7](#) [NTE4902](#) [P4KE27CA](#) [P6KE11CA](#) [P6KE8.2A](#) [SA60CA](#) [SA64CA](#) [SMBJ12CATR](#)  
[SMBJ33CATR](#) [SMBJ6.5A](#) [SMBJ8.0A](#) [ESD101-B1-02ELS E6327](#) [ESD112-B1-02EL E6327](#) [ESD7451N2T5G](#) [19180-510](#) [CPDT-5V0USP-](#)  
[HF](#) [3.0SMCJ33CA-F](#) [3.0SMCJ36A-F](#) [HSPC16701B02TP](#) [JANTX1N6126A](#) [D3V3Q1B2DLP3-7](#) [D55V0M1B2WS-7](#) [SCM1293A-04SO](#)  
[ESD200-B1-CSP0201 E6327](#) [SM12-7](#) [CEN955 W/DATA](#) [VESD12A1A-HD1-GS08](#) [CPDQC5V0-HF](#) [D1213A-01LP4-7B](#) [ESD101-B1-02EL](#)  
[E6327](#) [AOZ8808DI-03](#) [5KP15A](#) [5KP48A](#) [5KP90A](#) [ESD3V3D7-TP](#) [15KPA36A-LF](#) [P4KE56CA](#) [P4KE68A](#) [P4KE91CATR](#) [P6KE120A](#)  
[P6KE13CA](#) [P6KE43CA](#) [P6KE6.8CA](#) [P6KE8.2](#) [P6SMBJ20CA](#) [JANTX1N6072A](#) [SR2835ESKG](#) [SA90CA](#)