

High Voltage Hall Effect Switch Sensor

1. Introduction

SLSS360 Hall-Effect bipolar sensor, employed with high voltage bipolar technology, has been designed purposely for automotive and industrial applications, and operates with supply voltages from 3.8 V to 60 V in temperature range from -40 °C up to 150 °C. SLSS360 is available in SMD-package SOT23 and in the leaded version T092S.

2. Features

- Operates from 3.8 V to 60 V supply voltage
- Overvoltage protection capability up to 80 V
- Highest ESD performance up to $\pm 4\text{kV}$
- Short-circuit protected open-drain output
- Wide temperature range from -40 °C to 150 °C
- Ideal sensor for applications in extreme automotive and industrial environments
- Tiny SOT23 package and T092S package

3. Potential Applications

- Brushless DC motor commutation
- Speed measurement
- Revolution counting
- Angular position detection
- Proximity detection

4. Block Diagram

The circuit includes temperature compensated voltage regular, Hall plate, signal amplifier and hysteresis comparator in single silicon chip. The regulated voltage provides the reference voltage for the hall plate. A magnetic field perpendicular to the sensor surface generates a hall voltage, which is amplified and then sent to a hysteresis comparator.

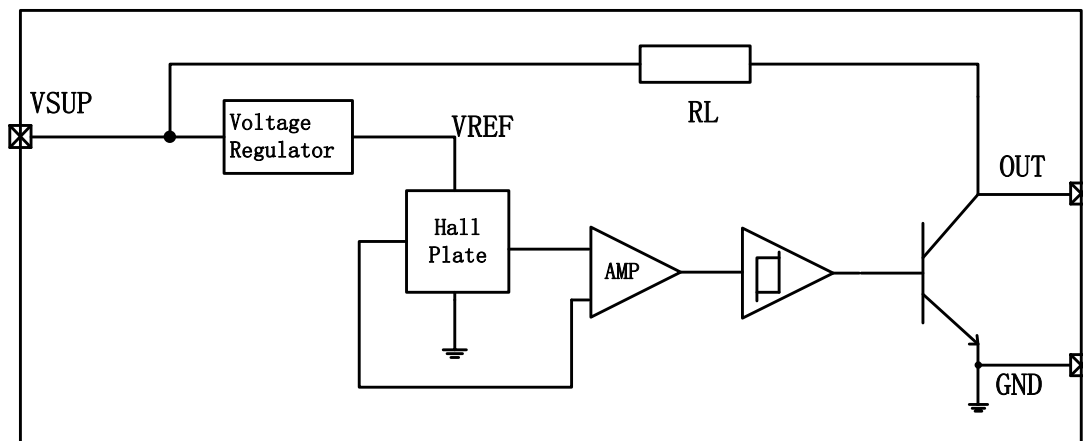

5. Pin Description

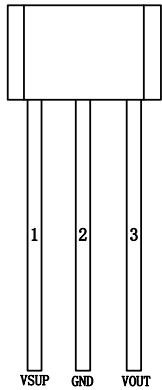
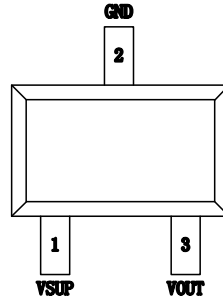
TO92S

SOT23

6. Ordering information

Partnumber	package	Packing	Ambient, T _A
SLSS360-9	TO92S	Bulk, 1000 pieces/bag	-40°C to 150°C
SLSS360-3	SOT23	Reel, 3000pieces/reel	-40°C to 150°C

7. Pin assignment

SOT23-3LPin number	TO92SPin number	Name	Function
1	1	VSUP	Power supply
2	2	GND	Ground
3	3	VOUT	Open collector with a internal pull-up resistor

8. Absolute Maximum Ratings

Parameters	Symbol	Min	Max	Units
Power supply Voltage	VSUP	-0.5	80	V
Output voltage	VOUT	-0.5	80	V
Output current sink	I _{sink}	0	40	mA
Operating ambient temperature	T _a	-40	150	°C
Storage temperature	T _{stg}	-50	165	°C

9. Electrical and magnetic characteristics(Ta=25°C)

Symbol	Parameter	Test conditions	Min.	Typ.	Max.	Units
Electrical characteristics						
VSUP	Supply voltage		3.8		60	V
ISUP	Supply current			4.8	8	mA
Ile	Leakage current	Off state			10	uA
Vsat	Output saturation voltage	On state			0.4	V
Tr	Output rise time	Rload=1kohms Cload=20pF			1	uS
Tf	Output fall time	Rload=1kohms Cload=20pF			1.5	uS
RL	Built-in pull-up resistor			10		Kohm
Magnetic characteristics						
Bop	Operate point	Rload=1kohms Cload=20pF	10	25	40	Gauss
Brp	Release point		-40	-25	-10	Gauss
Bhys	Hysteresis			50		Gauss

10.Magnetolectric conversion characteristics

Apply a magnetic field greater than Bop on the seal side of TO92S package (near the South Pole), and the output becomes low;Apply a magnetic field less than Brp (near the North Pole) and the output becomes high.When the chip is first powered on, if the magnetic field is between the Bop and the Brp, the output state is in an undefined state (high or low).The magnetic field polarity of the operating and releasing points of SOT23-3L package is opposite to that of TO92S.See below.

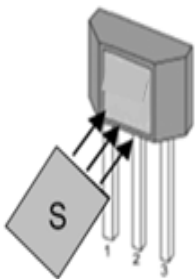
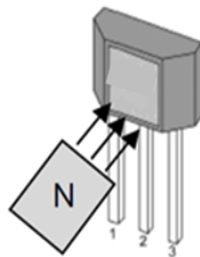
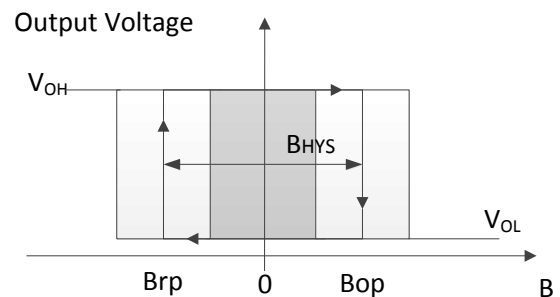
 $V_{OUT}=low$

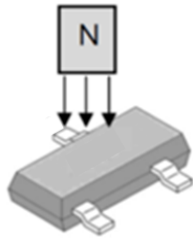
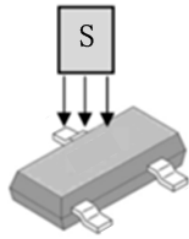
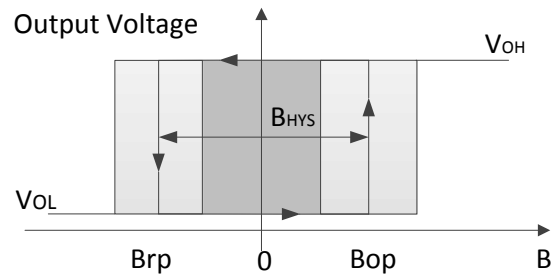
 $V_{OUT}=high$

TO92S output state

 $V_{OUT} = \text{low}$

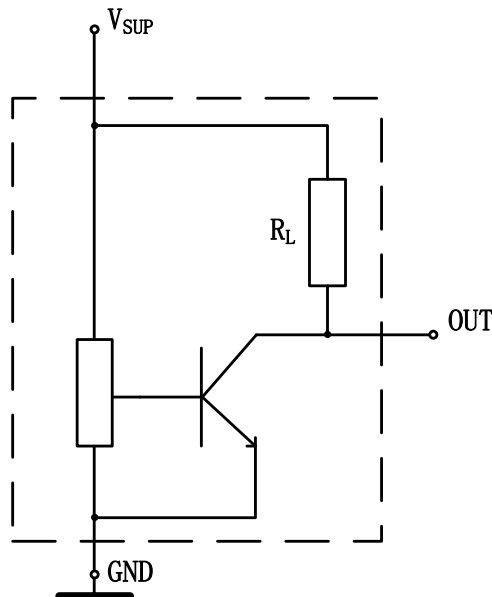
 $V_{OUT} = \text{high}$

SOT23-3L output state

11. Application Circuit

Typical application circuit (see Fig. below)



An example of typical application circuit

For applications with disturbances on the supply line or radiated disturbances, a series resistor R_V and two capacitors C_P and C_L all placed close to the sensor are recommended (see Fig. below).

For example: $R_V = 100$ ohms, $C_P = 4.7$ nF, and $C_L = 1$ nF.

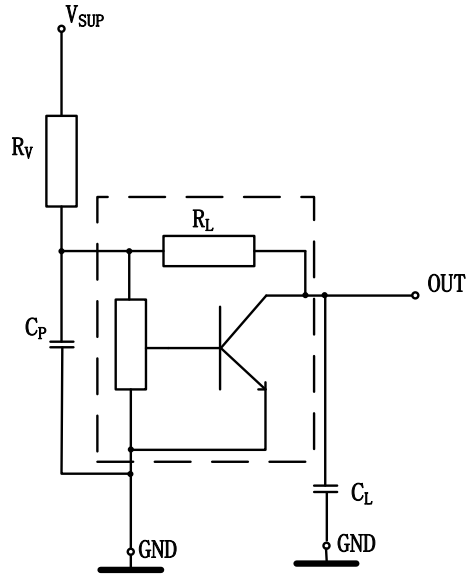

Example of application circuit 2

12. Outline dimensions

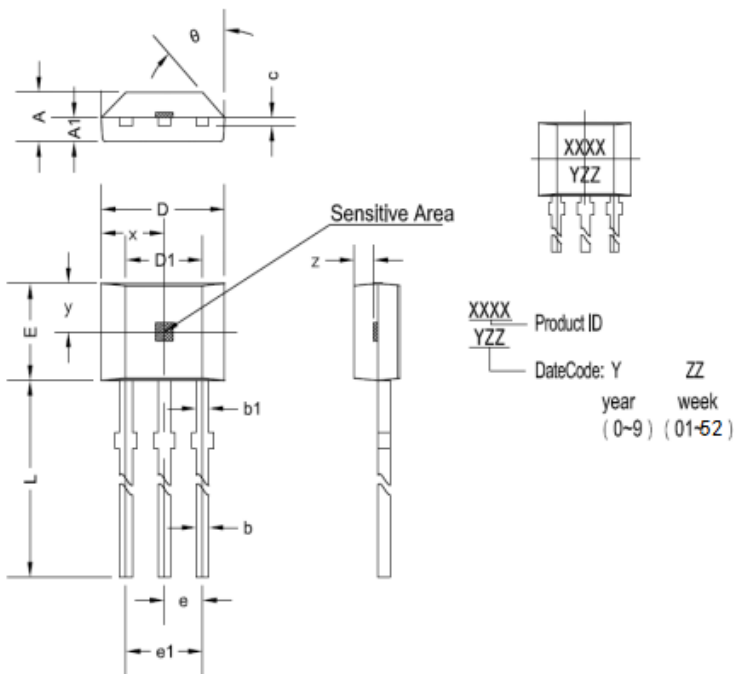

symbol	Size (mm)		Size (in inches)	
	minimum	maximum	minimum	maximum
A	1.42	1.67	0.056	0.066
A1	0.66	0.86	0.026	0.034
b	0.35	0.56	0.014	0.022
b1	0.4	0.55	0.016	0.022
C	0.36	0.51	0.014	0.02
D	3.9	4.2	0.154	0.165
D1	2.97	3.27	0.117	0.129
E	2.9	3.28	0.114	0.129
e	1.270 TYP		0.050 TYP	
e1	2.44	2.64	0.096	0.104
L	13.5	15.5	0.531	0.61
x	2.025TYP		0.080TYP	
y	1.545TYP		0.061TYP	
z	0.500TYP		0.020TYP	
θ	45°TYP		45°TYP	

SLSS360 package outline

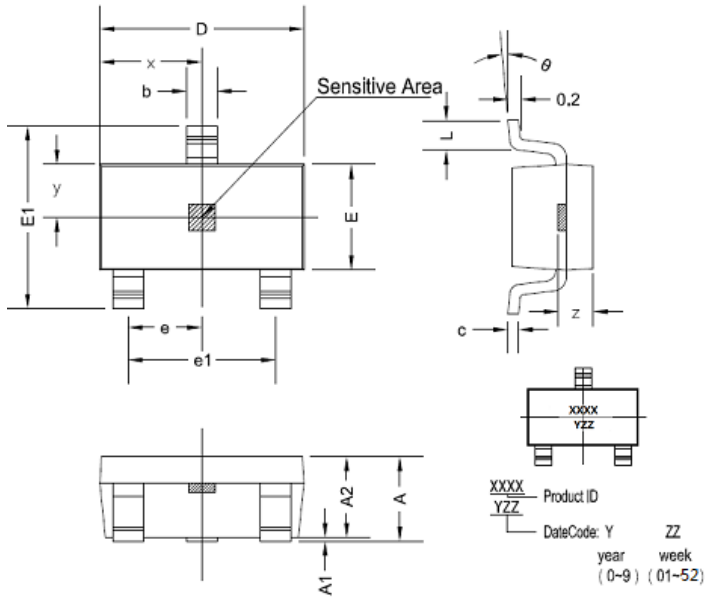

symbol	Size (mm)		Size (inches)	
	Min.	Max.	Min.	Max.
A	1.05	1.25	0.041	0.049
A1	0	0.1	0	0.004
A2	1.05	1.15	0.041	0.045
b	0.3	0.5	0.012	0.02
c	0.100	0.2	0.004	0.008
D	2.82	3.02	0.111	0.119
E	1.5	1.7	0.059	0.067
E1	2.65	2.95	0.104	0.116
e	0.950 TYP		0.037 TYP	
e1	1.8	2	0.071	0.079
L	0.3	0.6	0.012	0.024
x	1.460TYP		0.057TYP	
y	0.800TYP		0.032TYP	
z	0.600TYP		0.024TYP	
θ	0°	8°	0°	8°

X-ON Electronics

Largest Supplier of Electrical and Electronic Components

Click to view similar products for [Board Mount Hall Effect/Magnetic Sensors](#) category:

Click to view products by [SLKORMICRO](#) manufacturer:

Other Similar products are found below :

[HGPRDT005A](#) [AH277AZ4-AG1](#) [AV-10448](#) [HMC1041Z-TR](#) [SS41C](#) [TLE4917](#) [TLE4946-1L](#) [50017859-003](#) [TY-13101](#) [TLE4976L](#)
[SS85CA](#) [BU52002GUL-E2](#) [BU52003GUL-E2](#) [AH277AZ4-BG1](#) [TLE49614MXTSA1](#) [AH3376-P-B](#) [TLE4941](#) [AH211Z4-AG1](#) [AH3360-](#)
[FT4-7](#) [TLE4941-1](#) [AH374-P-A](#) [AH1913-W-7](#) [AH3373-P-B](#) [TLE9852QXXUMA1](#) [MA732GQ-Z](#) [MA330GQ-Z](#) [S-57K1NBL2A-M3T2U](#) [S-](#)
[57P1NBL9S-M3T4U](#) [S-576ZNL2B-L3T2U](#) [S-576ZNL2B-A6T8U](#) [S-57P1NBL0S-M3T4U](#) [S-57A1NSL1A-M3T2U](#) [S-57K1RBL1A-M3T2U](#)
[S-57P1NBH9S-M3T4U](#) [S-57P1NBH0S-M3T4U](#) [S-57A1NSH1A-M3T2U](#) [S-57A1NSH2A-M3T2U](#) [S-57K1NBH1A-M3T2U](#) [S-57A1NNL1A-](#)
[M3T2U](#) [S-5701BC10B-L3T2U5](#) [S-5701BC11B-L3T2U5](#) [S-57GNNL3S-A6T8U](#) [S-57TZ1L1S-A6T8U](#) [S-57GSNL3S-A6T8U](#) [S-](#)
[5716ANDH0-I4T1U](#) [S-57GSNL5S-L3T2U](#) [S-57GDNL3S-L3T2U](#) [S-57GNNL3S-L3T2U](#) [S-57RBNL8S-L3T2U](#) [S-57RBNL9S-A6T8U](#)