

The SMDJ series is designed specifically to protect sensitive electronic equipment from voltage transients induced by lightning and other transient voltage events.

### MECHANICAL DATA

- Case: SMC
- Terminals: Solderable per MIL-STD-750, Method 2026
- Approx. Weight: 0.22g / 0.0077oz

### FEATURES

- Halogen-Free
- RoHS compliant
- For surface mounted applications in order to optimize board space
- Low profile package
- Built-in strain relief
- Typical maximum temperature coefficient  $\Delta VBR = 0.1\% \times VBR@25^{\circ}C \times \Delta T$
- Glass passivated chip junction
- 3000W peak pulse power capability at IOxIOOOUs waveform, repetition rate {duty cycles}:0.01 %

### PINNING

PIN	DESCRIPTION
1	Cathode
2	Anode

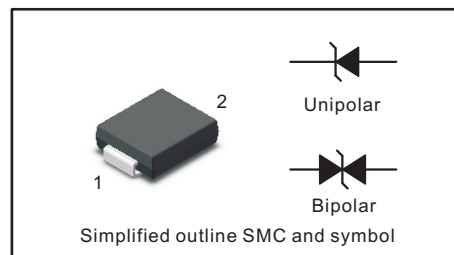

- Fast response time: typically less than I.Ops from OV to BV min
- Excellent clamping capability
- Low incremental surge resistance
- Typical IR less than 2UA above 12V
- High Temperature soldering guaranteed: 260°C/40 seconds at terminals
- Plastic package has Underwriters Laboratory Flammability 94V-O
- Matte Tin Lead-free Plated

### Maximum Ratings and Thermal Characteristics (TA=25°C unless otherwise noted)

Parameter	Symbol	Value	Unit
Peak Pulse Power Dissipation at T <sub>A</sub> =25°C by 10x1000 us waveform (Fig.1)(Note 1), (Note 2)	P <sub>PPM</sub>	3000	W
Power Dissipation on infinite heat sink at TA=50°C	P <sub>M(AV)</sub>	6.5	W
Peak Forward Surge Current, 8.3ms Single Half Sine Wave (Note 3)	I <sub>FSM</sub>	300	A
Maximum Instantaneous Forward Voltage at 100A for Unidirectional only	V <sub>F</sub>	3.5	V
Operating Junction and Storage Temperature Range	T <sub>J</sub> T <sub>STG</sub>	-65 to 150	°C
Typical Thermal Resistance Junction to Lead	R <sub>UJL</sub>	15	°C/W
Typical Thermal Resistance Junction to Ambient	R <sub>UJA</sub>	75	°C/W

#### Notes:

1. Non-repetitive current pulse . per Fig 3 and derated above Ta = 25°C per Fig. 2
2. Mounted on copper pad area of 0.31x0.31" (8.0 x 8.0mm) to each terminal
3. Measured on 8.3ms single half sine wave or equivalent square wave for unidirectional device only, duty cycle=4 per minute maximum

Characteristics at Ta = 25°C

Table 1

Type		Reverse Stand-off Voltage	Breakdown Voltage		Test Current	Max. Clamp Voltage	Max. Peak Pulse Current	Max. Reverse Leakage	Package	
			V <sub>BR</sub> @ I <sub>T</sub>						SMC	
			UNI	BI	V <sub>RMW</sub>	Min	Max	I <sub>T</sub>	V <sub>C</sub> @ I <sub>PP</sub>	I <sub>PP</sub>
		V	V	V	mA	V	A	uA	UNI	BI
SMDJ5.0A	SMDJ5.0CA	5.0	6.4	7	10	9.2	326.1	800	RDE	DDE
SMDJ6.0A	SMDJ6.0CA	6.0	6.67	7.37	10	10.3	291.3	800	RDG	DDG
SMDJ6.5A	SMDJ6.5CA	6.5	7.22	7.98	10	11.2	267.9	500	RDK	DDK
SMDJ7.0A	SMDJ7.0CA	7.0	7.78	8.6	10	12	250	200	PDM	DDM
SMDJ7.5A	SMDJ7.5CA	7.5	8.33	9.21	1	12.9	232.6	100	PDP	DDP
SMDJ8.0A	SMDJ8.0CA	8.0	8.89	9.83	1	13.6	220.6	50	PDR	DDR
SMDJ8.5A	SMDJ8.5CA	8.5	9.44	10.4	1	14.4	208.3	20	PDT	DDT
SMDJ9.0A	SMDJ9.0CA	9.0	10	11.1	1	15.4	194.8	10	PDV	DDV
SMDJ10A	SMDJ10CA	10.0	11.1	12.3	1	17	176.5	5	PDX	DDX
SMDJ11A	SMDJ11CA	11.0	12.2	13.5	1	18.2	164.8	2	PDZ	DDZ
SMDJ12A	SMDJ12CA	12.0	13.3	14.7	1	19.9	150.8	2	PEE	DEE
SMDJ13A	SMDJ13CA	13.0	14.4	15.9	1	21.5	139.5	2	PEG	DEG
SMDJ14A	SMDJ14CA	14.0	15.6	17.2	1	23.2	129.3	2	PEK	DEK
SMDJ15A	SMDJ15CA	15.0	16.7	18.5	1	24.4	123	2	PEM	DEM
SMDJ16A	SMDJ16CA	16.0	17.8	19.7	1	26	115.4	2	PEP	DEP
SMDJ17A	SMDJ17CA	17.0	18.9	20.9	1	27.6	108.7	2	PER	DER
SMDJ18A	SMDJ18CA	18.0	20	22.1	1	29.2	102.7	2	PET	DET
SMDJ20A	SMDJ20CA	20.0	22.2	24.5	1	32.4	92.6	2	PEV	DEV
SMDJ22A	SMDJ22CA	22.0	24.4	26.9	1	35.5	84.5	2	PEX	DEX
SMDJ24A	SMDJ24CA	24.0	26.7	29.5	1	38.9	77.1	2	PEZ	DEZ
SMDJ26A	SMDJ26CA	26.0	28.9	31.9	1	42.1	71.3	2	PFE	DFE
SMDJ28A	SMDJ28CA	28.0	31.1	34.4	1	45.4	66.1	2	PFG	DFG
SMDJ30A	SMDJ30CA	30.0	33.3	36.8	1	48.4	62	2	PFK	DFK
SMDJ33A	SMDJ33CA	33.0	36.7	40.6	1	53.3	56.3	2	PFM	DFM
SMDJ36A	SMDJ36CA	36.0	40	44.2	1	58.1	51.6	2	PFP	DFP
SMDJ40A	SMDJ40CA	40.0	44.4	49.1	1	64.5	46.5	2	PFR	DFR
SMDJ43A	SMDJ43CA	43.0	47.8	52.8	1	69.4	43.2	2	PFT	DFT
SMDJ45A	SMDJ45CA	45.0	50	55.3	1	72.7	41.3	2	PFV	DFV
SMDJ48A	SMDJ48CA	48.0	53.3	58.9	1	77.4	38.8	2	PFX	DFX
SMDJ51A	SMDJ51CA	51.0	56.7	62.7	1	82.4	36.4	2	PFZ	DFZ
SMDJ54A	SMDJ54CA	54.0	60	66.3	1	87.1	34.4	2	RGE	DGE
SMDJ58A	SMDJ58CA	58.0	64.4	71.2	1	93.6	32.1	2	PGG	DGG
SMDJ60A	SMDJ60CA	60.0	66.7	73.7	1	96.8	31	2	PGK	DGK
SMDJ64A	SMDJ64CA	64.0	71.1	78.6	1	103	29.1	2	PGM	DGM
SMDJ70A	SMDJ70CA	70.0	77.8	86	1	113	26.5	2	PGP	DGP
SMDJ75A	SMDJ75CA	75.0	83.3	92.1	1	121	24.8	2	PGR	DGR
SMDJ78A	SMDJ78CA	78.0	86.7	95.8	1	126	23.8	2	PGT	DGT
SMDJ85A	SMDJ85CA	85.0	94.4	104	1	137	21.9	2	PGV	DGV
SMDJ90A	SMDJ90CA	90.0	100	111	1	146	20.5	2	PGX	DGX
SMDJ100A	SMDJ100CA	100.0	111	123	1	162	18.5	2	PGZ	DGZ
SMDJ110A	SMDJ110CA	110.0	122	135	1	177	16.9	2	PHE	DHE
SMDJ120A	SMDJ120CA	120.0	133	147	1	193	15.5	2	PHG	DHG
SMDJ130A	SMDJ130CA	130.0	144	159	1	209	14.4	2	PHK	DHK
SMDJ150A	SMDJ150CA	150.0	167	185	1	243	12.3	2	PHM	DHM
SMDJ160A	SMDJ160CA	160.0	178	197	1	259	11.6	2	PHP	DHP
SMDJ170A	SMDJ170CA	170.0	189	209	1	275	10.9	2	PHR	DHR

**Fig.1 Peak Pulse Power Rating Curve**

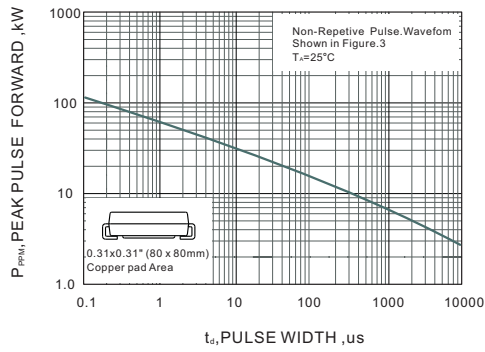

**Fig.2 Forward Current Derating Curve**

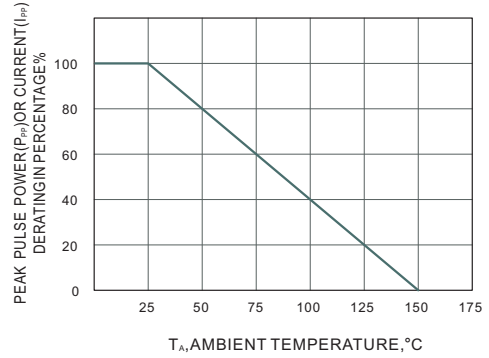

**Fig.3 Pulse Waveform**

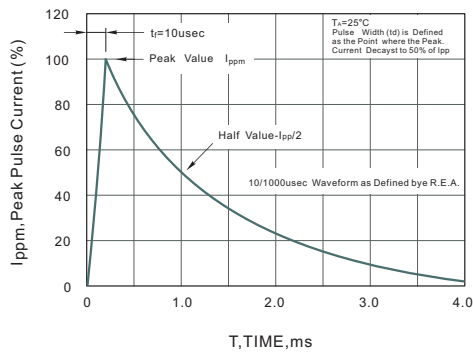

**Fig.4 Typical Junction Capacitance**

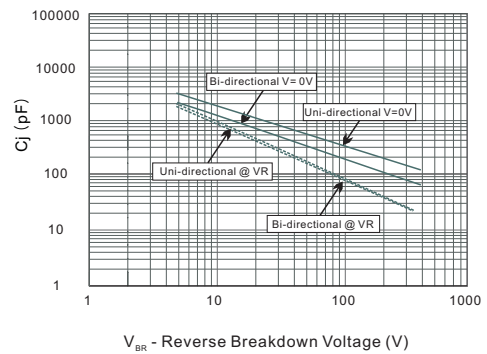

**Fig.5 Steady State Power Derating Curve**

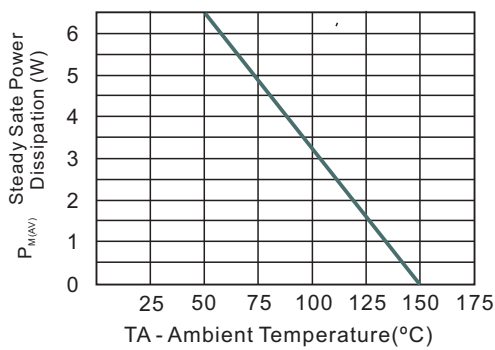

**Fig.6 Maximum Non-Repetitive Peak Forward Surge Current**

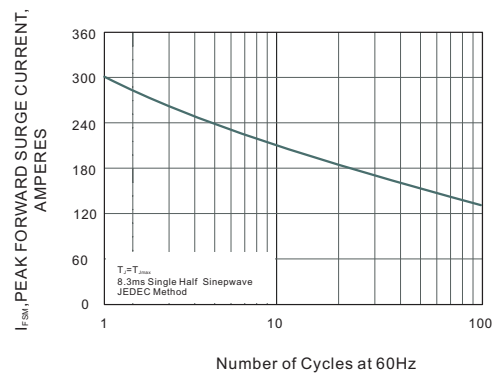



## X-ON Electronics

Largest Supplier of Electrical and Electronic Components

*Click to view similar products for [ESD Suppressors / TVS Diodes](#) category:*

*Click to view products by [SLKORMICRO](#) manufacturer:*

Other Similar products are found below :

[60KS200C](#) [D18V0L1B2LP-7B](#) [D5V0F4U5P5-7](#) [NTE4902](#) [P4KE27CA](#) [P6KE11CA](#) [P6KE8.2A](#) [SA60CA](#) [SA64CA](#) [SMBJ12CATR](#)  
[SMBJ33CATR](#) [SMBJ6.5A](#) [SMBJ8.0A](#) [ESD101-B1-02ELS E6327](#) [ESD112-B1-02EL E6327](#) [ESD7451N2T5G](#) [19180-510](#) [CPDT-5V0USP-](#)  
[HF](#) [3.0SMCJ33CA-F](#) [3.0SMCJ36A-F](#) [HSPC16701B02TP](#) [JANTX1N6126A](#) [D3V3Q1B2DLP3-7](#) [D55V0M1B2WS-7](#) [SCM1293A-04SO](#)  
[ESD200-B1-CSP0201 E6327](#) [SM12-7](#) [CEN955 W/DATA](#) [VESD12A1A-HD1-GS08](#) [CPDQC5V0-HF](#) [D1213A-01LP4-7B](#) [ESD101-B1-02EL](#)  
[E6327](#) [AOZ8808DI-03](#) [5KP15A](#) [5KP48A](#) [5KP90A](#) [ESD3V3D7-TP](#) [15KPA36A-LF](#) [P4KE56CA](#) [P4KE68A](#) [P4KE91CATR](#) [P6KE120A](#)  
[P6KE13CA](#) [P6KE43CA](#) [P6KE6.8CA](#) [P6KE8.2](#) [P6SMBJ20CA](#) [JANTX1N6072A](#) [SR2835ESKG](#) [SA90CA](#)