

**Surface Mount Schottky Barrier Rectifier**  
**Reverse Voltage - 20 to 200 V**  
**Forward Current - 2.0A**

**Features**

- Metal silicon junction, majority carrier conduction
- For surface mounted applications
- Low power loss, high efficiency
- High forward surge current capability
- For use in low voltage, high frequency inverters, free wheeling, and polarity protection applications

**MECHANICAL DATA**

- Case: SMAF
- Terminals: Solderable per MIL-STD-750, Method 2026
- Approx. Weight: 27mg / 0.00095oz

**PINNING**

PIN	DESCRIPTION
1	Cathode
2	Anode

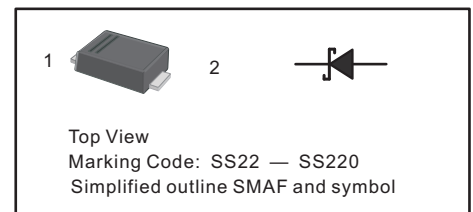

**Absolute Maximum Ratings and Electrical characteristics**

Ratings at 25 °C ambient temperature unless otherwise specified. Single phase, half wave, 60Hz resistive or inductive load, for capacitive load, derate by 20 %

Parameter	Symbols	SS22F	SS24F	SS26F	SS28F	SS210F	SS212F	SS215F	SS220F	Units
Maximum Repetitive Peak Reverse Voltage	$V_{RRM}$	20	40	60	80	100	120	150	200	V
Maximum RMS voltage	$V_{RMS}$	14	28	42	56	70	84	105	140	V
Maximum DC Blocking Voltage	$V_{DC}$	20	40	60	80	100	120	150	200	V
Maximum Average Forward Rectified Current	$I_{F(AV)}$	2.0								A
Peak Forward Surge Current, 8.3ms Single Half Sine-wave Superimposed on Rated Load (JEDEC method)	$I_{FSM}$	50								A
Max Instantaneous Forward Voltage at 2 A	$V_F$	0.55	0.70		0.85		0.95		V	
Maximum DC Reverse Current $T_a = 25^\circ\text{C}$ at Rated DC Reverse Voltage $T_a = 100^\circ\text{C}$	$I_R$	0.5 5			0.3 3				mA	
Typical Junction Capacitance <sup>(1)</sup>	$C_j$	160	80						pF	
Typical Thermal Resistance <sup>(2)</sup>	$R_{\theta JA}$	80								°C/W
Operating Junction Temperature Range	$T_j$	-55 ~ +125								°C
Storage Temperature Range	$T_{stg}$	-55 ~ +150								°C

( 1 ) Measured at 1 MHz and applied reverse voltage of 4 V D.C

( 2 ) P.C.B. mounted with 2.0" X 2.0" (5 X 5 cm) copper pad areas.

**Fig.1 Forward Current Derating Curve**

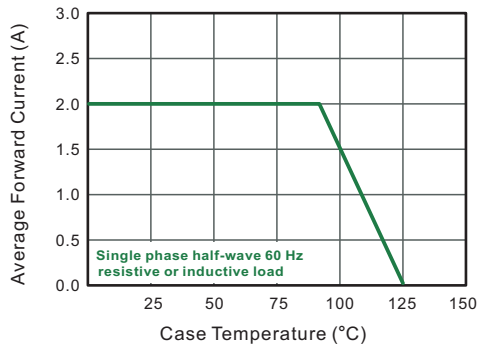

**Fig.2 Typical Reverse Characteristics**

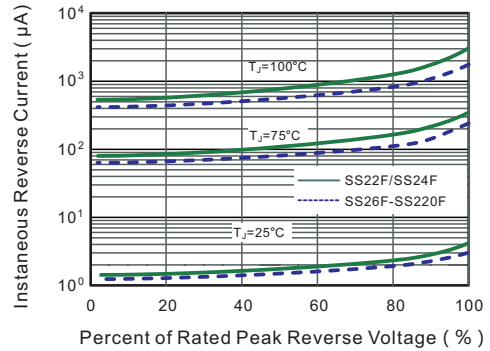

**Fig.3 Typical Forward Characteristic**

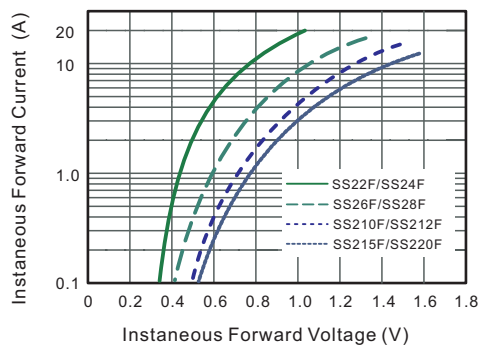

**Fig.4 Typical Junction Capacitance**

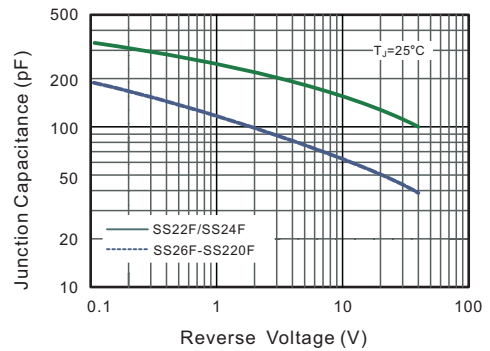

**Fig.5 Maximum Non-Repetitive Peak Forward Surge Current**

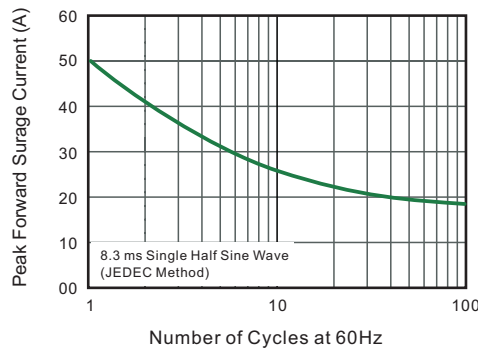

**Fig.6- Typical Transient Thermal Impedance**

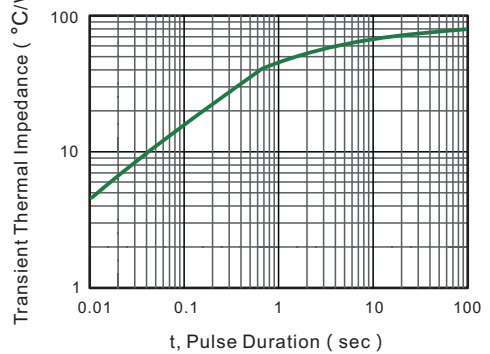

## PACKAGE OUTLINE

Plastic surface mounted package; 2 leads

SMAF

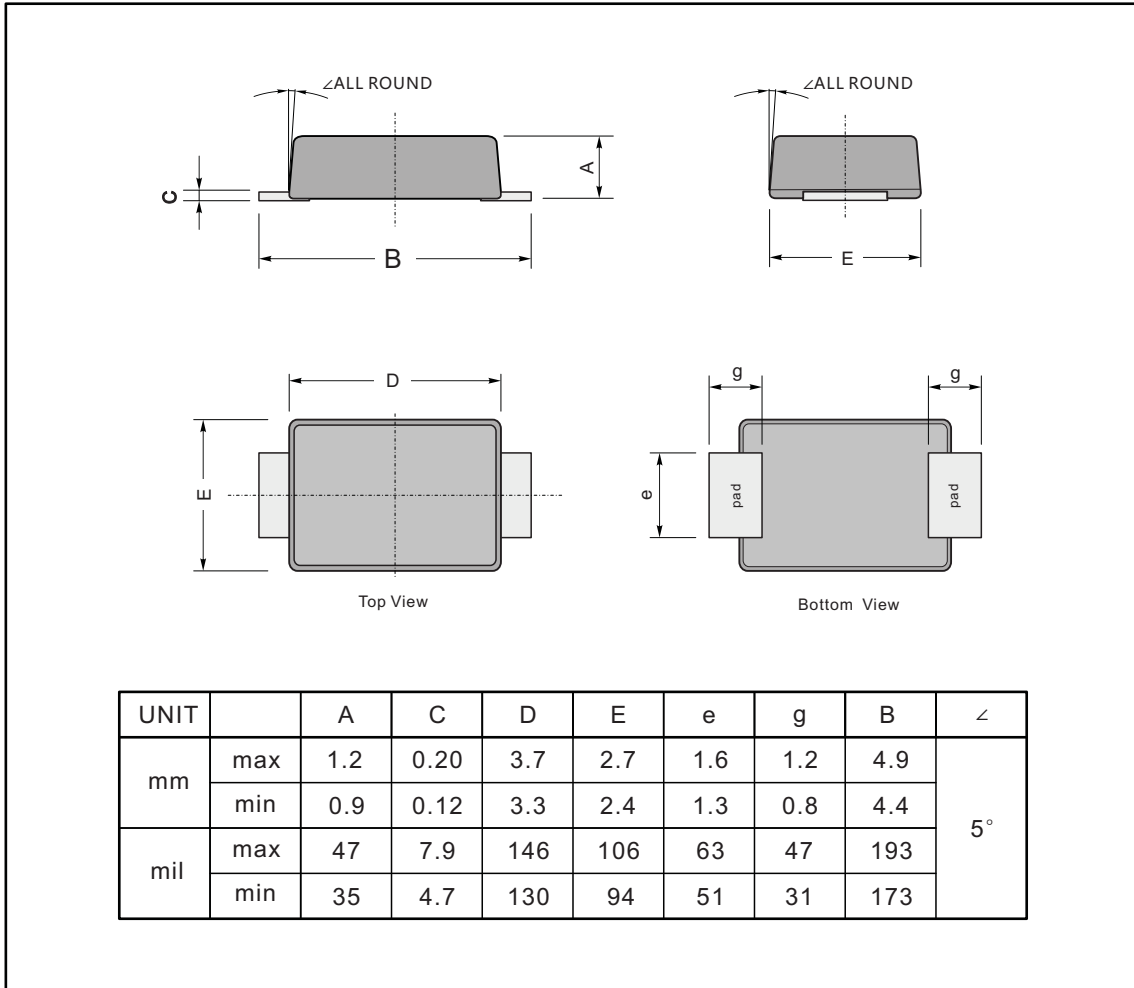

### The recommended mounting pad size

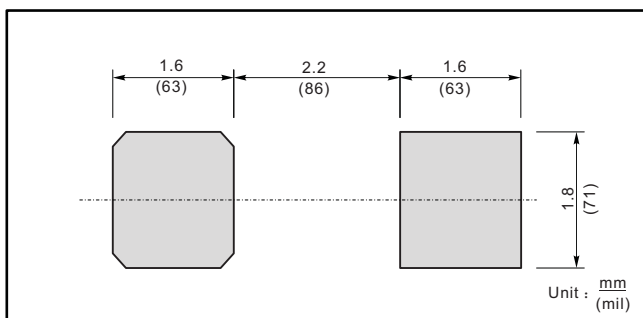

### Marking

Type number	Marking code
SS22F	SS22
SS24F	SS24
SS26F	SS26
SS28F	SS28
SS210F	SS210
SS212F	SS212
SS215F	SS215
SS220F	SS220

## X-ON Electronics

Largest Supplier of Electrical and Electronic Components

*Click to view similar products for [Schottky Diodes & Rectifiers](#) category:*

*Click to view products by [SLKORMICRO](#) manufacturer:*

Other Similar products are found below :

[MA4E2039](#) [MA4E2508M-1112](#) [MBR1545CT](#) [MMBD301M3T5G](#) [RB160M-50TR](#) [D83C](#) [BAS16E6433HTMA1](#) [BAT 54-02LRH E6327](#)  
[NRVBAF360T3G](#) [NSR05F40QNXT5G](#) [NTE555](#) [JANS1N6640](#) [SK310-T](#) [SK34B-TP](#) [SS3003CH-TL-E](#) [GA01SHT18](#)  
[CRS10I30A\(TE85L,QM](#) [MA4E2501L-1290](#) [MBRA140TRPBF](#) [MBRB30H30CT-1G](#) [BAT 15-04R E6152](#) [JANTX1N5712-1](#) [DMJ3940-000](#)  
[SB007-03C-TB-E](#) [SK33B-TP](#) [NRVBB20100CTT4G](#) [NRVBM120LT1G](#) [NTSB30U100CT-1G](#) [VS-6CWQ10FNHM3](#) [CRG04\(T5L,TEMQ\)](#)  
[ACDBA1100LR-HF](#) [ACDBA1200-HF](#) [ACDBA240-HF](#) [ACDBA3100-HF](#) [CDBQC0530L-HF](#) [CDBQC0240LR-HF](#) [ACDBA260LR-HF](#)  
[ACDBA1100-HF](#) [MA4E2502L-1246](#) [10BQ015-M3/5BT](#) [NRVBM120ET1G](#) [CRS08TE85LQM](#) [PMAD1108-LF](#) [B120Q-13-F](#) [1N5819T-G](#)  
[B0530WSQ-7-F](#) [PDS1040Q-13](#) [B160BQ-13-F](#) [SDM05U20CSP-7](#) [B140S1F-7](#)