

## TRANSISTOR(PNP)

### FEATURES

- High Collector Current
- Complementary to SS8050

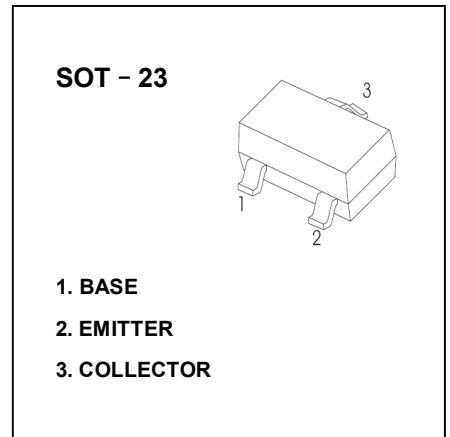

### MAXIMUM RATINGS ( $T_a=25^{\circ}\text{C}$ unless otherwise noted)

Symbol	Parameter	Value	Unit
$V_{CBO}$	Collector-Base Voltage	-40	V
$V_{CEO}$	Collector-Emitter Voltage	-25	V
$V_{EBO}$	Emitter-Base Voltage	-5	V
$I_C$	Collector Current	-1.5	A
$P_C$	Collector Power Dissipation	300	mW
$R_{\theta JA}$	Thermal Resistance From Junction To Ambient	417	$^{\circ}\text{C}/\text{W}$
$T_j$	Junction Temperature	150	$^{\circ}\text{C}$
$T_{stg}$	Storage Temperature	-55~+150	$^{\circ}\text{C}$

### ELECTRICAL CHARACTERISTICS ( $T_a=25^{\circ}\text{C}$ unless otherwise specified)

Parameter	Symbol	Test conditions	Min	Typ	Max	Unit
Collector-base breakdown voltage	$V_{(BR)CBO}$	$I_C=-100\mu\text{A}, I_E=0$	-40			V
Collector-emitter breakdown voltage	$V_{(BR)CEO}$	$I_C=-0.1\text{mA}, I_B=0$	-25			V
Emitter-base breakdown voltage	$V_{(BR)EBO}$	$I_E=-100\mu\text{A}, I_C=0$	-5			V
Collector cut-off current	$I_{CBO}$	$V_{CB}=-40\text{V}, I_E=0$			-100	nA
Collector cut-off current	$I_{CEO}$	$V_{CE}=-20\text{V}, I_B=0$			-100	nA
Emitter cut-off current	$I_{EBO}$	$V_{EB}=-5\text{V}, I_C=0$			-100	nA
DC current gain	$h_{FE(1)}$	$V_{CE}=-1\text{V}, I_C=-100\text{mA}$	120		400	
	$h_{FE(2)}$	$V_{CE}=-1\text{V}, I_C=-800\text{mA}$	40			
Collector-emitter saturation voltage	$V_{CE(sat)}$	$I_C=-800\text{mA}, I_B=-80\text{mA}$			-0.5	V
Base-emitter saturation voltage	$V_{BE(sat)}$	$I_C=-800\text{mA}, I_B=-80\text{mA}$			-1.2	V
Base-emitter voltage	$V_{BE}$	$V_{CE}=-1\text{V}, I_C=-10\text{mA}$			-1	V
Transition frequency	$f_T$	$V_{CE}=-10\text{V}, I_C=-50\text{mA}, f=30\text{MHz}$	100			MHz
Collector output capacitance	$C_{ob}$	$V_{CB}=-10\text{V}, I_E=0, f=1\text{MHz}$			20	pF

### CLASSIFICATION OF $h_{FE(1)}$

RANK	L	H	J
RANGE	120 - 200	200 - 350	300 - 400

**Static Characteristic**

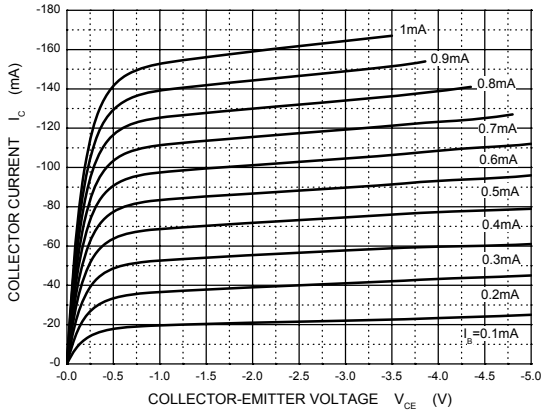

**$h_{FE} - I_c$**

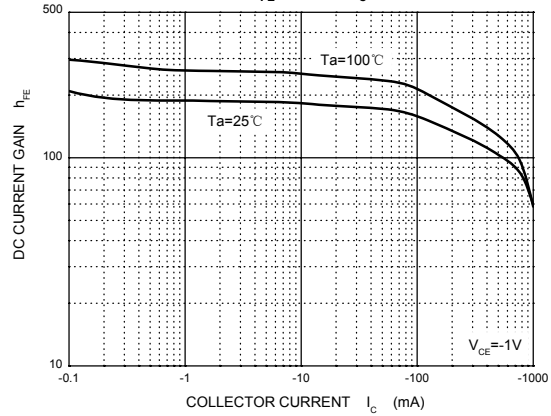

**$V_{BEsat} - I_c$**

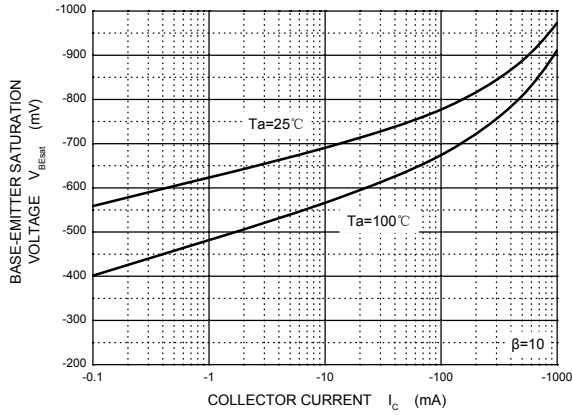

**$V_{CEsat} - I_c$**

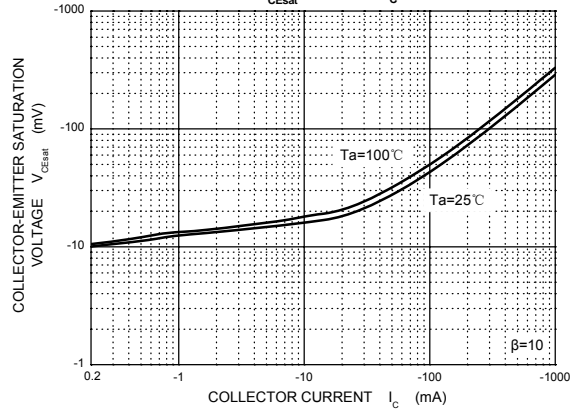

**$V_{BE} - I_c$**

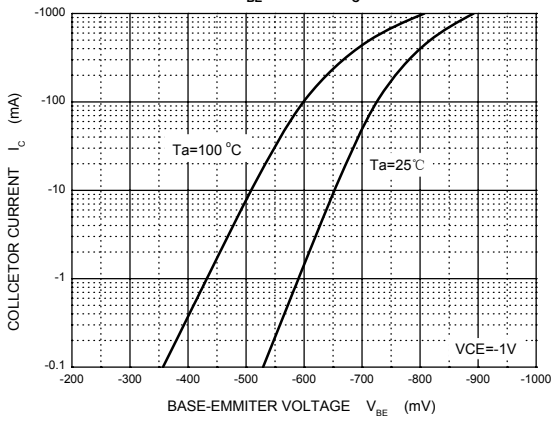

**$C_{ob}/C_{ib} - V_{CB}/V_{EB}$**

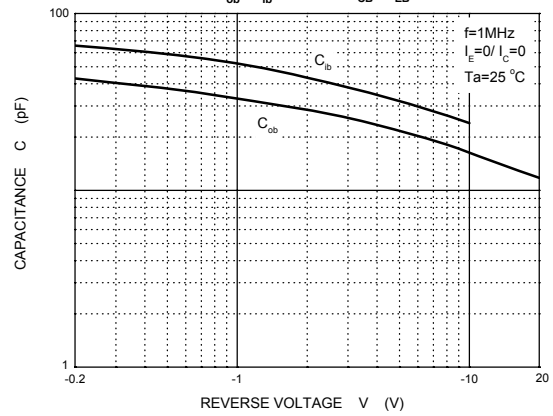

**$f_T - I_c$**

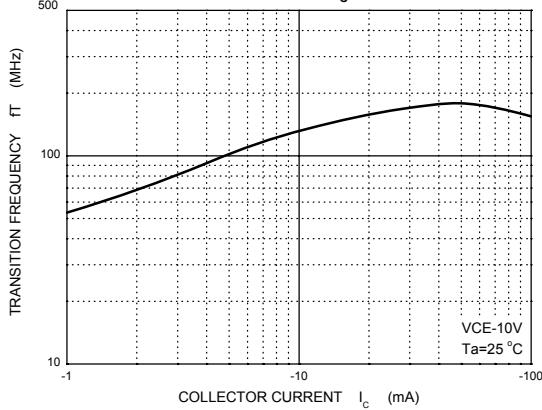

**$P_c - T_a$**

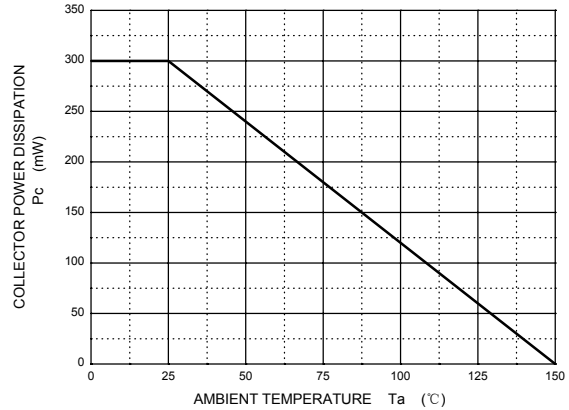

## X-ON Electronics

Largest Supplier of Electrical and Electronic Components

*Click to view similar products for [Bipolar Transistors - BJT category](#):*

*Click to view products by [SLKORMICRO manufacturer](#):*

Other Similar products are found below :

[619691C](#) [MCH4017-TL-H](#) [MJ15024/WS](#) [MJ15025/WS](#) [BC546/116](#) [BC556/FSC](#) [BC557/116](#) [BSW67A](#) [HN7G01FU-A\(T5L,F,T](#)  
[NJVMJD148T4G](#) [NSVMMBT6520LT1G](#) [NTE187A](#) [NTE195A](#) [NTE2302](#) [NTE2330](#) [NTE2353](#) [NTE316](#) [IMX9T110](#) [NTE63](#) [NTE65](#)  
[C4460](#) [SBC846BLT3G](#) [2SA1419T-TD-H](#) [2SA1721-O\(TE85L,F\)](#) [2SA1727TLP](#) [2SA2126-E](#) [2SB1202T-TL-E](#) [2SB1204S-TL-E](#) [2SC5488A-](#)  
[TL-H](#) [2SD2150T100R](#) [SP000011176](#) [FMC5AT148](#) [2N2369ADCSM](#) [2SB1202S-TL-E](#) [2SC2412KT146S](#) [2SC4618TLN](#) [2SC5490A-TL-H](#)  
[2SD1816S-TL-E](#) [2SD1816T-TL-E](#) [CMXT2207 TR](#) [CPH6501-TL-E](#) [MCH4021-TL-E](#) [BC557B](#) [TTC012\(Q\)](#) [BULD128DT4](#) [JANTX2N3810](#)  
[Jantx2N5416](#) [US6T6TR](#) [KSF350](#) [068071B](#)