

Schottky Barrier Diode

APPLICATIONS

- Rectification
- Protection against reverse connection of battery

FEATURES

- Forward Voltage : $V_F=0.49V$ (TYP.)
- Forward Current : $I_{F(AV)}=1A$
- Repetitive Peak Reverse Voltage : $V_{RM}=40V$

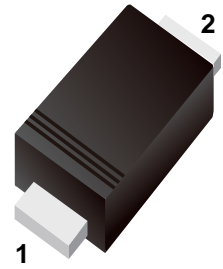

Simplified outline(SOD-123FL)

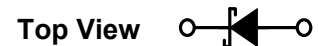

ABSOLUTE MAXIMUM RATINGS Ta=25°C

PARAMETER	SYMBOL	RATINGS	UNIT
Repetitive Peak Reverse Voltage	V_{RM}	40	V
Reverse Voltage (DC)	V_R	40	V
Forward Current (Average)	$I_{F(AV)}$	1	A
Non Continuous Forward Surge Current *1	I_{FSM}	10	A
Junction Temperature	T_J	125	
Storage Temperature Range	T_{stg}	-55 ~ +150	

*1 : Non continuous high amplitude 60Hz half-sine wave.

ELECTRICAL CHARACTERISTICS Ta=25

PARAMETER	SYMBOL	TEST CONDITIONS	LIMITS			UNIT
			MIN.	TYP.	MAX.	
Forward Voltage	V_{F1}	$I_F=100mA$	-	0.34	-	V
	V_{F2}	$I_F=1A$	-	0.49	0.54	V
Reverse Current	I_R	$V_R=40V$	-	4	200	μA
Inter-Terminal Capacity	C_t	$V_R=10V$, $f=1MHz$	-	35	-	pF
Reverse Recovery Time *2	t_{rr}	$I_F=I_R=10mA$, $i_{rr}=1mA$, $R_L=100$	-	25	-	ns

*2 : t_{rr} measurement circuit

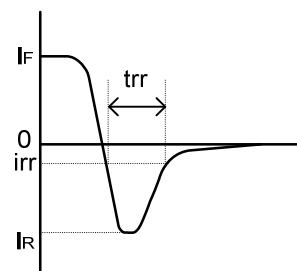
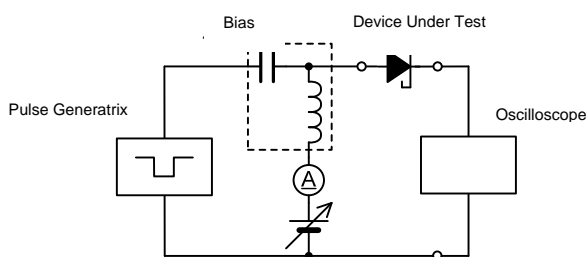

■ TYPICAL PERFORMANCE CHARACTERISTICS

(1) Forward Current vs. Forward Voltage

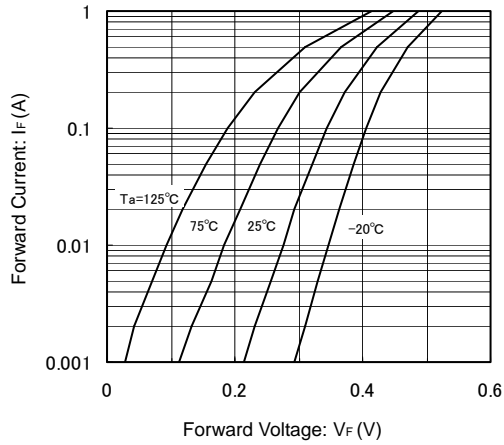

(2) Reverse Current vs. Reverse Voltage

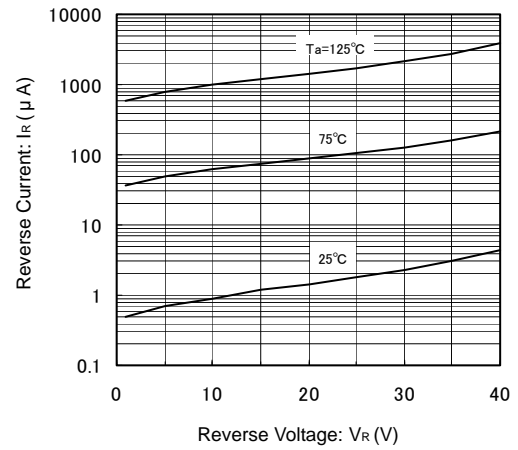

(3) Forward Voltage vs. Operating Temperature

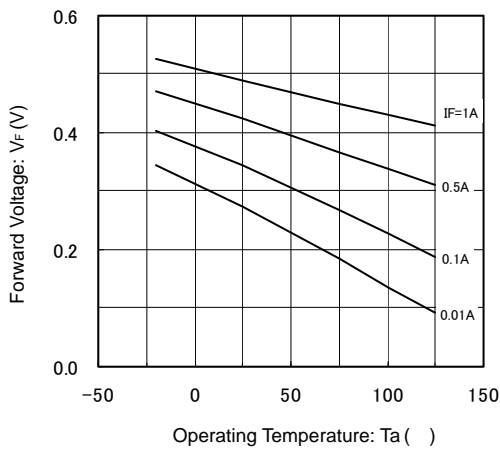

(4) Reverse Current vs. Operating Temperature

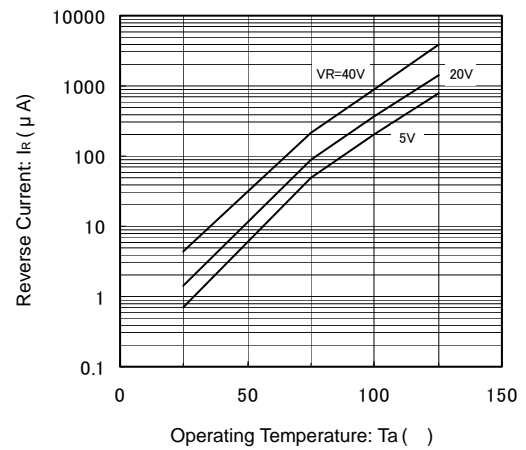

(5) Inter-Terminal Capacity vs. Reverse Voltage

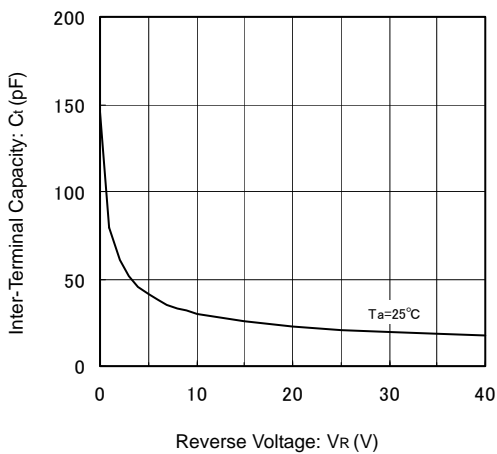

(6) Average Forward Current vs. Operating Temperature

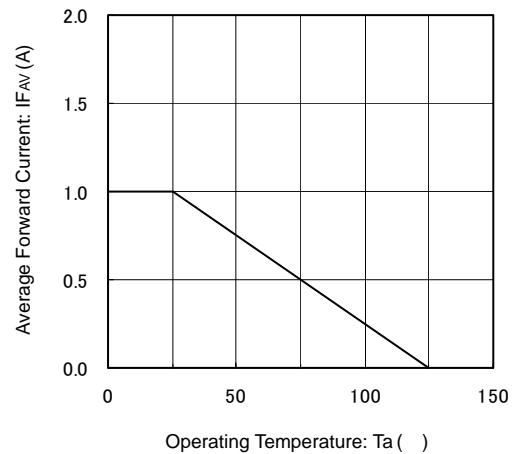

■ SOD-123FL

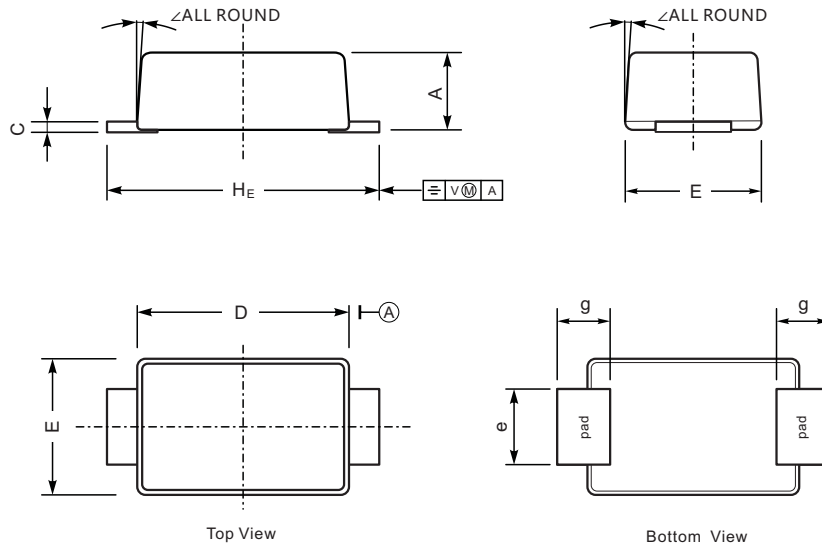

UNIT		A	C	D	E	e	g	H_E	\angle
mm	max	1.1	0.20	2.9	1.9	1.1	0.9	3.8	7°
	min	0.9	0.12	2.6	1.7	0.8	0.7	3.5	
mil	max	43	7.9	114	75	43	35	150	
	min	35	4.7	102	67	31	28	138	

■ The recommended mounting pad size

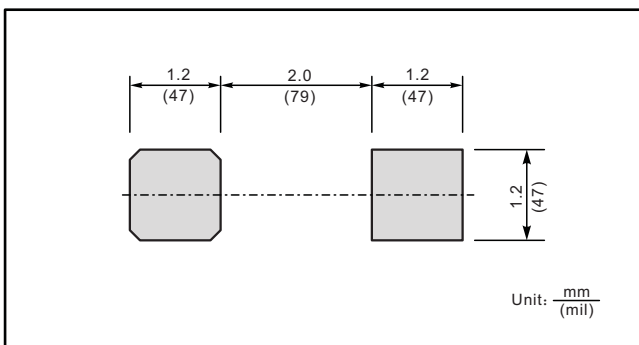

X-ON Electronics

Largest Supplier of Electrical and Electronic Components

Click to view similar products for [Schottky Diodes & Rectifiers](#) category:

Click to view products by [SLKORMICRO](#) manufacturer:

Other Similar products are found below :

[MA4E2039](#) [MA4E2508M-1112](#) [MBR1545CT](#) [MMBD301M3T5G](#) [RB160M-50TR](#) [D83C](#) [BAS16E6433HTMA1](#) [BAT 54-02LRH E6327](#)
[NRVBAF360T3G](#) [NSR05F40QNXT5G](#) [NTE555](#) [JANS1N6640](#) [SK310-T](#) [SK34B-TP](#) [SS3003CH-TL-E](#) [GA01SHT18](#)
[CRS10I30A\(TE85L,QM](#) [MA4E2501L-1290](#) [MBRA140TRPBF](#) [MBRB30H30CT-1G](#) [BAT 15-04R E6152](#) [JANTX1N5712-1](#) [DMJ3940-000](#)
[SB007-03C-TB-E](#) [SK33B-TP](#) [NRVBB20100CTT4G](#) [NRVBM120LT1G](#) [NTSB30U100CT-1G](#) [VS-6CWQ10FNHM3](#) [CRG04\(T5L,TEMQ\)](#)
[ACDBA1100LR-HF](#) [ACDBA1200-HF](#) [ACDBA240-HF](#) [ACDBA3100-HF](#) [CDBQC0530L-HF](#) [CDBQC0240LR-HF](#) [ACDBA260LR-HF](#)
[ACDBA1100-HF](#) [MA4E2502L-1246](#) [10BQ015-M3/5BT](#) [NRVBM120ET1G](#) [CRS08TE85LQM](#) [PMAD1108-LF](#) [B120Q-13-F](#) [1N5819T-G](#)
[B0530WSQ-7-F](#) [PDS1040Q-13](#) [B160BQ-13-F](#) [SDM05U20CSP-7](#) [B140S1F-7](#)