

Industrial

FEATURES AND BENEFITS

175W W/Air, 120W Convection Cooled

Approved to EN/CSA/IEC/UL62368-1

2" x 4" x 1.3" Package

12V Fan Output

Ideal for 1U Applications

90% Efficiency Typical at Full Load

Universal Input 90VAC–264VAC

3 Year Warranty

Meets Level V Efficiency Requirements

RoHS Compliant



MODEL SELECTION

Model Number	Volts*	Output Current		Fan Output	Ripple & Noise**	Total Regulation	OVP*** Threshold***
		w/200LFM air	Convection				
CINT1175A1206K01	12V	14.6A	10.0A	12VDC/04.A	0.5%RMS, 1.2% pk-pk	±3%	14.0V ± 1.1V
CINT1175A1506K01	15V	11.7A	8.0A	12VDC/04.A	0.5%RMS, 1.0% pk-pk	±3%	18.5V ± 1.5V
CINT1175A2406K01	24V	7.3A	5.0A	12VDC/04.A	0.5%RMS, 1.2% pk-pk	±3%	28.0V ± 2.5V
CINT1175A4806K01	48V	3.6A	2.5A	12VDC/04.A	0.5%RMS, 1.0% pk-pk	±3%	55.0V ± 4.0V
CINT1175A5606K01	56V	3.1A	2.1A	12VDC/04.A	0.5%RMS, 1.0% pk-pk	±3%	59.0V ± 1.0V

Notes:

- * Total convection power is 120 watts.
- ** Measured with noise probe directly across output terminals, and load terminated with 0.1μF ceramic and 10μF low ESR capacitors.
- *** Output adjustment on 56 volts model will not exceed 56.2 volts.



INPUT

Input Voltage and Frequency	100VAC–240VAC, ±10%, 47Hz–63Hz, 1Ø 120VDC–370VDC
Input Current	115VAC: 2A, 230VAC: 1A
Inrush Current	264VAC, cold start: will not exceed 50A
Input Fuse	4A, 250VAC fuse provided on all models
Earth Leakage Current	<350µA@264VAC, 60Hz, NC
Efficiency	90% typical at 115VAC

EMI/EMC COMPLIANCE

Conducted Emissions	EN55011/22 Class B, FCC Part 15, Subpart B, Class B
Radiated Emissions	EN55011/22 Class A, FCC Part 15, Subpart B, Class A w/6db margin
Static Discharge Immunity	EN61000-4-2, Criteria A, 6kV Contact Discharge, 8kV air discharge
Radiated RF Immunity	EN61000-4-3, 3V/m, Criteria A
EFT/Burst Immunity	EN61000-4-4, 2kV/5kHz, Criteria A
Line Surge Immunity	EN61000-4-5, 1kV differential, 2kV common-mode, Criteria A
Conducted RF Immunity	EN61000-4-6, 3Vrms, Criteria A
Power Frequency Magnetic Field Immunity	EN61000-4-8, 3A/m, Criteria A
Voltage Dip Immunity	EN61000-4-11, 0% Vin, 0.5 cycle; 40% Vin, 5 cycles; 70% Vin, 25 cycles; Criteria A
Line Harmonic Emissions	EN61000-3-2, Class A, B, C, & D
Flicker Test	EN61000-3-3, Complies (dmax<6%)

PROTECTION

Overload Protection	Hiccup Mode
Overvoltage Protection	OVP firing reduces output voltage to <50% of nominal in <50mS. See chart for trip range
Short circuit Protection	-40°C to +85°C

AUXILIARY SIGNALS

AC Power Fail	During normal operations, stays HIGH. Signal goes LOW with 5mS warning before loss of DC output from AC failure
DC OK	Open collector logic signal goes and stays HIGH 100mS to 500mS after main output reaches regulation
Inhibit	Connect to inhibit pin to output common to inhibit the DC output

OUTPUT

Output Voltage	See chart
Output Power	175W continuous, with 200 lfm airflow, 120W convection cooled – See chart for specific voltage model ratings
Turn On Time	Less than 2 sec. @115VAC (inversely proportional to input voltage and thermistor temperature)
Hold-up Time	16mS, typical
Output Voltage Adjustment	±5% from nominal
Transient Response	50% load step. $\Delta i/\Delta t$: <0.2A/µS Max Volt Deviation = 3%
Total Regulation	±3%. See chart
Ripple and Noise	See chart
Minimum Load	Not required
Switching Frequency	PFC: 65kHz typical

ENVIRONMENT

Operating Temperature	-10°C to +70°C. Start Up at -40°C, full load
Storage Temperature	-40°C to +85°C
Relative Humidity	5% to 95%, non-condensing
Weight	210 grams
Dimensions	2.0" x 4.0" x 1.3"
Temperature Derating	Derate output power linearly above 50°C to 50% at 70°C
Operating Altitude	Operating: -500 ft. to 10,000 ft. Non-operating: -500 ft. to 40,000 ft.
Vibration	Operating: 0.003g/Hz, 1.5 grams overall, 3 axes, 10 min/axis Non-Operating: 0.026g/Hz, 5.0 grams overall, 3 axes, 1 hr/axis
Shock	Operating: Half-sine, 20gpk, 10mS, 3 axes, 6 shocks total Non-Operating: Half-sine, 40 gpk, 10mS, 3 axes, 6 shocks total

ISOLATION

Isolation Safety Rating	Input-Output: 4000VAC Input-Ground: 1800VAC Output-Ground: 1500VAC
-------------------------	--



RELIABILITY

MTBF	331,105 hours, 175W load, 110VAC input, 25°C ambient
------	--

SAFETY

Safety Standards	Approved to EN/CSA/IEC/UL62368-1
------------------	----------------------------------

MECHANICAL DRAWING

When installing the power supply into the end-product, a non-conductive Insulator should be placed between the unit and any conductive metal chassis or mounting platform.

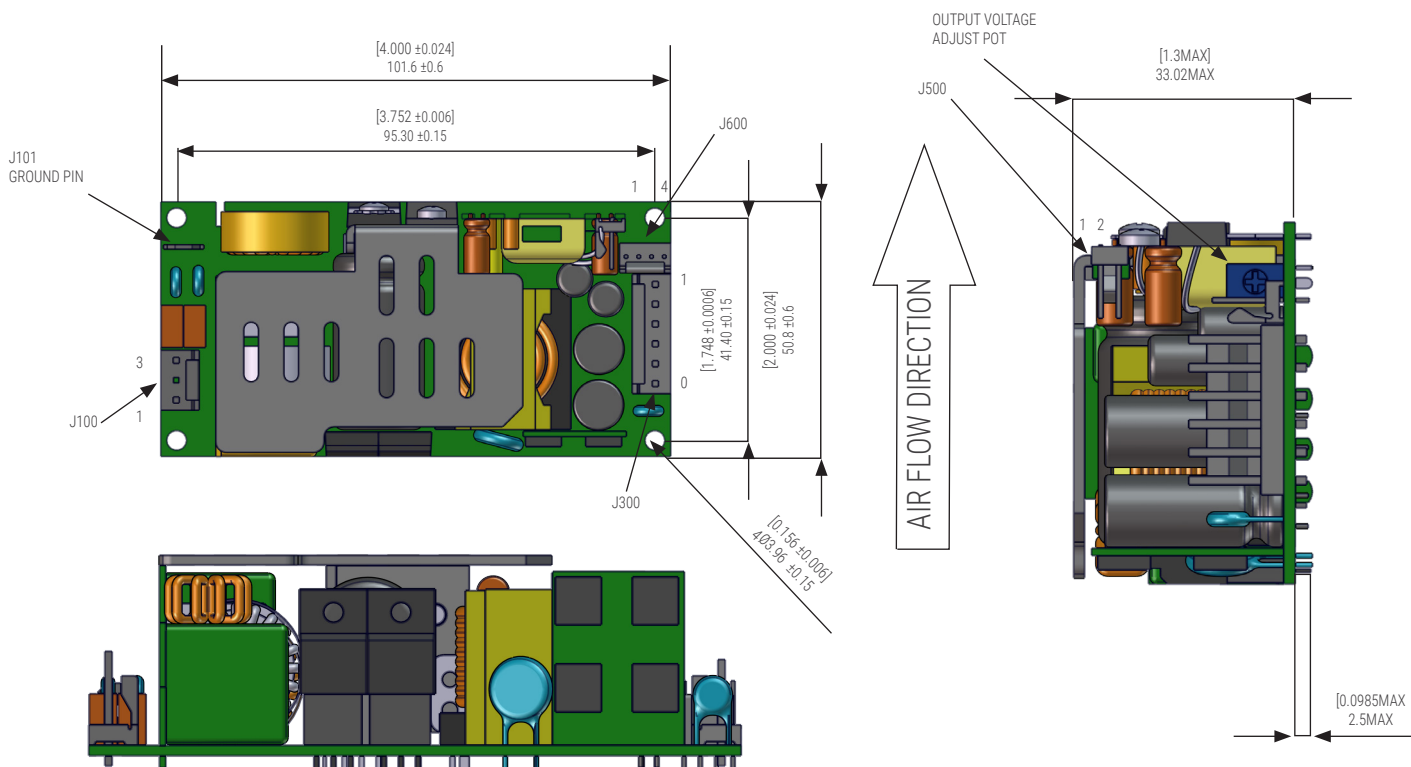

CONNECTOR INFORMATION

Input Connector J100	Ground J101	DC Output Connector J300	Fan Output Connector J500	Signal Connector J600
PIN 1) AC LINE PIN 2) EMPTY PIN 3) AC NEUTRAL	0.187 x 0.032 FASTON TAB	PIN 1) +Vout PIN 4) -Vout PIN 2) +Vout PIN 5) -Vout PIN 3) +Vout PIN 6) -Vout	PIN 1) +12Vfan PIN 2) RTN	PIN 1) Inhibit PIN 2) PF/DC OK PIN 3, 4) Common
Mating Connector: Molex 09-50-3031 Pins= 08-52-0072	Mating Connector: Molex 01-90020009	Mating Connector: AMP 640250-6 Pins = 640252-1	Mating Connector: Molex 1375820-2 Pins = 1375819	Mating Connector: Molex 1375820-4 Pins = 1375819



FAN OUTPUT-J500

J500 provides a 12V@0.4mA output to support a system cooling fan. The fan output is always available when AC input is present, so it also can be used for a 12V standby output is so desired.

AC POWER FAILURE/DC OK AND INHIBIT SIGNALS – J600

AC Power Failure/DC OK

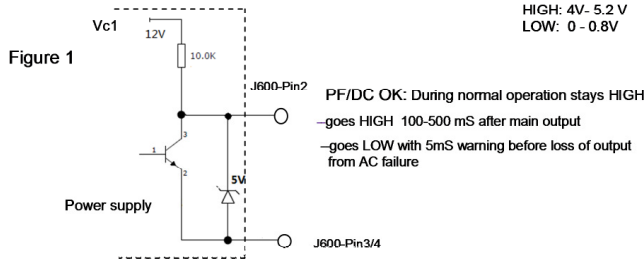

AC Power failure and DC OK signals use the same pin, so the signals can be used as follows:

DC OK: Pin2 = HIGH & Pin1 = HIGH AC Power Failure: Pin2 = LOW & Pin1 = LOW

Inhibit

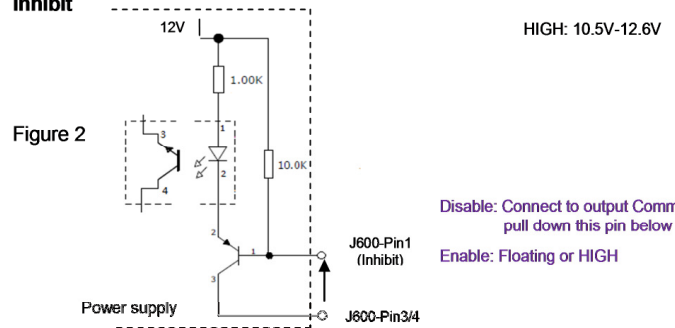

TIMING SEQUENCE

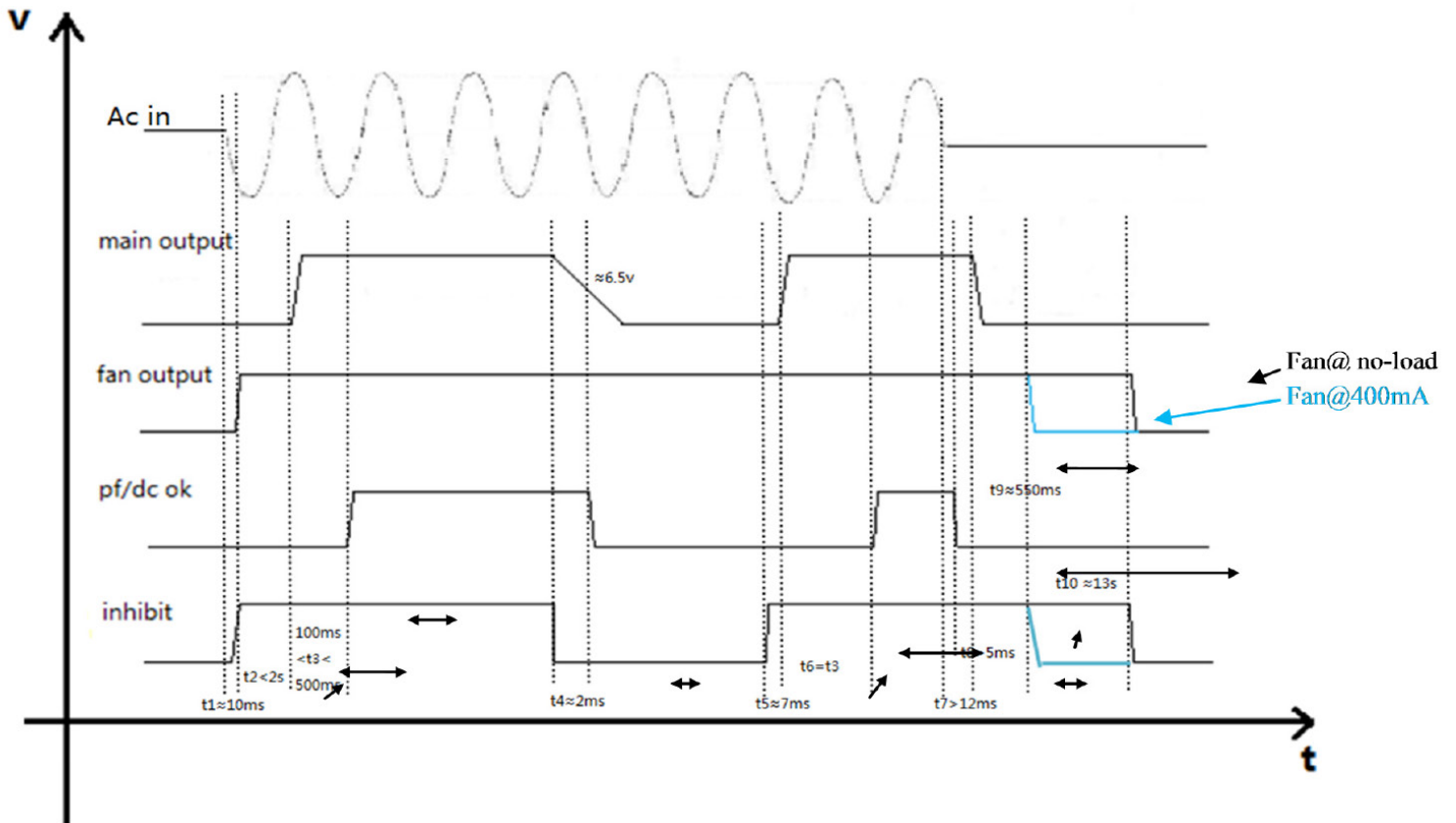



ISOLATION SPECIFICATIONS

Parameter	Conditions/Description	Min	Nom	Max	Units
Insulation Safety Rating	Input/Ground Input/Output Output/Ground		Basic Reinforced n/a		
Electric Strength Test Voltage	Input/Ground Input/Output Output/Ground	1800 4,000 500	-	-	VAC VAC VAC

INPUT SPECIFICATIONS

All specifications apply over specified input voltage, output load, and temperature range, unless otherwise noted.

Parameter	Conditions/Description	Min	Nom	Max	Units
Input Voltage		90	115/230	264	VAC
Turn-On Input Voltage	Ramping up		82.7		VAC
Turn-Off Input Voltage	Ramping down		67.0		VAC
Input Frequency		47	50/60	63	Hz
Inrush Current Limitation	264VAC, cold start	-	-	50	A
Power Factor	V_i / I_o V_i / I_o	0.9	-	-	
Efficiency	CINT1175A1206K01 CINT1175A1506K01 CINT1175A2406K01 CINT1175A4806K01 CINT1175A5606K01	-	90%	-	%



OUTPUT SPECIFICATIONS

Parameter	Conditions/Description	Min	Nom	Max	Units
Output Voltage Setpoint Accuracy CINT1175A1206K01	$V_{i\ nom}, I_{o1}$ @ ADC, $TC = 25^{\circ}C$	-3	-	3	% $V_{o\ nom}$
Output Voltage Setpoint Accuracy CINT1175A1506K01	$V_{i\ nom}, I_{o1}$ @ ADC, $TC = 25^{\circ}C$	-3	-	3	% $V_{o\ nom}$
Output Voltage Setpoint Accuracy CINT1175A2406K01	$V_{i\ nom}, I_{o1}$ @ ADC, $TC = 25^{\circ}C$	-3	-	3	% $V_{o\ nom}$
Output Voltage Setpoint Accuracy CINT1175A4806K01	$V_{i\ nom}, I_{o1}$ @ ADC, $TC = 25^{\circ}C$	-3	-	3	% $V_{o\ nom}$
Output Voltage Setpoint Accuracy CINT1175A5606K01	$V_{i\ nom}, I_{o1}$ @ ADC, $TC = 25^{\circ}C$	-3	-	3	% $V_{o\ nom}$
Output Current V1 Output Current V2	CINT1175A1206K01	0 0	10.0 -	14.6 0.4	ADC ADC
Output Current V1 Output Current V2	CINT1175A1506K01	0 0	8.0 -	11.7 0.4	ADC ADC
Output Current V1 Output Current V2	CINT1175A2406K01	0 0	5.0 -	7.3 0.4	ADC ADC
Output Current V1 Output Current V2	CINT1175A4806K01	0 0	2.5 -	3.6 0.4	ADC ADC
Output Current V1 Output Current V2	CINT1175A5606K01	0 0	2.1 -	3.1 0.4	ADC ADC
Static Line Regulation V1	$V_{i\ min}-V_{i\ max}, V_{i\ nom}, 0\% - 100\% I_{o\ nom}$	-1	-	1	% $V_{o\ nom}$
Static Load Regulation V1 (Droop Characteristic)	$V_{i\ min}-V_{i\ max}, V_{i\ nom}, 0\% - 100\% I_{o\ nom}$	-3	-	3	% $V_{o\ nom}$
Hold-Up Time	Starting at $V_i = 230VAC, P_o\ nom$	-	16	-	mS
Dynamic Load Regulation	Load change = 50%, $di/dt = 0.2A/\mu S$ voltage deviation 3%	0	-	3	% $V_{o\ nom}$
Start-Up Time	$V_{i\ nom}, I_{o\ nom}$	0	-	2	s

PROTECTION

All specifications apply over specified input voltage, output load, and temperature range, unless otherwise noted.

Parameter	Conditions/Description	Min	Nom	Max	Units
Input Fuse	Not user accessible				
Input Transient Protection	2KV(CM) and 1KV(DM) surge			2	KV(CM)
Output	No-load and short circuit proof				Hiccup or Latch
	Short circuit proof				Hiccup or Latch
	Overload (latch style)				Hiccup
Overvoltage Protection	Latch style				Latch
Over temperature Protection	Automatic power shutdown at $TC = 155^{\circ}C$				



CHARACTERISTIC CURVES

Output vs. Temperature

120W convection cooled and 175W continuous with 200 LFM airflow, Derating output power to 50% at 70°C.

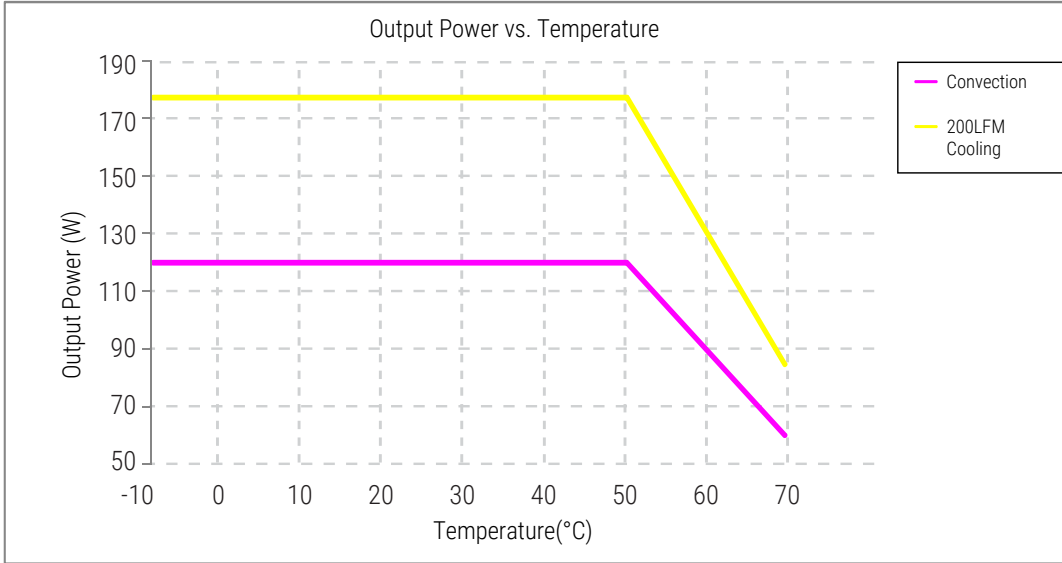

Efficiency vs. Loading

The high efficiency is achieved by using LLC technology, PFC topology minimizing switching losses. Synchronous SCHOTTKY or ultra-fast diode is used as rectifier in CINT1175 family because of high output voltage level.

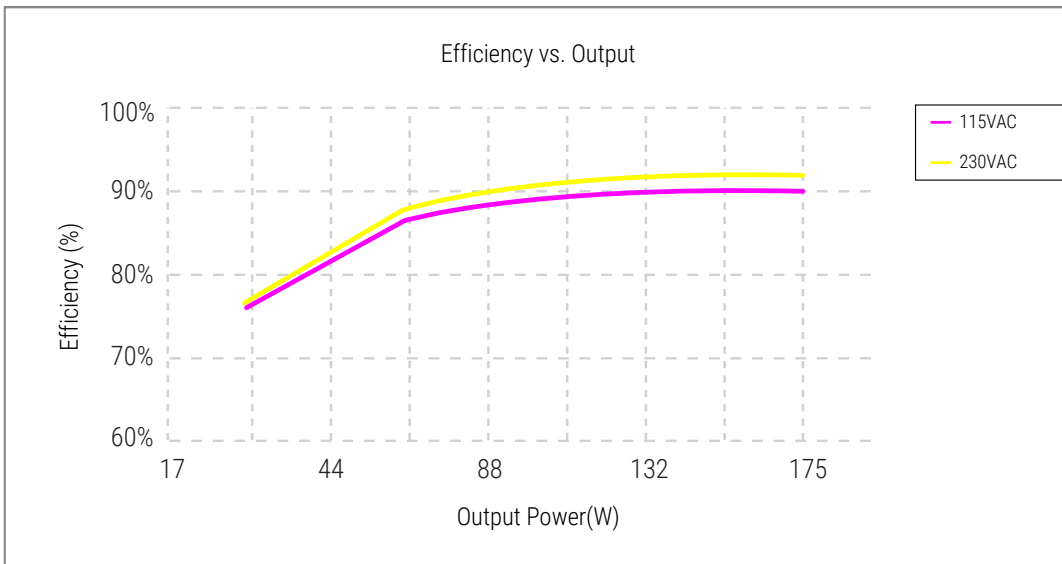



Noise & Ripple

To verify that the output ripple and noise does not exceed the level specified in the product specification. Measured using a scope probe socket with 0.1 μ F ceramic and a 10 μ F electrolysis capacitor connected in parallel across it, BW limit with 20MHz.

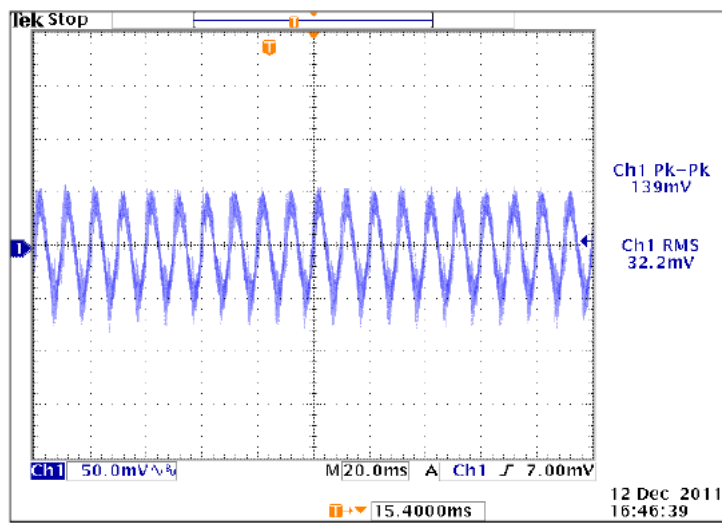
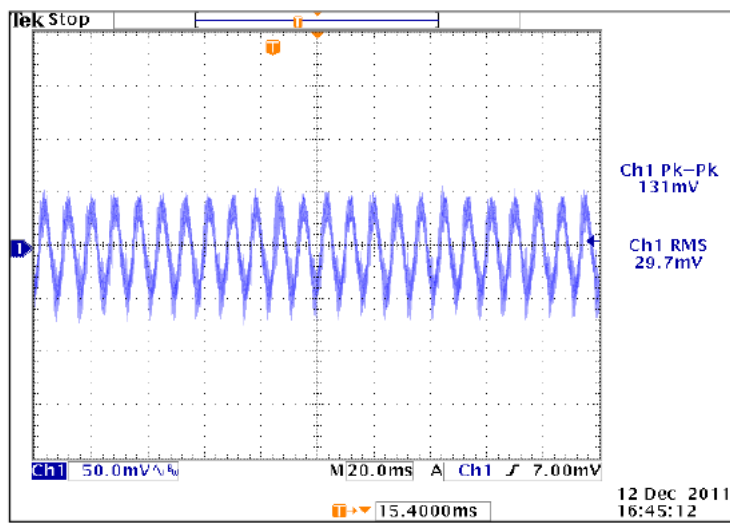

Output Transient Response

50% load step within the regulation limits of minimum and maximum load, $di/dt < 0.2A/\mu$ Sec. Recovery time not specified as there is no laps in regulation with a 50% Load Step. Maximum voltage deviation is 3%. This test is performed on the main output only.

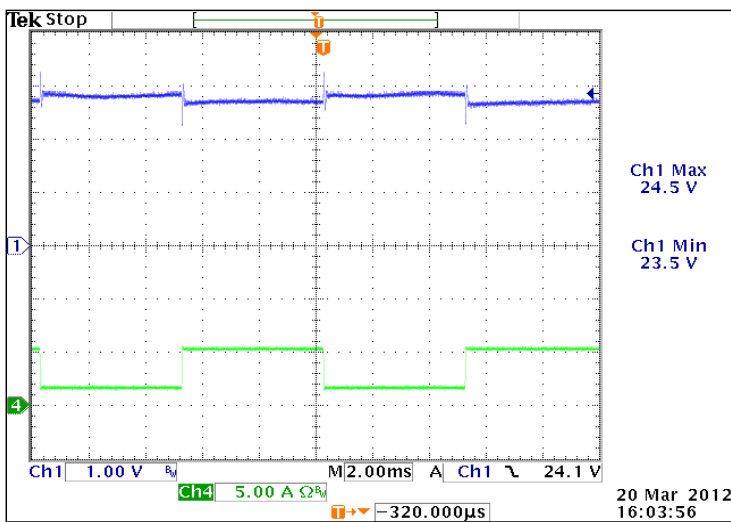
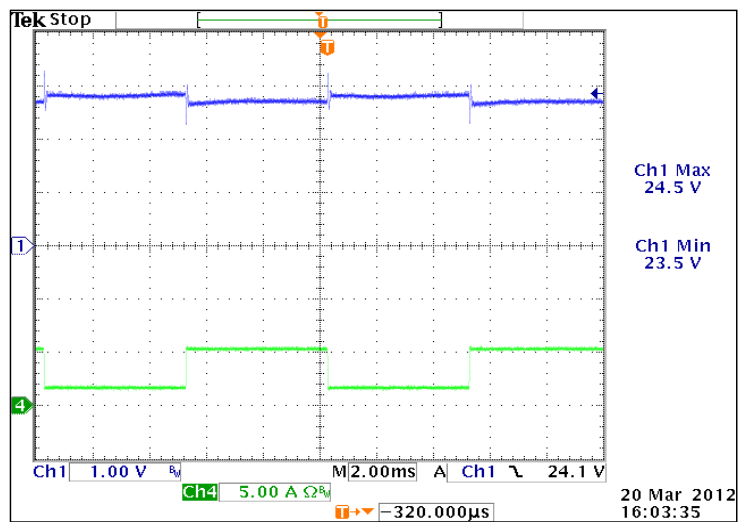



Output Overload Characteristic

Supply shall protect itself against Overload conditions. The Power Supply shall recover from Overload Conditions without operator intervention.

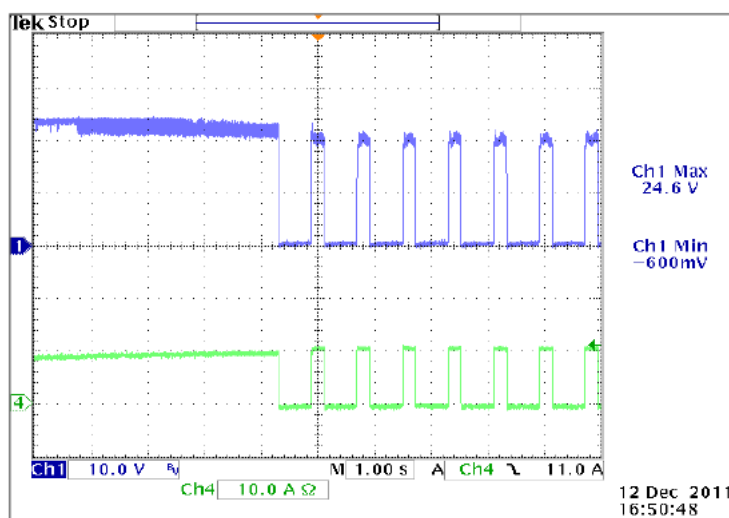
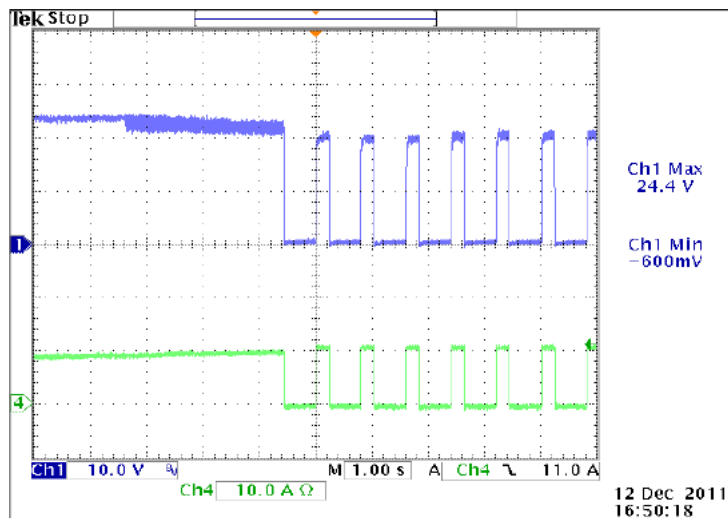

Output Overshoot

When supply is turned on, off or when the load is stepped 100%, the Power Supply Overshoot/Undershoot shall not exceed minimum or maximum of output voltage regulation.

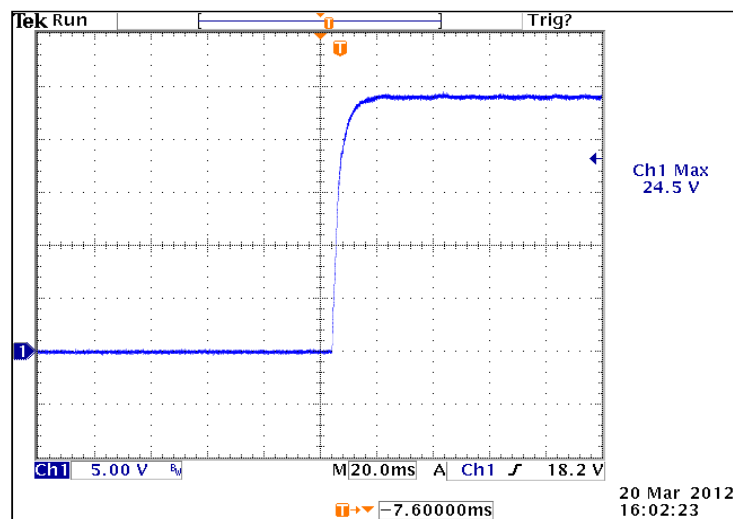
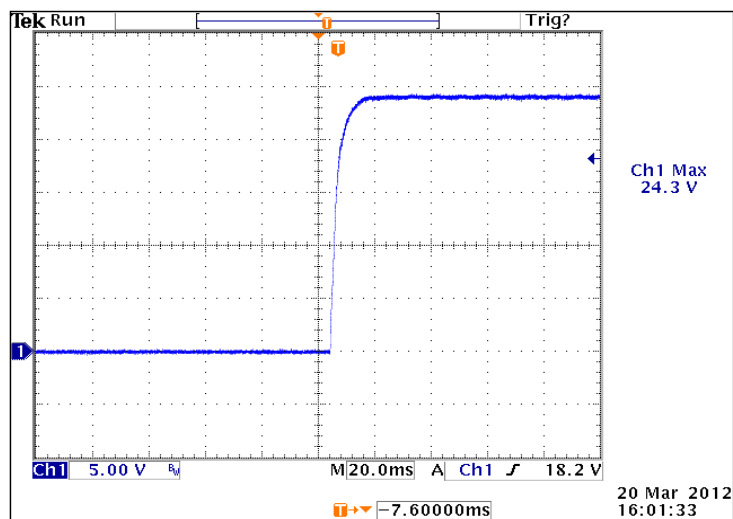

X-ON Electronics

Largest Supplier of Electrical and Electronic Components

Click to view similar products for [Switching Power Supplies](#) category:

Click to view products by [SL Power](#) manufacturer:

Other Similar products are found below :

[70841011](#) [73-551-0005](#) [73-551-0048](#) [PS3E-B12F](#) [PS3E-E12F](#) [AAD600S-4-OP](#) [R22095](#) [KD0204](#) [9021](#) [LDIN100150](#) [LPM000-BBAR-01](#)
[LPX17S-C](#) [EVS57-10R6/R](#) [FP80](#) [FRV7000G](#) [22929](#) [PS3E-F12F](#) [CQM1IA121](#) [40370121900](#) [VI-PU22-EXX](#) [40370121910](#) [LDIN5075](#)
[LPM615-CHAS](#) [LPX140-C](#) [09-160CFG](#) [70841025](#) [VPX3000-CBL-DC](#) [LPM000-BBAR-05](#) [LPM000-BBAR-08](#) [LPM124-OUTA1-48](#)
[LPM000-BBAR-07](#) [LPM109-OUTA1-10](#) [LPM616-CHAS](#) [08-30466-1055G](#) [08-30466-2175G](#) [08-30466-2125G](#) [DMB-EWG](#) [TVQF-1219-](#)
[18S](#) [6504-226-2101](#) [CQM1IPS01](#) [SP-300-5](#) [CQM1-IPS02](#) [VI-MUL-ES](#) [22829](#) [08-30466-0065G](#) [VI-RU031-EWWX](#) [08-30466-0028G](#) [VI-](#)
[LUL-EU](#) [EP3000AC48INZ](#) [VP-C2104853](#)