

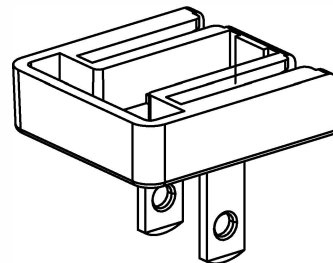

UL AC Plug Dimension(unit:mm)

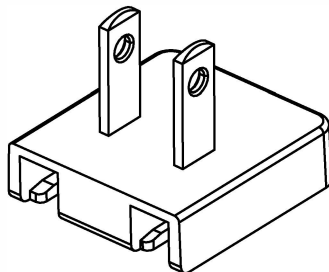
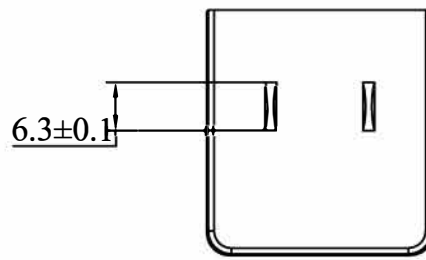
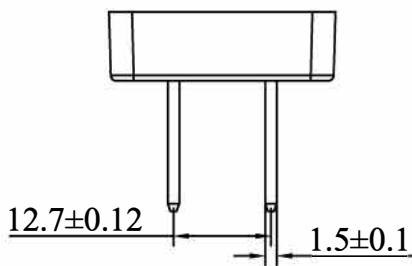
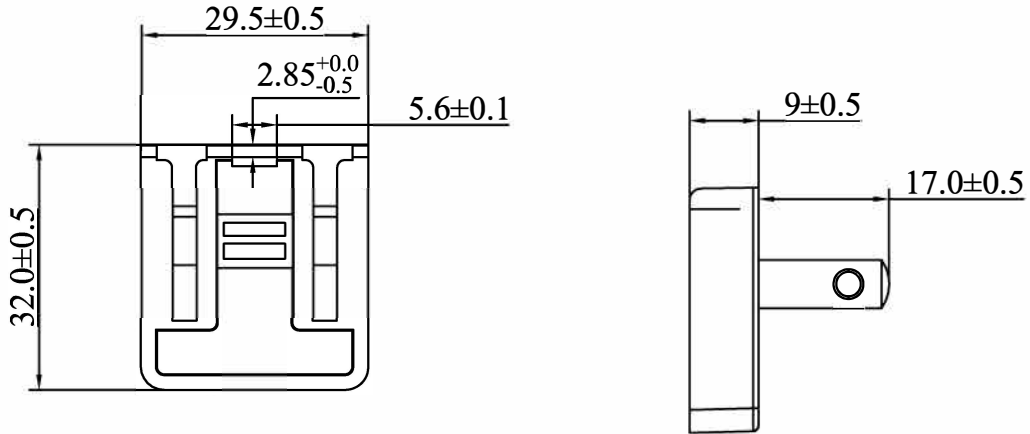

LCP-UL-A Plug Black RoHS+RAHS

300301032000(20100421)

Part No.: KT1001US



Package Method(unit:mm)

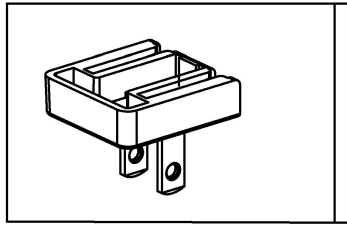

PE bag

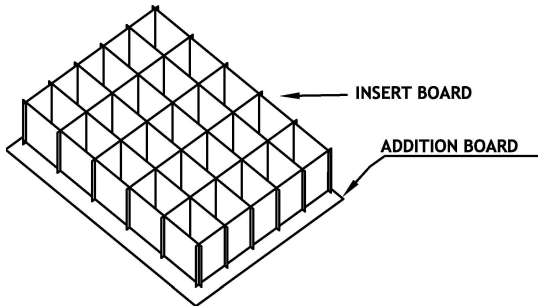

INSERT BOARD

ADDITION BOARD

Technical Requirement:

1. Carton: 2 layers wall, 6mm thickness.
Outline dimension: 540mm × 390mm × 276mm
2. Additional board:
3 mm thickness
3 pieces per carton.
3. Humidity protector:
Each plug packed in a small PE bag.
All boxes packed in a big PE bag with an outer carton.
4. Quantity:
2 layers per carton.
200 pcs. per layer.
400 pcs. per carton.
5. Weight:
Each carton approx. 5.6 kg gross.
Each carton approx. 3.4 kg net.

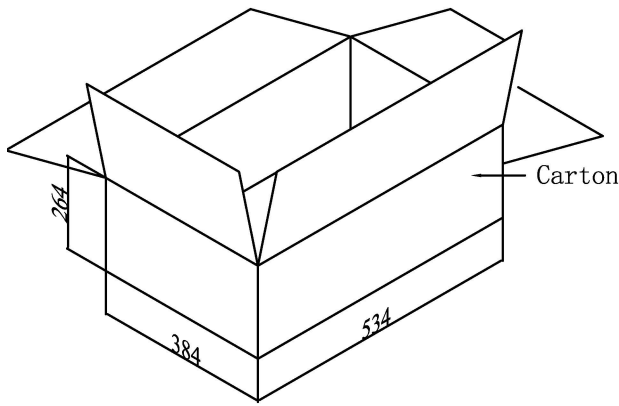

Carton

Side mark

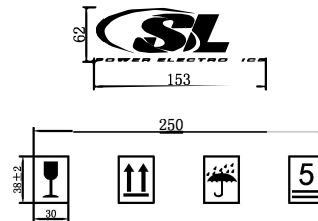

Carton label position

Front mark

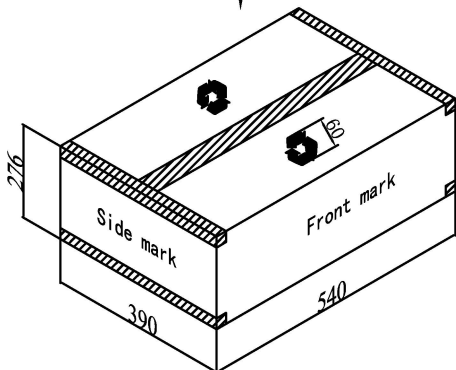

MODEL No: _____ DATE CODE: _____
 DESCRIPTION: _____ S/N: _____ TO _____
 ORDER No: _____ QTY: _____
 VOLUME: 54.0x39.0x27.6(CM) WEIGHT: _____

SL Power Electronics Co.,Ltd

1. Words: SL Electronics Co.,Ltd. is Arial, 20mm high
Other words is Arial, 13mm high
2. Color: Recycle logo 60mm high, center position;
words & logo is black.

X-ON Electronics

Largest Supplier of Electrical and Electronic Components

Click to view similar products for [Wall Mount AC Adapters](#) category:

Click to view products by [SL Power](#) manufacturer:

Other Similar products are found below :

[ADP-163 E](#) [ADP-167 J](#) [ADP-159 A](#) [DA10-050US](#) [WSU075-1000-R13](#) [WSU120-2000-R13](#) [WSU180-1330-13](#) [WSU120-2000-13](#) [WSU150-0800-13](#) [WSU075-3200-13](#) [WSU090-2500-13](#) [WSU050-2000-R13](#) [WSU240-1000-13](#) [WSU150-0560-13](#) [WSU240-0500-R13](#) [WSU075-1500-13](#) [WSU050-3000-13](#) [WSU120-1500-13](#) [WSU150-1200-13](#) [WSU120-1500-R13](#) [WSU240-0750-13](#) [WSU240-1500-13](#) [WSU180-0660-13](#) [WSU090-1300-13](#) [WSU050-1500-13](#) [WSU090-0800-13](#) [WSU120-0700-13](#) [WSU120-3000-13](#) [WSU090-1300-R13](#) [WSU075-1000-13](#) [WSU060-1250-13](#) [WSU050-4000-13](#) [WSU045-1500-R13](#) [AC PLUG-AU3](#) [AC PLUG-MIX3](#) [TRE-A](#) [223-00011](#) [223-00012](#) [223-00010](#) [BB-SMI6B12V-P230C1](#) [FPBAG1-H](#) [POSC05200A-0723-WH](#) [POSC05200A-1335-WH](#) [POSC05200A-1740](#) [POSC05200A-CN-WH](#) [POSC12100A-0723](#) [POSC12100A-1335-WH](#) [POSC12125A-WH](#) [POSC12200A-H-1335](#) [POS05200A-WH-USB-C](#)