

Medical

FEATURES AND BENEFITS

2" x 3.5" x 1.3" Package, Ideal for 1U Applications

10-year Life Design with Premium E-Caps

65 Watts Convection Cooled

Class I and Class II Models

Class B Conducted and Radiated EMI Performance

BF Isolation Type Rated

Designed to meet new IEC 60601-1-2 4th Edition EMC Requirements

Approved to AAMI ES/CSA C22.2/EN/IEC60601-1, 3rd Edition

2 x MOPP Isolation

Internal Temperature Monitor, DC-OK Signal, LED

3 Year Warranty



MODEL SELECTION

Model Number	Class	Volts	Output Current (Convection Cooled)	Efficiency ¹	Ripple & Noise ²	Total Regulation	OVP Threshold
MB65S12K	Class I	12V	5.4A	88%	0.5%	±1%	17.3 ± 2.4V
MB65S12C	Class II	12V	5.4A	88%	0.5%	±1%	17.3 ± 2.4V
MB65S15K	Class I	15V	4.3A	88%	0.5%	±1%	20.1 ± 2.4V
MB65S15C	Class II	15V	4.3A	88%	0.5%	±1%	20.1 ± 2.4V
MB65S24K	Class I	24V	2.7A	89%	0.5%	±1%	29.3 ± 3.5V
MB65S24C	Class II	24V	2.7A	89%	0.5%	±1%	29.3 ± 3.5V
MB65S48K	Class I	48V	1.35A	90%	0.5%	±1%	55.5 ± 4.5V
MB65S48C	Class II	48V	1.35A	90%	0.5%	±1%	55.5 ± 4.5V

Notes : 1. Efficiency, Typical at 115/230Vac, 25°C. See Charts below for load conditions.

2. Measured at 25C using 6 inch twisted pair wires with noise probe directly across output terminals, and load terminated with 0.1µF ceramic and 10µF low ESR capacitors.

3. Part number suffix to include "K" for Class-1 AC input, or "C" suffix for Class-2 AC Input.

CONSULT FACTORY FOR FOLLOWING MODELS, AVAILABILITY MAY VARY

MB65S18K	Class I	18V	3.6A	89%	0.5%	±1%	21.7 ± 2.5V
MB65S18C	Class II	18V	3.6A	89%	0.5%	±1%	21.7 ± 2.5V
MB65S28K	Class I	28V	2.3A	89%	0.5%	±1%	35.2 ± 3.5V
MB65S28C	Class II	28V	2.3A	89%	0.5%	±1%	35.2 ± 3.5V
MB65S32K	Class I	32V	2.0A	89%	0.5%	±1%	41.5 ± 4.5V
MB65S32C	Class II	32V	2.0A	89%	0.5%	±1%	41.5 ± 4.5V



INPUT

AC Input	85-264Vac, single phase. (Safety Approved to 90-264Vac)
Input Current	1.5A at 110Vac, 1A at 240Vac
Inrush Current	40Arms Maximum within a half line cycle, cold start at 25C. See application note
I ² T Characteristic	See Table below
Turn-On Input Voltage	>75Vac ± 8Vac. Full spec performance at 85Vac
Turn-Off Input Voltage	<63Vac ± 8Vac
Input Fuses	3.15A, 250Vac, line and neutral inputs
Earth Leakage Current	<350 µA@264Vac, 60Hz input, NC
No Load Input Power	<0.5W
Efficiency	88% - 90% typical at 115/230Vac, 25°C. See chart for additional details
Overshoot	<2% overshoot at turn-on, <1% overshoot at turnoff, under all conditions

PROTECTION

Over Load Protection (OCP)	115% - 200% of rated output current value. Hiccup Mode, Auto-recovery
Short Circuit Protection (SCP)	Short across the output terminals will not cause damage to the unit. Hiccup Mode, Auto-recovery
Over Voltage Protection (OVP)	Latches off when output voltage is with range as shown in table. Requires AC Power cycle to reset
Over Temperature Protection (OTP)	Power shuts down at temperature of 70°C (typical) at full load. Hiccup Mode, Auto-recovery
Output Reverse Voltage Protection	Outputs protected against momentary reverse current less than 20A peak for less than 10mS with 0.5 average. Sustained reverse current at high levels may damage unit
IPC 610	Class 2

SAFETY

Safety Standards	IEC 60601-1, 3 rd Edition ANSI/AAMI ES60601-1 (2008) CAN/CSA – C22.2 No 60601-1 (2005) DEMKO EN60601-1:2006 Designed to meet China Safety Doc. No. GB4943.1-2011 at 5Km, tropical Standard at 40°C, 93% RH at 120 hours
Shock (IEC 60068-2-27)	Operating: Half-sine shock waveform. Impact Acceleration: 20g, Pulse duration: 11mS. Cycles: 3 times per axis in X,Y, Z direction Non-Operating: Half-sine shock waveform. Impact Acceleration: 100g, Pulse duration: 6mS Cycles: 3 times per direction on 3 axes (X,Y, Z)

OUTPUT

Output Voltage	12V to 48Vdc. See models chart for part numbering
Output Power	65W continuous convection cooled, -20C to 50°C ambient. 85Vac to 264Vac. See chart for derating above 50°C
Turn On Time	<2 Seconds at 110Vac
Rise Time	<30mS, 48V model: < 40mS
Hold-up Time	20mS min. from loss of AC input at 110 Vac, full load, 25°C
Patient Leakage Current (Output to Earth)	<4 mA@264Vac, 60Hz input, NC for BF rating
Touch Current	<90 µA@264Vac, 60 Hz input, NC, also suitable for BF rating <450 µA@264Vac, 60Hz input, SFC, also suitable for BF rating
Transient Response	500µS typ. response time for return to within 0.5% of final value for a 50% load change, Δi/Δt<0.2A/µs. Max. volt. deviation is ±3.5%
Ripple and Noise	0.5% pk-pk
HF Common Mode Noise	0.8 Vrms maximum (input class I)
Total Regulation	±1.0 % for all models
DC OK	During normal operation, this signal is logic HIGH. Signal will go LOW for output less than 80% (typical) of nominal. Green LED will light on PCB top side during normal operation
PSU Temperature	Provides resistive value indicating internal temperature of power supply. See Temp Sensor Conversion Table below

RELIABILITY

MTBF	564,500 hours (ave) @ 110Vac, 25°C, SR332 Issue 6. Consult Factory @ 220Vac, 25°C, SR332 Issue 6
E-Cap Life	>10 Years in use condition of 40°C ambient, at 12h/day, 261 days/year. Additional information on other use profiles available on request

ISOLATION SPECIFICATIONS

Isolation	Input-Output: 4500Vac, 2 x MOPP Input-Ground: 1900Vac, 1 x MOPP Output-Ground: 1900Vac, 1 x MOPP
-----------	--

Notes : All specifications are typical at nominal input, full load, at 25°C ambient unless noted.



ENVIRONMENT

Storage Temperature	-40°C to +85°C
Altitude	Operating: -500m to 3000m Non-operating: -500 to 40,000 feet
Relative Humidity	5% to 95%, non-condensing
Vibration (IEC 60068-2-6) (IEC 60068-2-64)	Operating: Sinusoidal Frequency: 10-500Hz, Impact Acceleration: 1g, Sweep rate: 1 octave/min Cycles: 10 times per axis in X, Y, Z direction Random Vibration: Operating: 0.003g ² /Hz, 1.224grms overall, 3 axes, 10 min per axis, 1-500Hz. Non-Operating: 0.02g ² /Hz, 3.1grms overall, 3 axes, 1 hour per axis, 20-500 Hz
Weight	140g, typical
Dimensions	W: 2.0" x L: 3.5" x H: 1.3" W: 50.8mm x L: 88.9mm x H: 33.02mm

EMI/EMC COMPLIANCE

Conducted Emissions	EN55011/22: Class B, FCC Part 15. Class B: 6db margin typ, Class 1 PSU configuration EN55011/22: Class B, FCC Part 15. Class B: 2db margin typ, Class 2 PSU configuration
Radiated Emissions	EN55011/22: Class B, FCC Part 15. Class B: 3db margin typ, Class 1 PSU configuration EN55011/22: Class B, FCC Part 15. Class B: 3db margin typ, Class 2 PSU configuration
Harmonic Current Emissions	IEC61000-3-2: Class A
Voltage Fluctuations & Flicker	IEC 61000-3-3
Electro Static Discharge Immunity	IEC61000-4-2: Level 4, 8kV Contact Discharge, 15kV air discharge, Criteria A. Also meets proposed IEC60601-1-2, 4 th edition, Table 4
Radiated RF EM Fields Susceptibility	IEC61000-4-3: Level 3, 10V/m, Criteria A. 80MHz-1000 MHz and 3V/m 1.4Ghz to 2.7 GHz. 80% AM at 1kHz. Also meets proposed IEC60601-1-2, 4 th edition, Table 4
Proximity Fields from RF wireless communications Equipment	[IEC60601-1-2: 4 th edition, Table 4]
Rated Power Frequency magnetic fields	IEC61000-4-8: Level 5, 30A/m, 50/60 Hz
Low Frequency magnetic fields	[TBD]
Electrical Fast Transients /Bursts	IEC61000-4-4: Level 3, 2KV, 100Khz rep rate, 40A (PS Output), Criteria A IEC61000-4-4: Level 3, 1kV, 20A, (Other Outputs), Criteria B Also meets proposed IEC60601-1-2, 4 th edition standard, Table 5 & 6.
Surges Line to Line (DM) and Line to Ground (CM)	IEC61000-4-5: Level 3, +/-1kV DM, +/-2kV CM, Criteria A Also meets proposed IEC60601-1-2, 4 th edition standard, Table 5.
Conducted Disturbances induced by RF Fields	IEC61000-4-6: 3V/m & 10 V/m – 0.15 to 80Mhz and 10V/m in ISM and amateur radio bands between 0.15 MHz and 80 MHz, 80% AM at 1 KHz. Also meets proposed IEC60601-1-2, 4 th edition standard, Table 5 & 6 & 8.

Notes : Performance criteria are based on definitions contained in EN55024. Performance criteria are:

- A – Normal performance during and after the test,
- B – Temporary degradation, self-recoverable,
- C – Temporary degradation, operator intervention required to recover the operation,
- D – Permanent damage may occur.



EMI/EMC COMPLIANCE

Rated Power Frequency Magnetic Fields Test	IEC61000-4-8: Level 4 (30A/m), Criteria A Also meets proposed IEC60601-1-2, 4 th edition standard, Table 4 enclosure port
Voltage Dips	IEC61000-4-11: 100% dip for 10mS, at 0°, 45°, 90°, 135°, 180°, 225°, 270° and 315°, Criteria A; 60% dip for 100mS, Criteria B; 30% dip for 500mS (25/30 cycles) 1 \emptyset , and 0° for 500mS, Criteria A. Also meets proposed IEC60601-1-2, 4 th edition standard, Table 5
Enclosure Port Immunity to RF wireless communications equipment	IEC61000-4-3

Notes : Performance criteria are based on definitions contained in EN55024. Performance criteria are:

- A – Normal performance during and after the test,
- B – Temporary degradation, self-recoverable,
- C – Temporary degradation, operator intervention required to recover the operation,
- D – Permanent damage may occur.

ISOLATION SPECIFICATIONS

Parameter	Conditions/Description	Min	Nom	Max	Units
Insulation Safety Rating	Input/Ground		1 MOPP		
	Input/Output		2 MOPP		
	Output/Ground		1 MOPP		
Electric Strength Test Voltage	Input/Ground	1900			Vac
	Input/Output	4500	-	-	Vac
	Output/Ground	1900			Vac

MECHANICAL DRAWING

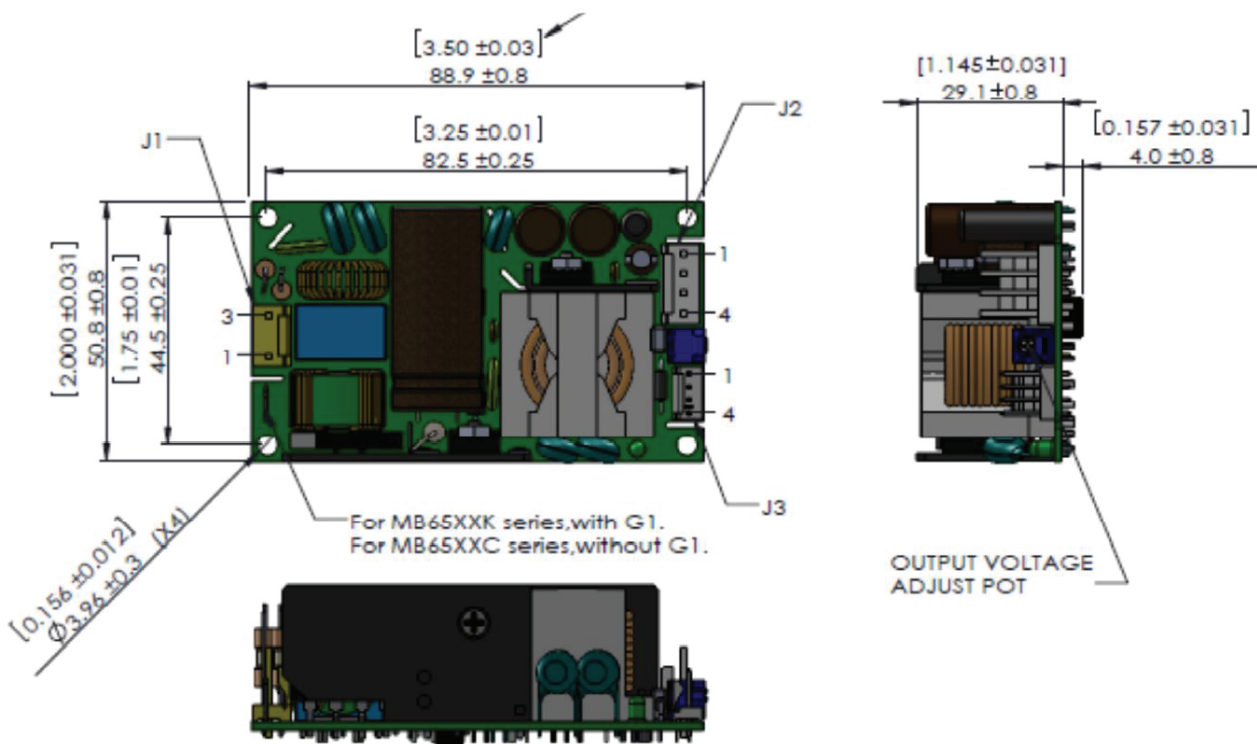



CONNECTOR INFORMATION

Input Connector J1	DC Output Connector J2	Ground Connector G1	Signal Connector J3
PIN 1) AC Line PIN 2) Empty (removed) PIN 3) AC Neutral	Pin 1) (+V1) Pin 2) (+V1) Pin 3) (RTN) Pin 4) (RTN)	FG 0.187" Quickconnect tab	PIN 1) RTN PIN 2) DC_OK Pin 3) TEMP SENSOR (+) Pin 4) TEMP SENSOR (-)
Mating Connector	Mating Connector	Mating Connector	Mating Connector
Tyco/AMP 640250-3 Pins: 640252-2	Tyco/AMP 640250-4 Pins: 640252-2	Molex 01-90020005	Tyco/AMP 1375820-4 Pins: 1375819

1. DC-OK SIGNAL (J-3)

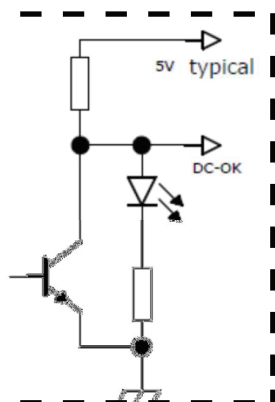

During normal operation, this signal is logic HIGH for output more than 85% (typical) of normal. Signal will go LOW for output less than 80% (typical) of normal. Green LED will light on PCB top side during normal operation

2. TEMPERATURE SENSOR SIGNAL (J-3)

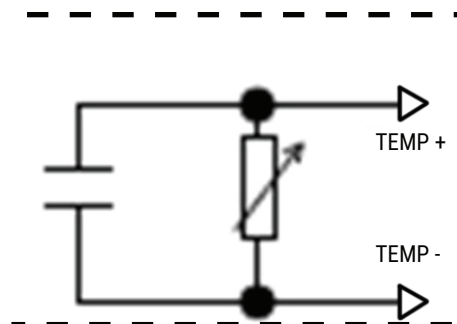

INTERNAL TEMPERATURE SENSOR CONVERSION TABLE

Resistance Value across connector J3, pins 3-4	Internal Temperature
6,040K ohms	-20°C
3,227K ohms	-10°C
1,788K ohms	0°C
1,025K ohms	10°C
605.1K ohms	20°C
367.6K ohms	30°C
229.2K ohms	40°C
146.4K ohms	50°C
95.62K ohms	60°C
63.80K ohms	70°C
43.40K ohms	80°C
30.07K ohms	90°C
21.19K ohms	100°C

Notes : 1) Tolerances: -20°C to 60°C: +/- 4°C; 70°C to 80°C: +/- 5°C; 90°C to 100°C: +/- 6°C.



3. TIMING SEQUENCE

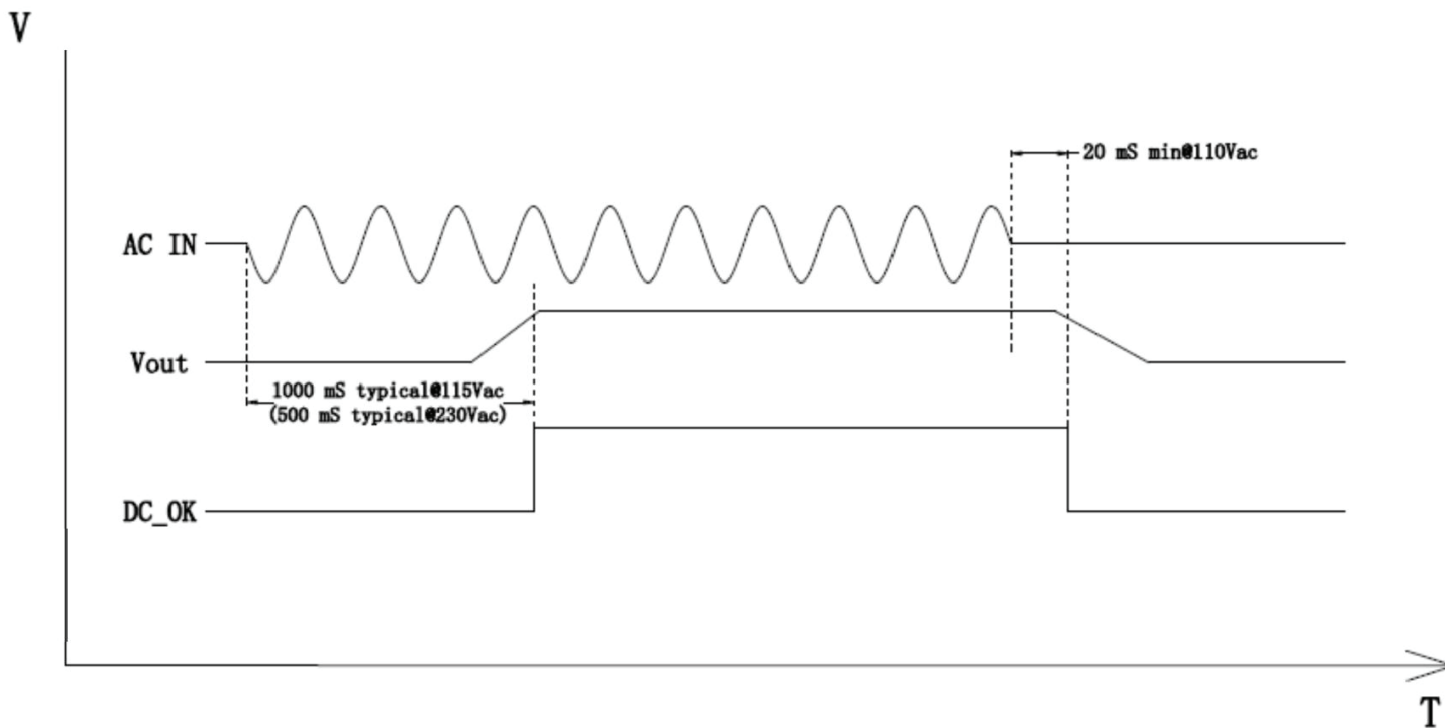

4. PROTECTION

All specifications apply over specified input voltage, output load, and temperature range, unless otherwise noted.

Parameter	Conditions/Description	Min	Nom	Max	Units
Input Fuses	Not user accessible			2	KV (CM)
Input Transient Protection	2KV(CM) and 1KV(DM) surge				
Output	No-load and short circuit proof short circuit proof overload			Hiccup Hiccup Hiccup	
Overvoltage Protection	Latch style			Latch	
Over temperature Protection	Automatic power shutdown at TA = 80°C(typical)				

5. INRUSH CURRENT, PEAK (I²T RATING)

Measured at 264Vac, 50°C at 100% loading, 70°C at de-rated load condition

Mode	50°C - I ² T rating (A ² Seconds, Typical)	70°C - I ² T rating (A ² Seconds, Typical)
12V Model	8.5	11.0
15V Model	6.5	13.2
24V Model	10.9	12.2
48V Model	10.4	11.1



6. CHARACTERISTIC CURVES

6.1 OUTPUT VS. TEMPERATURE

Output Power - Conection vs. Ambient Temperature

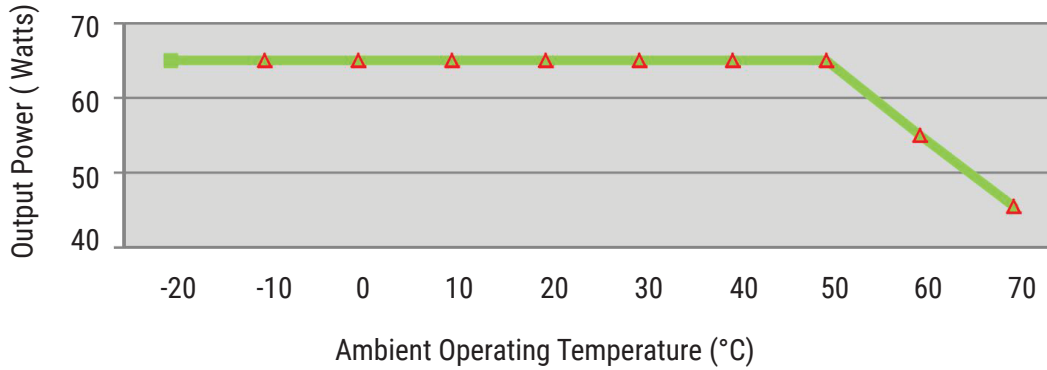

65W convection cooled at -20°C to 50°C operating ambient temperature. De-rated output power to 45.5W at 70°C.

6.2 EFFICIENCY VS. LOADING AT AC INPUT VOLTAGES

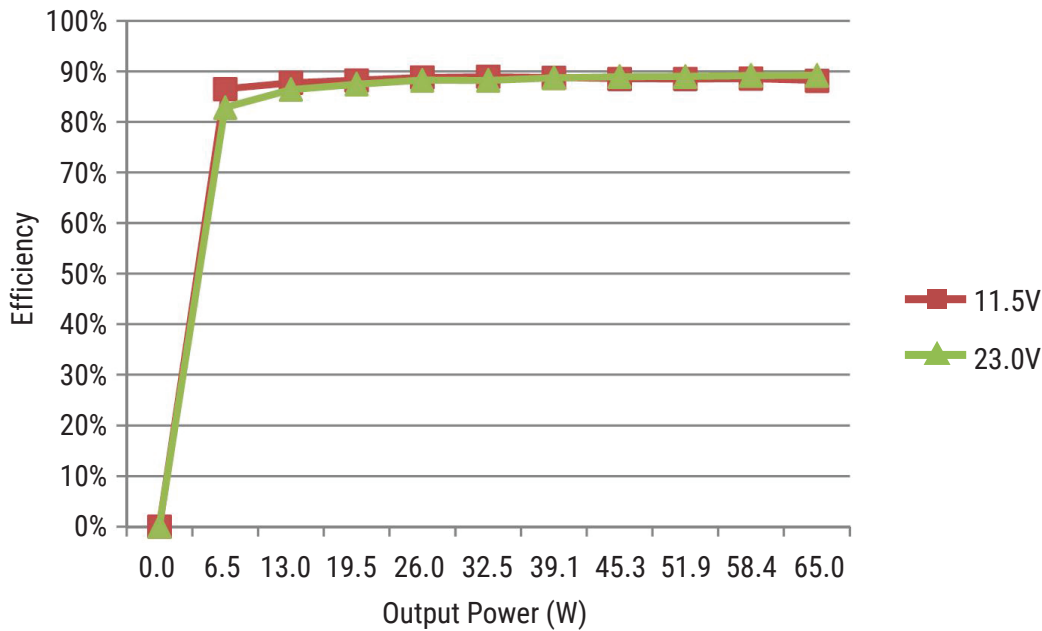

High efficiency is achieved by using QR technology. Synchronous MOSFETs or ultra-fast diodes are used as rectifiers in MB65S family.



6.3 EFFICIENCY VS. LOADING

The charts below detail the MB65 efficiency vs input voltage and output loading conditions at 25°C, 50°C and 70°C under de-rated power.

25°C ambient

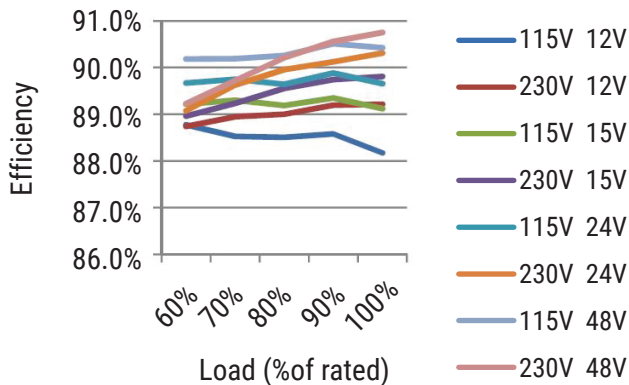

50°C ambient

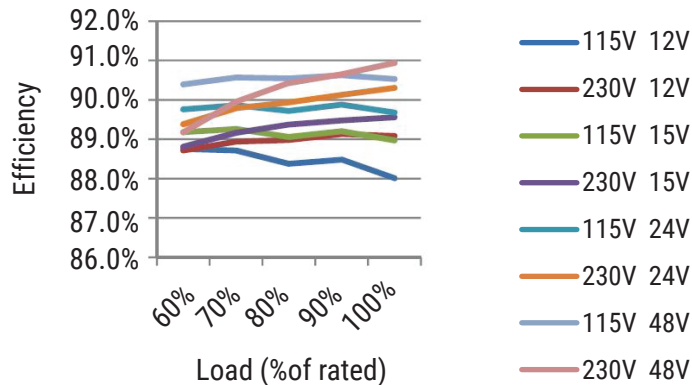

70°C ambient

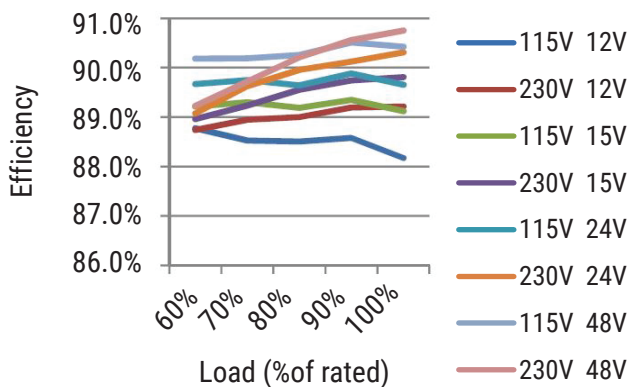

6.4 RIPPLE & NOISE

Measured using a scope probe socket with 0.1µF ceramic and a 10µF electrolytic capacitor connected in parallel across it. Bandwidth limit is 20MHz.

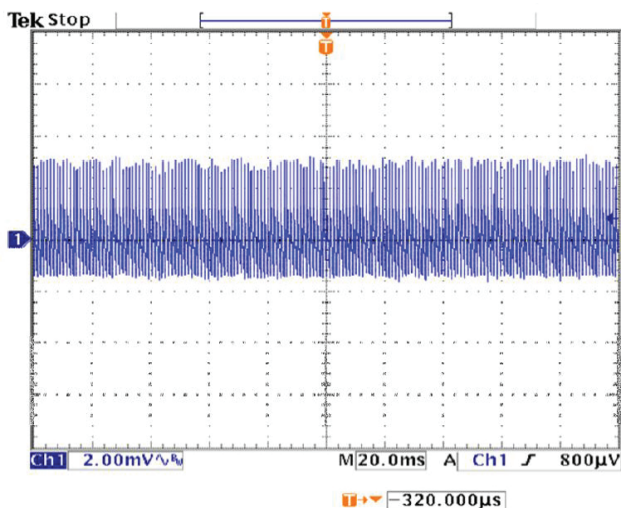

12V Out, No Load, 85VAC, 60HZ

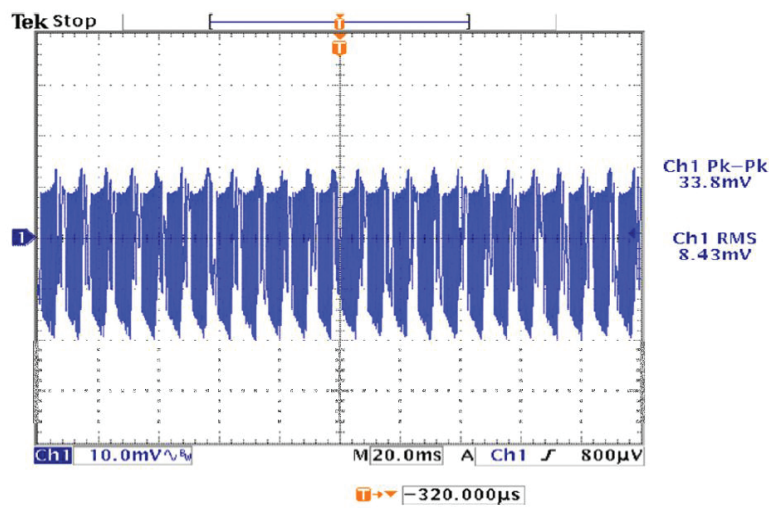

12V Out, No Load, 85VAC, 60HZ



6.4 RIPPLE & NOISE (CONT'D)

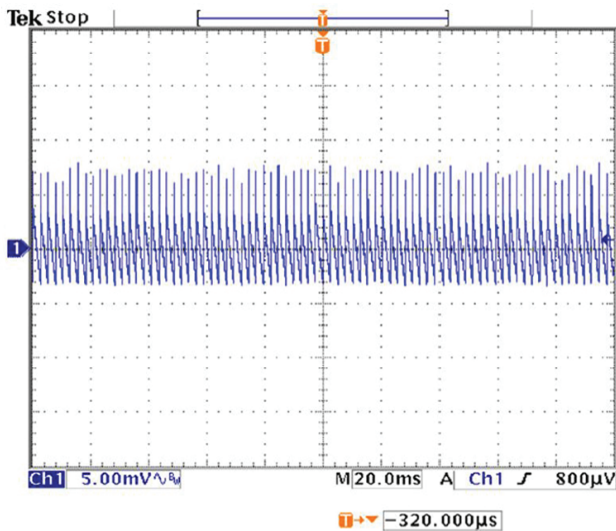

12V Out, No Load, 264VAC, 50HZ

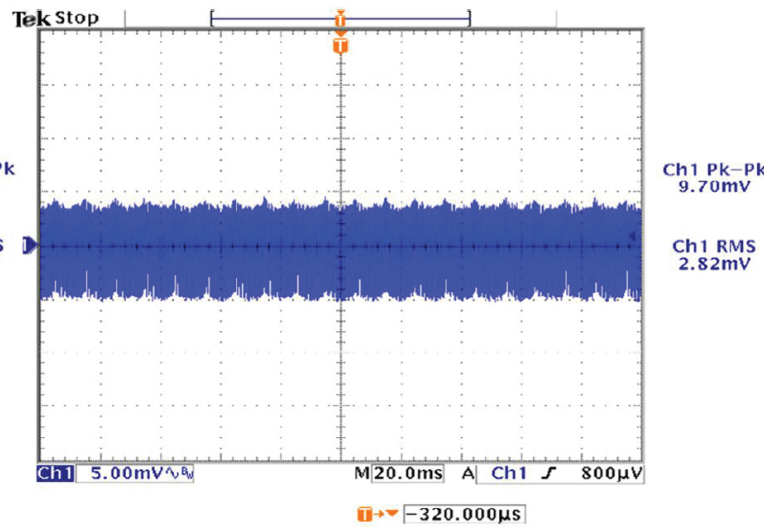

12V Out, No Load, 264VAC, 50HZ

6.5 OUTPUT TRANSIENT RESPONSE

50% load step within the regulation limits of minimum and maximum load, $dI/dt < 0.2A/\mu\text{Sec}$.

Recovery time not specified as there are no lapse in regulation with a 50% Load Step. Maximum voltage deviation is 3.5%

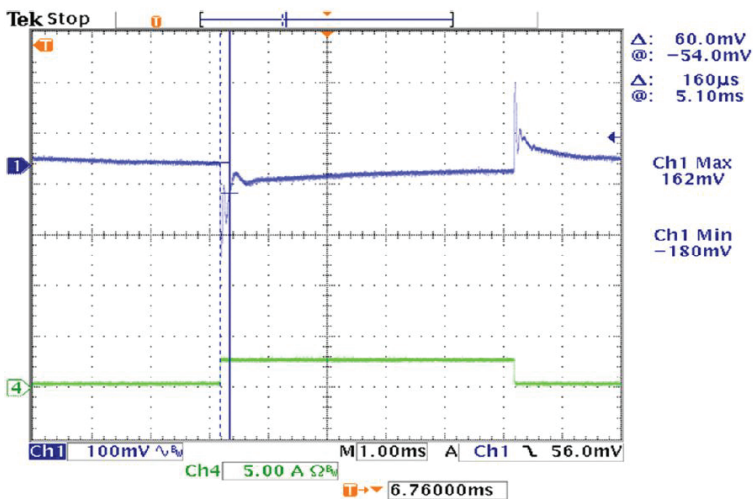

5%~50% Load Transient (AC) at 25°C@115V

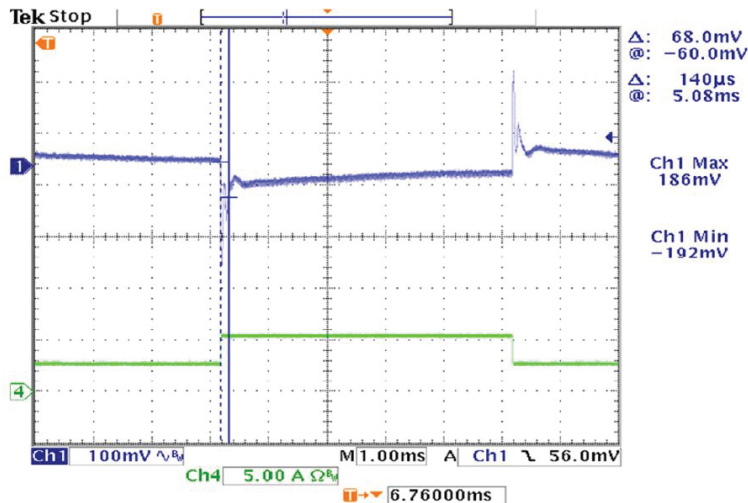

5%~50% Load Transient (AC) at 25°C@115V



6.6 OUTPUT OVERLOAD CHARACTERISTIC

Supply protects itself against overload conditions. The Power Supply recovers from Overload Conditions without operator intervention.

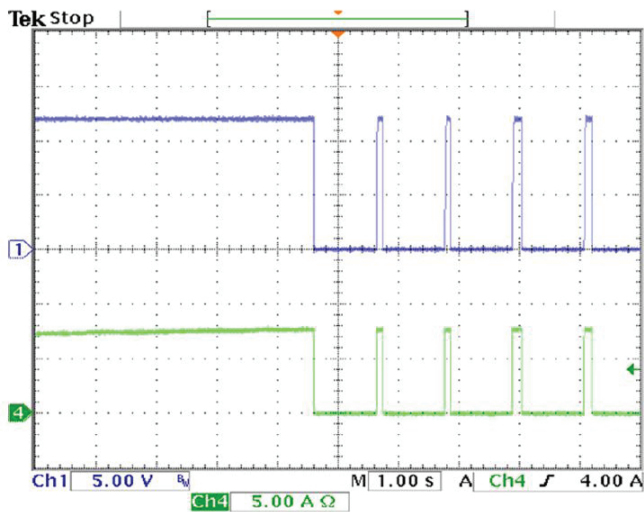

12v Out, 100Vac

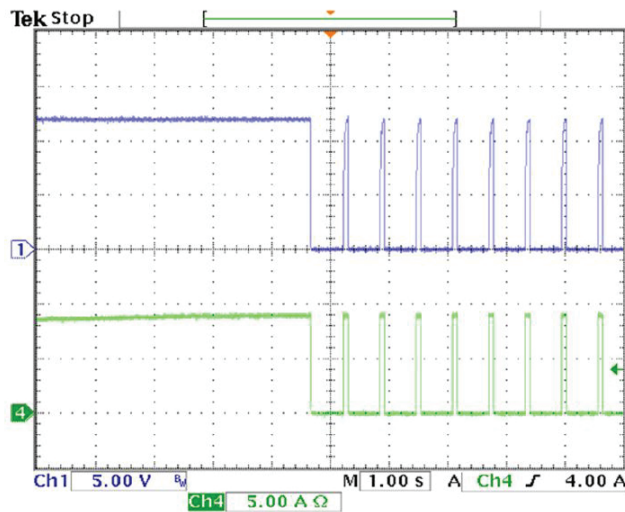

12V Out, 240Vac

6.7 TURN-ON TIME

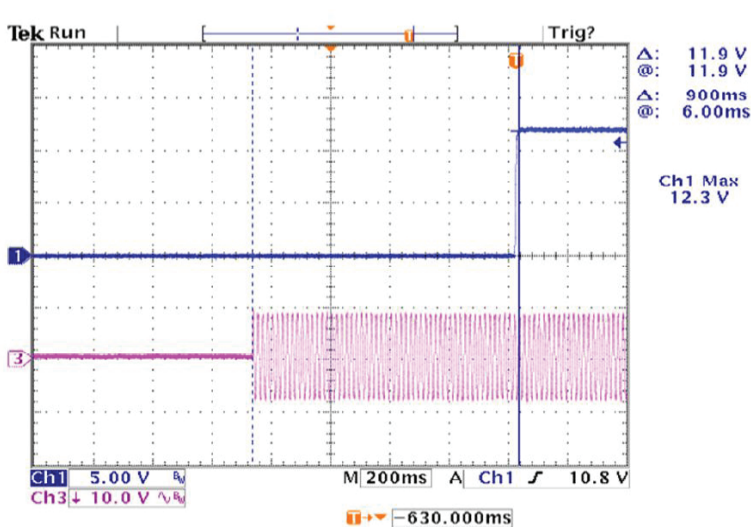

12v Out, Full Load, 115Vac

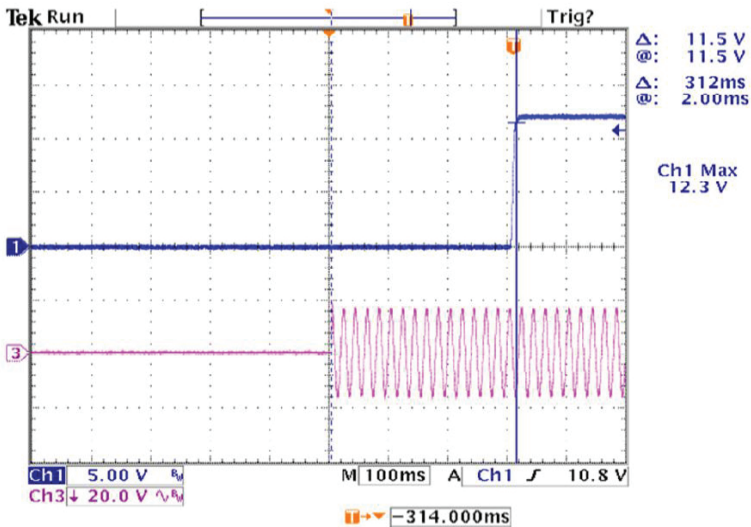

12V Out, Full Load, 230Vac

X-ON Electronics

Largest Supplier of Electrical and Electronic Components

Click to view similar products for [Switching Power Supplies](#) category:

Click to view products by [SL Power](#) manufacturer:

Other Similar products are found below :

[70841011](#) [73-551-0005](#) [73-551-0048](#) [PS3E-B12F](#) [PS3E-E12F](#) [AAD600S-4-OP](#) [R22095](#) [KD0204](#) [9021](#) [LDIN100150](#) [LPM000-BBAR-01](#)
[LPX17S-C](#) [EVS57-10R6/R](#) [FP80](#) [FRV7000G](#) [22929](#) [PS3E-F12F](#) [CQM1IA121](#) [40370121900](#) [VI-PU22-EXX](#) [40370121910](#) [LDIN5075](#)
[LPM615-CHAS](#) [LPX140-C](#) [09-160CFG](#) [70841025](#) [VPX3000-CBL-DC](#) [LPM000-BBAR-05](#) [LPM000-BBAR-08](#) [LPM124-OUTA1-48](#)
[LPM000-BBAR-07](#) [LPM109-OUTA1-10](#) [LPM616-CHAS](#) [08-30466-1055G](#) [08-30466-2175G](#) [08-30466-2125G](#) [DMB-EWG](#) [TVQF-1219-](#)
[18S](#) [6504-226-2101](#) [CQM1IPS01](#) [SP-300-5](#) [CQM1-IPS02](#) [VI-MUL-ES](#) [22829](#) [08-30466-0065G](#) [VI-RU031-EWWX](#) [08-30466-0028G](#) [VI-](#)
[LUL-EU](#) [EP3000AC48INZ](#) [VP-C2104853](#)