

## Features

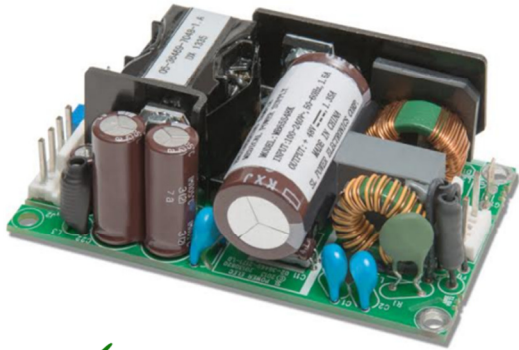

- 2" x 3.5" x 1.3" Package, Ideal for 1U Applications
- 10-year life design with Premium E-Caps
- 65 Watts convection cooled
- Class I and Class II models
- Class B Conducted and Radiated EMI Performance
- BF Isolation Type Rated
- Designed to meet new IEC 60601-1-2 4<sup>th</sup> Edition EMC Requirements
- Approved to AAMI ES/CSA C22.2/EN/IEC60601-1, 3<sup>rd</sup> Edition
- 2 x MOPP Isolation
- Internal Temperature Monitor, DC – OK Signal, LED
- 3 Year Warranty

## Description

A superior performance 65 Watt AC to DC power supply designed for next generation medical applications. Feature rich and highly efficient, MB65 product family can easily fit in a 1U chassis and provides 65 Watts of convection power. Input & output and internal temperature monitoring/alarms are features of the MB65 family. All models are CE marked to low voltage directive and approved to AAMI ES/CSA C22.2 No./EN/IEC60601-1, 3<sup>rd</sup> edition. The design takes into consideration the pending international release of the new IEC 60601-1-2, 4<sup>th</sup> Edition EMC requirements. With low leakage current performance, the power supplies are BF rated.

## Model Selection

Model Number	Class	Volts	Output Current (Convection Cooled)	Efficiency <sup>1</sup>	Ripple & Noise <sup>2</sup>	Total Regulation	OVP Threshold
MB65S12K	Class I	12V	5.4A	88%	0.5%	±1%	17.3 ± 2.4V
MB65S12C	Class II	12V	5.4A	88%	0.5%	±1%	17.3 ± 2.4V
MB65S15K	Class I	15V	4.3A	88%	0.5%	±1%	20.1 ± 2.4V
MB65S15C	Class II	15V	4.3A	88%	0.5%	±1%	20.1 ± 2.4V
MB65S24K	Class I	24V	2.7A	89%	0.5%	±1%	29.3 ± 3.5V
MB65S24C	Class II	24V	2.7A	89%	0.5%	±1%	29.3 ± 3.5V
MB65S48K	Class I	48V	1.35A	90%	0.5%	±1%	55.5 ± 4.5V
MB65S48C	Class II	48V	1.35A	90%	0.5%	±1%	55.5 ± 4.5V

Notes:

1) Efficiency, Typical at 115/230Vac, 25°C. See Charts below for load conditions.

2) Measured at 25C using 6 inch twisted pair wires with noise probe directly across output terminals, and load terminated with 0.1µF ceramic and 10µF low ESR capacitors.

3) Part number suffix to include "K" for Class-1 AC input, or "C" suffix for Class-2 AC Input

Consult Factory for following Models, availability may vary.

MB65S18K	Class I	18V	3.6A	89%	0.5%	± 1%	21.7 ± 2.5V
MB65S18C	Class II	18V	3.6A	89%	0.5%	± 1%	21.7 ± 2.5V
MB65S28K	Class I	28V	2.3A	89%	0.5%	± 1%	35.2 ± 3.5V
MB65S28C	Class II	28V	2.3A	89%	0.5%	± 1%	35.2 ± 3.5V
MB65S32K	Class I	32V	2.0A	89%	0.5%	± 1%	41.5 ± 4.5V
MB65S32C	Class II	32V	2.0A	89%	0.5%	± 1%	41.5 ± 4.5V

## General Specifications

<b>AC Input</b>	85-264Vac, single phase. (Safety Approved to 90-264Vac).	<b>Turn On Time</b>	<2 Seconds at 110Vac.
<b>Input Current</b>	1.5A at 110Vac, 1A at 240Vac	<b>Rise Time</b>	<30mS, 48V model: < 40mS
<b>Inrush Current</b>	40Arms Maximum within a half line cycle, cold start at 25C. See application note.	<b>Hold-up Time</b>	20mS min. from loss of AC input at 110 Vac, full load, 25°C.
<b>I<sup>2</sup>T Characteristic</b>	See Table below.	<b>Over Load Protection (OCP)</b>	115% - 200% of rated output current value. Hiccup Mode, Auto-recovery
<b>Turn-On Input Voltage</b>	>75Vac ± 8Vac. Full spec performance at 85Vac.	<b>Short Circuit Protection (SCP)</b>	Short across the output terminals will not cause damage to the unit. Hiccup Mode , Auto-recovery
<b>Turn-Off Input Voltage</b>	<63Vac ± 8Vac	<b>Over Voltage Protection (OVP)</b>	Latches off when output voltage is with range as shown in table. Requires AC Power cycle to reset
<b>Input Fuses</b>	3.15A, 250Vac, line and neutral inputs	<b>Over Temperature Protection (OTP)</b>	Power shuts down at temperature of 70°C (typical) at full load. Hiccup Mode , Auto-recovery
<b>Earth Leakage Current</b>	<350 µA@264Vac, 60Hz input, NC	<b>Output Reverse Voltage Protection</b>	Outputs protected against momentary reverse current less than 20A peak for less than 10mS with 0.5A average. Sustained reverse current at high levels may damage unit.
<b>Patient Leakage Current (Output to Earth)</b>	<4 mA@264Vac, 60Hz input, NC for BF rating	<b>Isolation</b>	Input-Output: 4500Vac, 2 x MOPP Input-Ground: 1900Vac, 1 x MOPP Output-Ground: 1900Vac, 1 x MOPP
<b>Touch Current</b>	<90 µA@264Vac, 60 Hz input, NC, also suitable for BF rating <450 µA@264Vac, 60Hz input, SFC, also suitable for BF rating	<b>Turn-On &amp; Operating Temperature</b>	-20°C to +70°C. Turn on Temperature = -40°C at >=120Vac, allowing [x] seconds for stabilization. De-rated output power at 70°C = 45.5W
<b>No Load Input Power</b>	<0.5W	<b>Storage Temperature</b>	-40°C to +85°C
<b>Efficiency</b>	88% - 90% typical at 115/230Vac, 25°C. See chart for additional details	<b>Altitude</b>	Operating: -500m to 3000m Non-operating: -500 to 40,000 feet
<b>Output Power</b>	65W continuous convection cooled, -20C to 50°C ambient. 85Vac to 264Vac. See chart for de-rating above 50°C.	<b>Relative Humidity</b>	5% to 95%, non-condensing
<b>Transient Response</b>	500µS typ. response time for return to within 0.5% of final value for a 50% load change, Δi/Δt< 0.2A/µs. Max. volt. deviation is ±3.5%.	<b>Shock (IEC 60068-2-27)</b>	<u>Operating:</u> Half-sine shock waveform. Impact Acceleration: 20g, Pulse duration: 11mS. Cycles: 3 times per axis in X,Y, Z direction <u>Non-Operating:</u> Half-sine shock waveform. Impact Acceleration: 100g, Pulse duration: 6mS Cycles: 3 times per direction on 3 axes (X,Y, Z)
<b>Ripple and Noise</b>	0.5% pk-pk	<b>Vibration (IEC 60068-2-6) (IEC 60068-2-64)</b>	<u>Operating:</u> Sinusoidal Frequency: 10-500Hz, Impact Acceleration: 1g, Sweep rate: 1 octave/min Cycles: 10 times per axis in X, Y, Z direction <u>Random Vibration:</u> <u>Operating:</u> 0.003g <sup>2</sup> /Hz, 1.224grms overall, 3 axes, 10 min per axis, 1-500Hz. <u>Non-Operating:</u> 0.02g <sup>2</sup> /Hz, 3.1grms overall, 3 axes, 1 hour per axis, 20-500 Hz
<b>Output Voltage</b>	12V to 48Vdc. See models chart for part numbering.	<b>MTBF</b>	564,500 hours (ave) @ 110Vac, 25°C, SR332 Issue 6. Consult Factory @ 220Vac, 25°C, SR332 Issue 6.
<b>Voltage Adjustability</b>	+/- 10%, 48V is +/- 5%	<b>E-Cap Life</b>	>10 Years in use condition of 40°C ambient, at 12h/day, 261 days/year. Additional information on other use profiles available on request.

## General Specifications (Continued)

<b>Overshoot</b>	<2% overshoot at turn-on, <1% overshoot at turn-off, under all conditions.	<b>IPC 610</b>	Class 2
<b>HF Common Mode Noise</b>	0.8 Vrms maximum (input class I)	<b>Safety Standards</b>	IEC 60601-1, 3 <sup>rd</sup> Edition ANSI/AAMI ES60601-1 (2008) CAN/CSA – C22.2 No 60601-1 (2005) DEMKO EN60601-1:2006 Designed to meet China Safety Doc. No. GB4943.1-2011 at 5Km, Tropical Standard at 40°C, 93% RH at 120 hours.
<b>Total Regulation</b>	±1.0 % for all models.	<b>Weight</b>	140g, typical
<b>Minimum Load</b>	Not required.	<b>Dimensions</b>	W: 2.0" x L: 3.5" x H: 1.3" W: 50.8mm x L: 88.9mm x H: 33.02mm

## Additional Outputs

<b>DC OK:</b>	During normal operation, this signal is logic HIGH. Signal will go LOW for output less than 80% (typical) of nominal. Green LED will light on PCB top side during normal operation.	<b>PSU Temperature</b>	Provides resistive value indicating internal temperature of power supply. See Temp Sensor Conversion Table below.
---------------	---	------------------------	---

## EMI/EMC Compliance

<b>Conducted Emissions</b>	<u>EN55011/22</u> : Class B, FCC Part 15. Class B: 6db margin typ, <b>Class 1</b> PSU configuration <u>EN55011/ 22</u> : Class B, FCC Part 15. Class B: 2db margin typ, <b>Class 2</b> PSU configuration
<b>Radiated Emissions</b>	<u>EN55011/22</u> : Class B, FCC Part 15. Class B: 3db margin typ, <b>Class 1</b> PSU configuration. <u>EN55011/22</u> : Class B, FCC Part 15. Class B: 3db margin typ, <b>Class 2</b> PSU configuration.
<b>Harmonic Current Emissions</b>	<u>IEC61000-3-2</u> : Class A
<b>Voltage Fluctuations &amp; Flicker</b>	<u>IEC 61000-3-3</u>
<b>Electro Static Discharge Immunity</b>	<u>IEC61000-4-2</u> : Level 4, 8kV Contact Discharge, 15kV air discharge, Criteria A. Also meets proposed IEC60601-1-2, 4 <sup>th</sup> edition, Table 4
<b>Radiated RF EM Fields Susceptibility</b>	<u>IEC61000-4-3</u> : Level 3, 10V/m, Criteria A. 80MHz-1000 MHz and 3V/m 1.4Ghz to 2.7 GHz. 80% AM at 1kHz. Also meets proposed IEC60601-1-2, 4 <sup>th</sup> edition, Table 4
<b>Proximity Fields from RF wireless communications Equipment</b>	[ <u>IEC60601-1-2</u> : 4 <sup>th</sup> edition, Table 4]
<b>Rated Power Frequency magnetic fields</b>	<u>IEC61000-4-8</u> : Level 5, 30A/m, 50/60 Hz
<b>Low Frequency magnetic fields</b>	[TBD]
<b>Electrical Fast Transients /Bursts</b>	<u>IEC61000-4-4</u> : Level 3, 2KV, 100Khz rep rate, 40A (PS Output), Criteria A <u>IEC61000-4-4</u> : Level 3, 1kV, 20A, (Other Outputs), Criteria B Also meets proposed IEC60601-1-2, 4th edition standard, Table 5 & 6.
<b>Surges Line to Line (DM) and Line to Ground (CM)</b>	<u>IEC61000-4-5</u> : Level 3, +/-1kV DM, +/-2kV CM, Criteria A Also meets proposed IEC60601-1-2, 4th edition standard, Table 5.
<b>Conducted Disturbances induced by RF Fields</b>	<u>IEC61000-4-6</u> : 3V/m & 10 V/m – 0.15 to 80Mhz and 10V/m in ISM and amateur radio bands between 0.15 MHz and 80 MHz, 80% AM at 1 KHz Also meets proposed IEC60601-1-2, 4th edition standard, Table 5 & 6 & 8.
<b>Rated Power Frequency Magnetic Fields Test</b>	<u>IEC61000-4-8</u> : Level 4 (30A/m), Criteria A Also meets proposed IEC60601-1-2, 4 <sup>th</sup> edition standard, Table 4 enclosure port.
<b>Voltage Dips</b>	<u>IEC61000-4-11</u> : 100% dip for 10mS, at 0°, 45°, 90°, 135°, 180°, 225°, 270° and 315°, Criteria A; 60% dip for 100mS, Criteria B; 30% dip for 500mS (25/30 cycles) 1Ø, and 0° for 500mS, Criteria A. Also meets proposed IEC60601-1-2, 4 <sup>th</sup> edition standard, Table 5.
<b>Enclosure Port Immunity to RF wireless communications equipment</b>	<u>IEC61000-4-3</u>

**Notes:** Performance criteria are based on definitions contained in EN55024. Performance criteria are:

A – Normal performance during and after the test, B – Temporary degradation, self-recoverable, C – Temporary degradation, operator intervention required to recover the operation, D – Permanent damage may occur

## Isolation Specifications

Parameter	Conditions/Description	Min	Nom	Max	Units
Insulation Safety Rating	Input/Ground		1 MOPP		
	Input/Output		2 MOPP		
	Output/Ground		1 MOPP		
Electric Strength Test Voltage	Input/Ground	1900			Vac
	Input/Output	4500	-	-	Vac
	Output/Ground	1900			Vac

## Mechanical Drawing

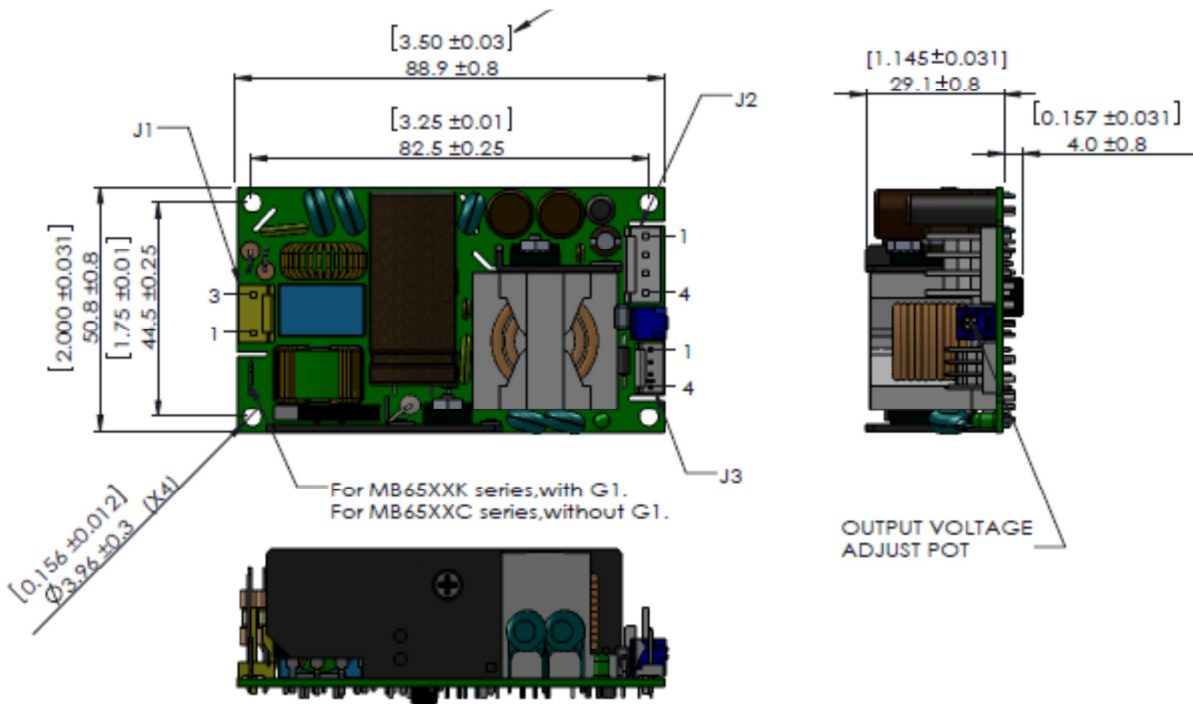

## Connector Information

Input Connector J1	DC Output Connector J2	Ground Connector G1	Signal Connector J3
PIN 1) AC Line PIN 2) Empty (removed) PIN 3) AC Neutral	Pin 1) (+V1) Pin 2) (+V1) Pin 3) (RTN) Pin 4) (RTN)	FG 0.187" Quick-connect tab	PIN 1) RTN PIN 2) DC_OK Pin 3) TEMP SENSOR (+) Pin 4) TEMP SENSOR (-)
<u>Mating Connector:</u>	<u>Mating Connector:</u>	<u>Mating Connector:</u>	<u>Mating Connector:</u>
Tyco/AMP 640250-3 Pins: 640252-2	Tyco/AMP 640250-4 Pins: 640252-2	Molex 01-90020005	Tyco/AMP 1375820-4 Pins: 1375819

### 1.DC-OK signal (J-3):

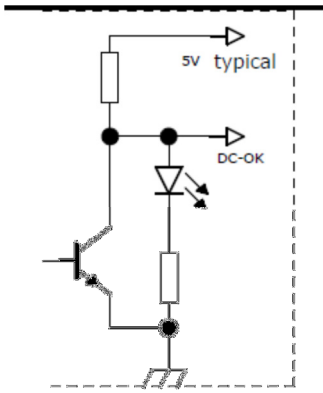

During normal operation, this signal is logic HIGH for output more than 85% (typical) of normal. Signal will go LOW for output less than 80% (typical) of normal. Green LED will light on PCB top side during normal operation.

### 2. Temperature sensor signal (J-3):

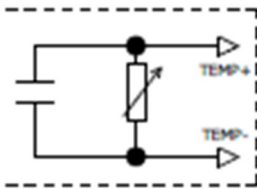

#### Internal Temperature Sensor Conversion Table

Resistance Value across connector J3, pins 3-4	Internal Temperature
6,040K ohms	-20°C
3,227K ohms	-10°C
1,788K ohms	0°C
1,025K ohms	10°C
605.1K ohms	20°C
367.6K ohms	30°C
229.2K ohms	40°C
146.4K ohms	50°C
95.62K ohms	60°C
63.80K ohms	70°C
43.40K ohms	80°C
30.07K ohms	90°C
21.19K ohms	100°C

**Notes:** 1) Tolerances: -20°C to 60°C: +/- 4°C; 70°C to 80°C: +/- 5°C; 90°C to 100°C: +/- 6°C.

### 3. Timing Sequence

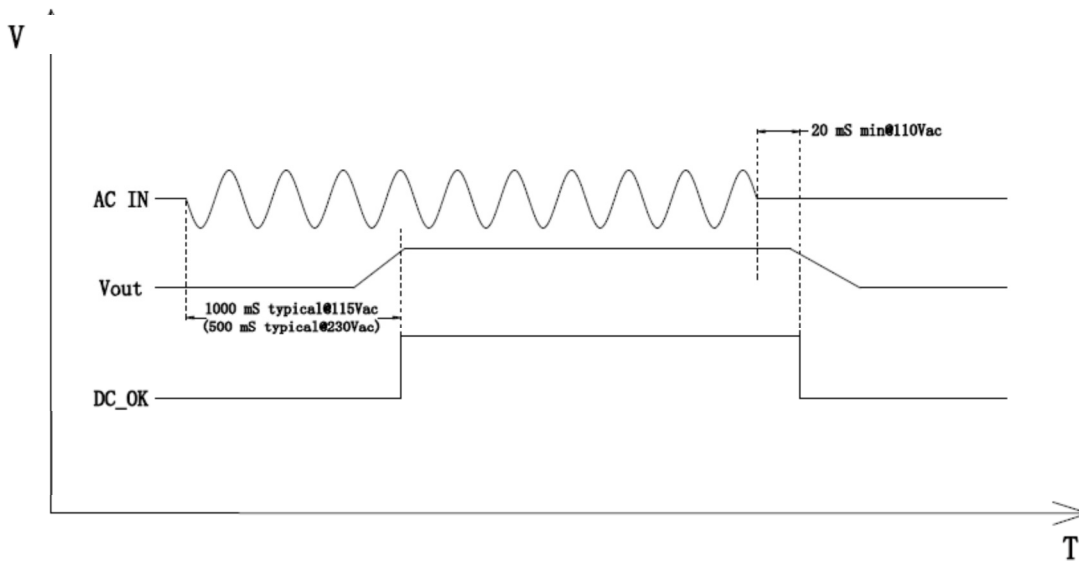

### 4. Protection

All specifications apply over specified input voltage, output load, and temperature range, unless otherwise noted.

Parameter	Conditions/Description	Min	Nom	Max	Units
Input Fuses	Not user accessible				
Input Transient Protection	2KV(CM) and 1KV(DM) surge			2	KV (CM)
Output	No-load and short circuit proof			Hiccup	
	short circuit proof			Hiccup	
	overload			Hiccup	
Oversvoltage Protection	Latch style			Latch	
Over temperature Protection	Automatic power shutdown at TA = 80 °C(typical)				

### 5. Inrush Current, peak ( $I^2T$ rating)

Measured at 264Vac, 50°C at 100% loading, 70°C at de-rated load condition

Model	50°C - $I^2T$ rating (A <sup>2</sup> Seconds, Typical)	70°C - $I^2T$ rating (A <sup>2</sup> Seconds, Typical)
12V Model	8.5	11.0
15V Model	6.5	13.2
24V Model	10.9	12.2
48V Model	10.4	11.1

## 6. Characteristic Curves

### 6.1 Output vs. Temperature

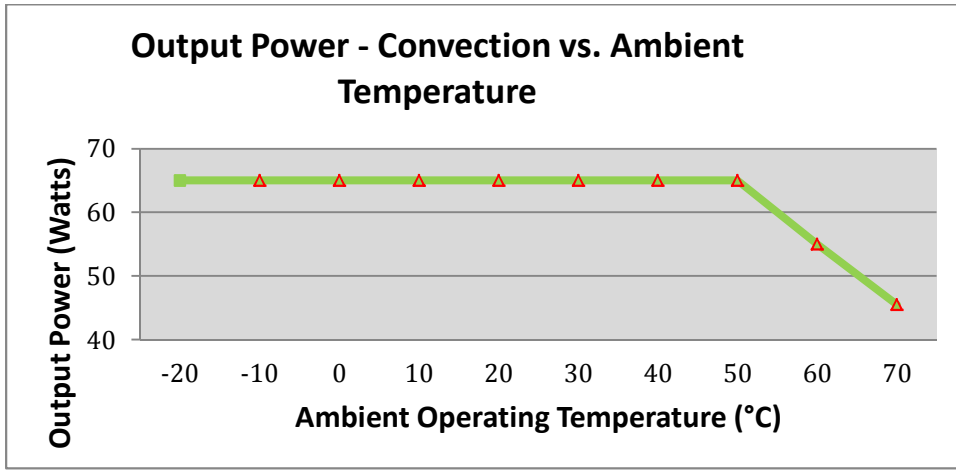

65W convection cooled at -20°C to 50°C operating ambient temperature. De-rated output power to 45.5W at 70°C.

### 6.2 Efficiency vs. Loading at AC Input Voltages

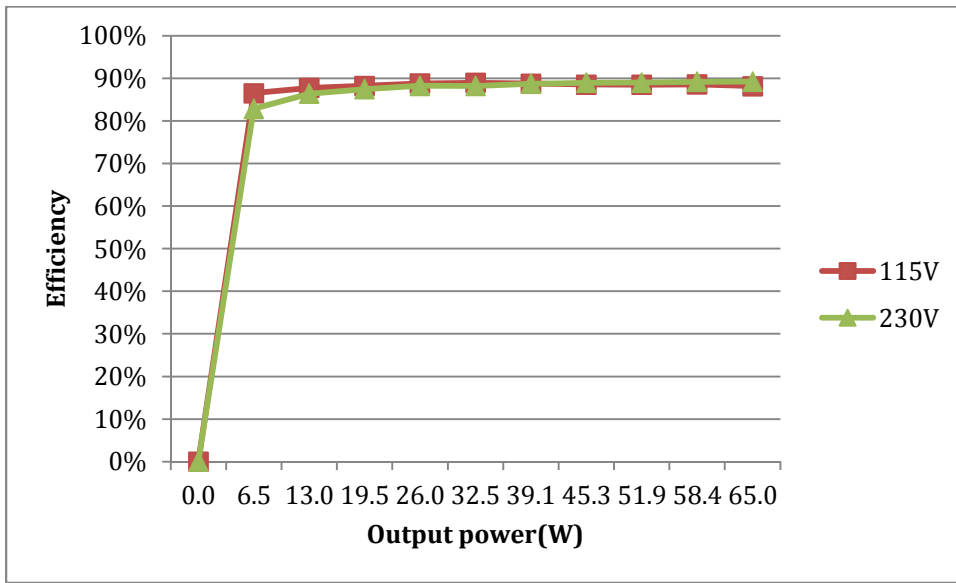

High efficiency is achieved by using QR technology. Synchronous MOSFETs or ultra-fast diodes are used as rectifiers in MB65S family.

### 6.3 Efficiency vs. Loading

The charts below detail the MB65 efficiency vs input voltage and output loading conditions at 25°C, 50°C and 70°C under de-rated power.

**25°C ambient**

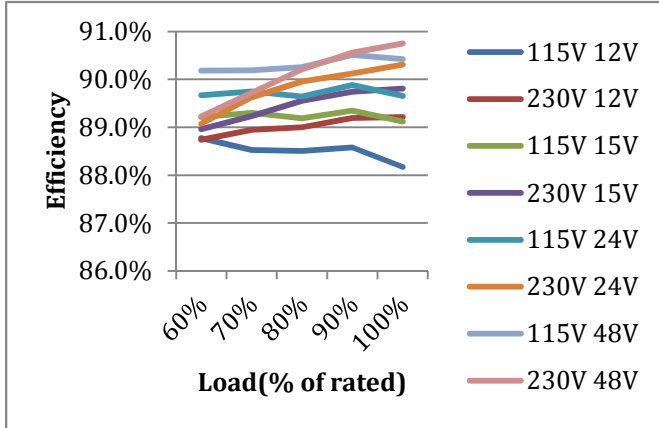

**50°C Ambient**

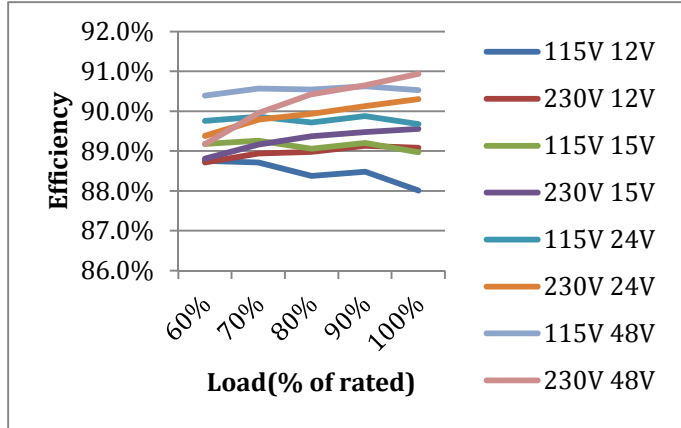

**70°C**

**Ambient**

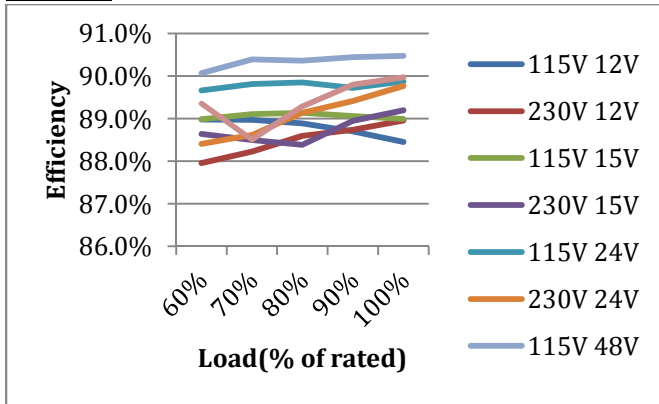

### 6.4 Ripple & Noise

Measured using a scope probe socket with 0.1µF ceramic and a 10µF electrolytic capacitor connected in parallel across it. Bandwidth limit is 20MHz.

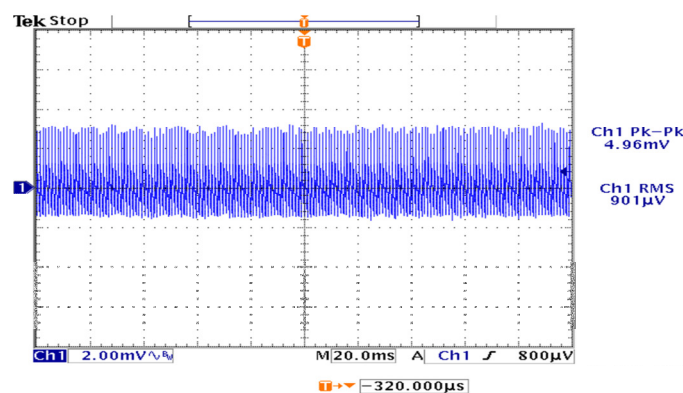

12V OUT, NO LOAD, 85VAC, 60HZ

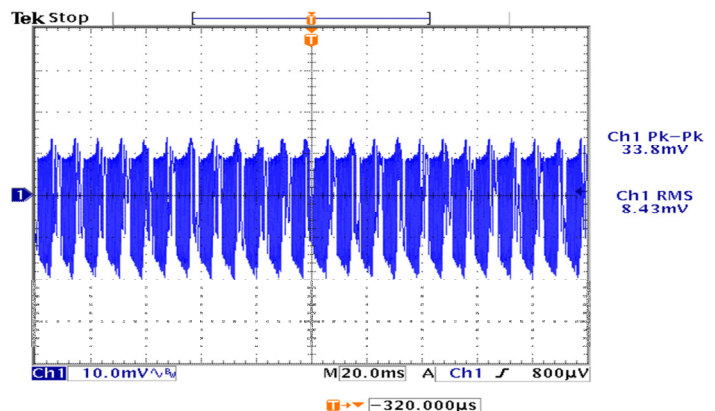

12V OUT, FULL LOAD, 85VAC, 60HZ



### 6.4 Ripple & Noise (Cont'd)

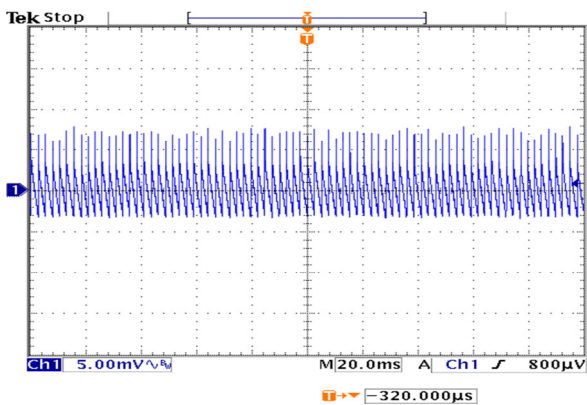

12V OUT, NO LOAD, 264VAC, 50HZ

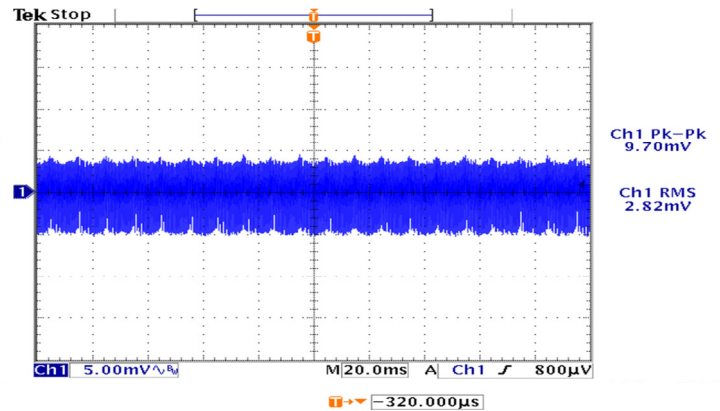

12V OUT, FULL LOAD, 264VAC, 50HZ

### 6.5 Output Transient Response

50% load step within the regulation limits of minimum and maximum load,  $di/dt < 0.2A/\mu\text{Sec}$ . Recovery time not specified as there are no lapse in regulation with a 50% Load Step. Maximum voltage deviation is 3.5%

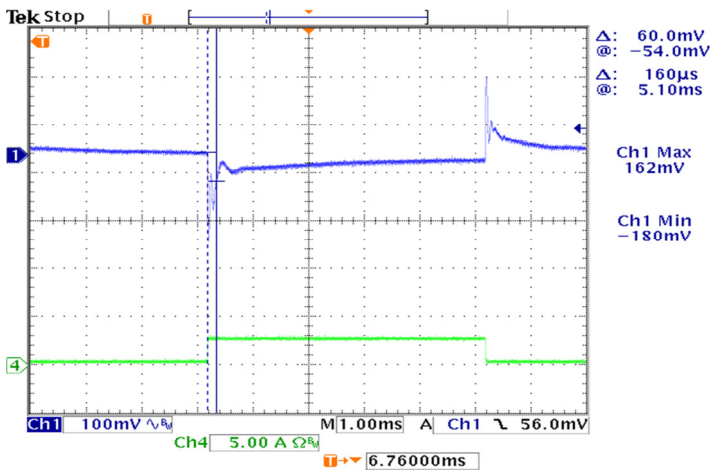

5%~50% Load Transient (AC) at 25°C@115V

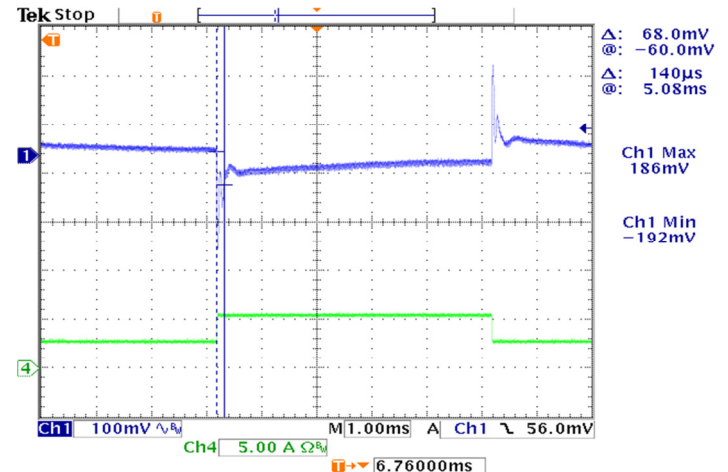

50%~100% Load Transient(AC) at 25°C@115V

## 6.6 Output Overload Characteristic

Supply protects itself against overload conditions. The Power Supply recovers from Overload Conditions without operator intervention.

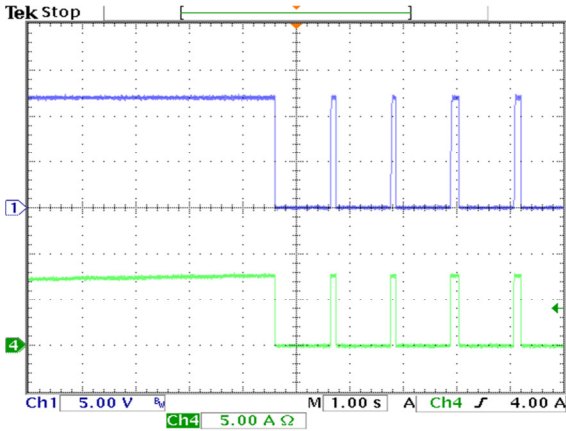

12v out, 100Vac

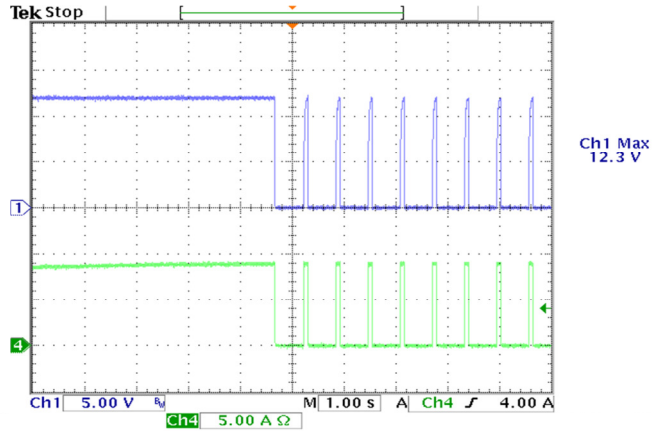

12V out, 240Vac

## 6.7 Turn-On Time

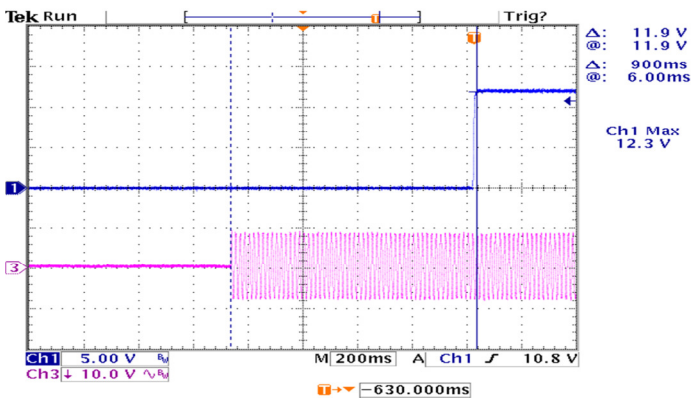

12v out, FULL Load, 115Vac

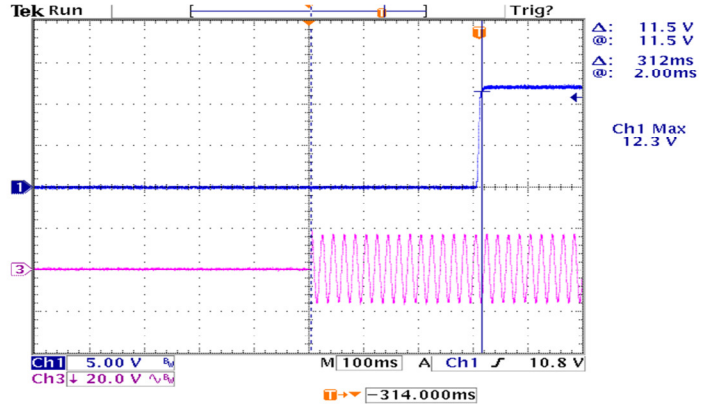

12V out, Full Load, 230Vac

Data Sheet © 2014 SL Power Electronics Corp. The information and specifications contained herein are believed to be correct at the time of publication. However, SL Power accepts no responsibility for consequences arising from reproduction errors or inaccuracies. Specifications are subject to change without notice.

## X-ON Electronics

Largest Supplier of Electrical and Electronic Components

*Click to view similar products for [Switching Power Supplies](#) category:*

*Click to view products by [SI Power](#) manufacturer:*

Other Similar products are found below :

[70841011](#) [73-551-0005](#) [AAD600S-4-OP](#) [R22095](#) [HWS50A-5/RA](#) [KD0204](#) [9021](#) [S-15F-12](#) [LDIN100150](#) [LPM000-BBAR-01](#) [LPX17S-C](#)  
[EVS57-10R6/R](#) [FDC40-24S12](#) [FRV7000G](#) [22929](#) [CQM1IA121](#) [40370121900](#) [VI-PU22-EXX](#) [40370121910](#) [LDIN5075](#) [432703037161](#)  
[WRB01X-U](#) [LPX140-C](#) [08-30466-1040G](#) [09-160CFG](#) [70841004](#) [70841025](#) [VPX3000-CBL-DC](#) [LPM000-BBAR-05](#) [LPM000-BBAR-08](#)  
[LPM124-OUTA1-48](#) [LPM000-BBAR-07](#) [LPM109-OUTA1-10](#) [LPM616-CHAS](#) [08-30466-1055G](#) [08-30466-2175G](#) [DMB-EWG](#) [TVQF-](#)  
[1219-18S](#) [6504-226-2101](#) [CQM1IPS01](#) [XPFM201A+](#) [MAP80-4000G](#) [LFP300F-24-TY](#) [SMP21-L20-DC24V-5A](#) [VI-MUL-ES](#) [08-30466-](#)  
[0065G](#) [CME240P-24](#) [VI-RU031-EWWX](#) [08-30466-0028G](#) [S82Y-TS01](#)