

SS32AF THRU SS320AF SCHOTTKY RECTIFIER

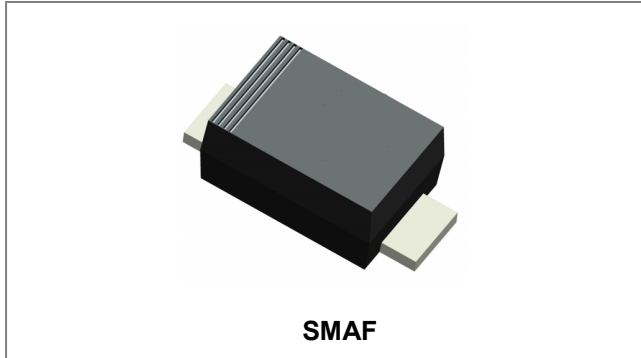

Features

- Schottky Barrier Rectifier
- Guard Ring Die Protection
- Low Forward Voltage
- Reverse Energy Tested
- High Current Capability
- Case Material: Molded Plastic. UL Flammability Classification Rating 94V-0
- This is a Halogen Free device
- All SMC parts are traceable to the wafer lot
- Additional testing can be offered upon request

Circuit Diagram



Mechanical Data

- Case: JEDEC SMAF molded plastic body
- Terminals: leads solderable per MIL-STD-750, Method 2026
- Polarity: Color band denotes cathode end
- Weight: 0.038 grams
- Mounting Position: Any

Maximum Ratings and Electrical Characteristics @T_A=25°C unless otherwise specified

Characteristic	Symbol	SS32 AF	SS33 AF	SS35 AF	SS36 AF	SS38 AF	SS310 AF	SS315 AF	SS320 AF	Units
Maximum Repetitive Peak Reverse Voltage Maximum DC Blocking Voltage	V _{RRM} V _{DC}	20	30	50	60	80	100	150	200	V
Maximum RMS Voltage	V _{RMS}	14	21	35	42	56	70	105	150	V
Maximum Average Forward Rectified Current at T _L (see fig.1)	I _{F(AV)}	3.0								A
Peak Forward Surge Current 8.3ms Single Half Sine-wave Superimposed on Rated Load (JEDEC Method)	I _{FSM}	70								A
Maximum Instantaneous Forward Voltage @ I _F = 3.0A, T _J = 25°C	V _F	0.55	0.70	0.85				0.95	V	
Maximum DC Reverse Current @T _J = 25°C At Rated DC Blocking Voltage @T _J = 100°C	I _R	0.5				0.1				mA
		20				10	2.0			
Typical Junction Capacitance(Note 1)	C _J	500			300				pF	
Typical Thermal Resistance Junction to Ambient(Note 2)	R _{θJA}	80								°C/W
Operating Temperature Range	T _J	-55 to +125				-55 to +150				°C
Storage Temperature Range	T _{STG}	-55 to +150								°C

Note: 1. Measured at 1MHz and applied reverse voltage of 4.0V D.C.
2. P.C.B. mounted with 0.2x0.2"(5.0x5.0mm) copper pad areas

Ratings and Characteristics Curves

FIG.1-FORWARD CURRENT DERATING CURVE

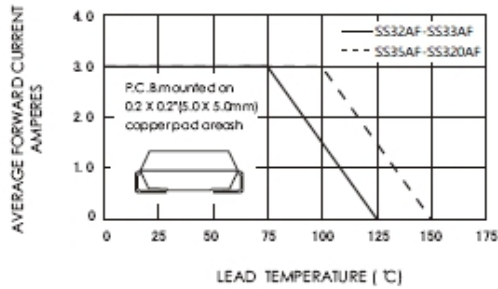

FIG.2-MAXIMUM NON-REPETITIVE PEAK FORWARD SURGE CURRENT

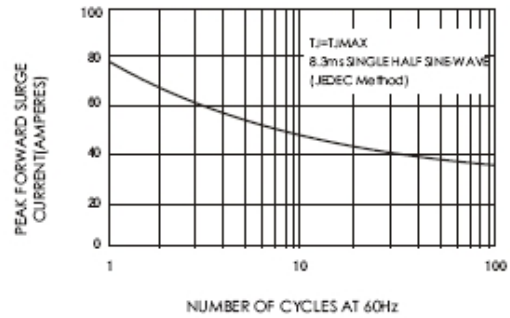

FIG.3-TYPICAL INSTANTANEOUS FORWARD CHARACTERISTICS

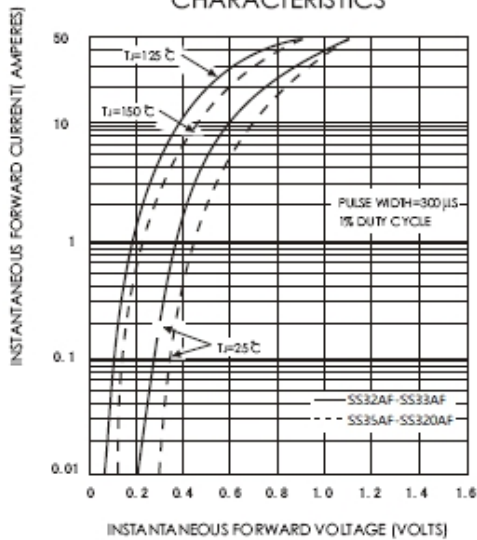

FIG.4-TYPICAL REVERSE CHARACTERISTICS

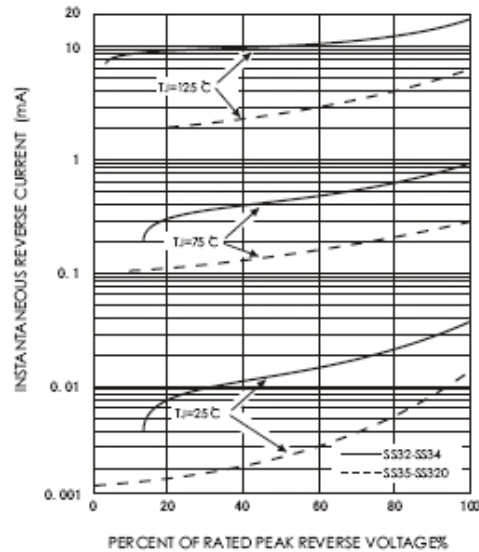

FIG.5-TYPICAL JUNCTION CAPACITANCE

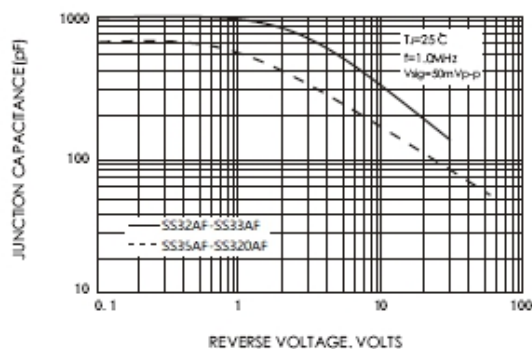
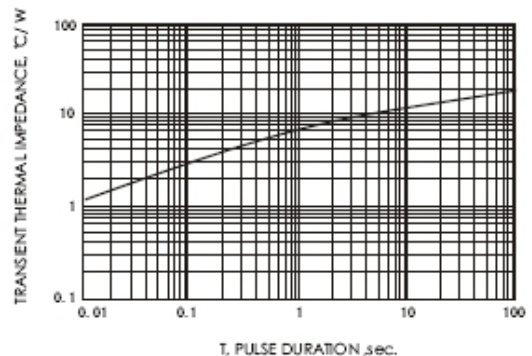
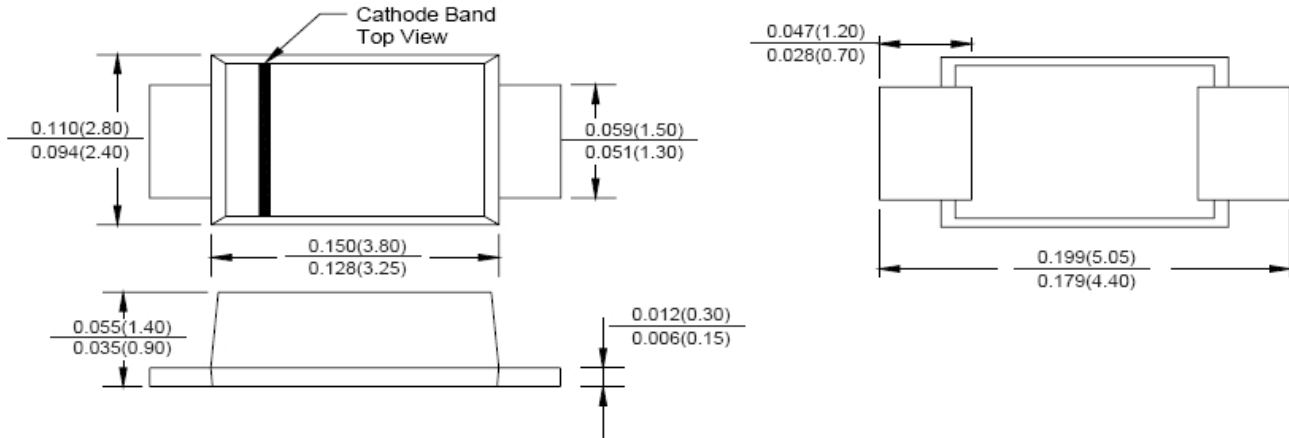

FIG.6-TYPICAL TRANSIENT THERMAL IMPEDANCE



Mechanical Dimensions SMAF (Millimeters/Inches)



Ordering Information

Device	Package	Shipping
SS32AF THRU SS320AF	SMAF	3000pcs / reel
SS32AFTR THRU SS320AFTR	SMAF	3000pcs / reel

For information on tape and reel specifications, including part orientation and tape sizes, please refer to our tape and reel packaging specification.

Marking Diagram

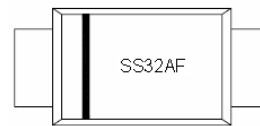

Where XXXXX is YYWWL
YYWWL date code marked on box.

SS32AF = Part Name
YY = Year
WW = Week
L = Lot Number

Carrier Tape Specification SMAF

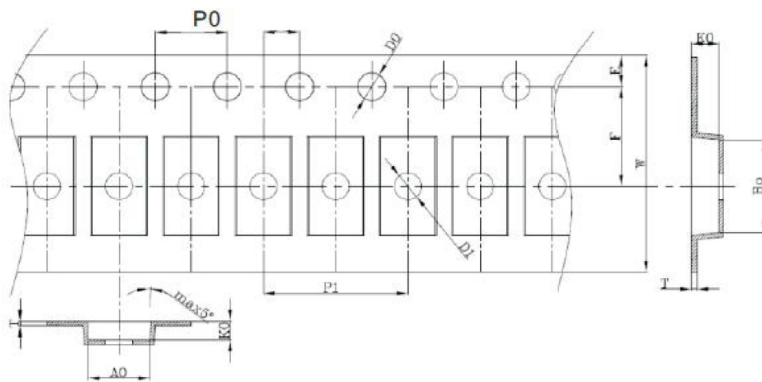

SYMBOL	Millimeters	
	Min.	Max.
A0	2.83	3.03
B0	2.23	5.43
K0	1.23	1.43
P0	3.90	4.10
P1	3.90	4.10
P2	1.90	2.10
T	0.17	0.23
E	1.63	1.83
F	5.45	5.65
D0	1.50	1.60
D1	1.45	1.55
W	11.70	12.30



**SS32AF
THRU
SS320AF**

**Technical Data
Data Sheet N1949, Rev. A**



DISCLAIMER:

- 1- The information given herein, including the specifications and dimensions, is subject to change without prior notice to improve product characteristics. Before ordering, purchasers are advised to contact the SMC Diode Solutions sales department for the latest version of the datasheet(s).
- 2- In cases where extremely high reliability is required (such as use in nuclear power control, aerospace and aviation, traffic equipment, medical equipment, and safety equipment), safety should be ensured by using semiconductor devices that feature assured safety or by means of users' fail-safe precautions or other arrangement.
- 3- In no event shall SMC Diode Solutions be liable for any damages that may result from an accident or any other cause during operation of the user's units according to the datasheet(s). SMC Diode Solution assumes no responsibility for any intellectual property claims or any other problems that may result from applications of information, products or circuits described in the datasheets.
- 4- In no event shall SMC Diode Solutions be liable for any failure in a semiconductor device or any secondary damage resulting from use at a value exceeding the absolute maximum rating.
- 5- No license is granted by the datasheet(s) under any patents or other rights of any third party or SMC Diode Solutions.
- 6- The datasheet(s) may not be reproduced or duplicated, in any form, in whole or part, without the expressed written permission of SMC Diode Solutions.
- 7- The products (technologies) described in the datasheet(s) are not to be provided to any party whose purpose in their application will hinder maintenance of international peace and safety nor are they to be applied to that purpose by their direct purchasers or any third party. When exporting these products (technologies), the necessary procedures are to be taken in accordance with related laws and regulations..

X-ON Electronics

Largest Supplier of Electrical and Electronic Components

Click to view similar products for [Schottky Diodes & Rectifiers](#) category:

Click to view products by [SMC Diode](#) manufacturer:

Other Similar products are found below :

[MA4E2039](#) [MA4E2508M-1112](#) [MBR0530L-TP](#) [MBR10100CT-BP](#) [MBR1545CT](#) [MMBD301M3T5G](#) [RB160M-50TR](#)

[BAS16E6433HTMA1](#) [BAS 3010S-02LRH E6327](#) [BAT 54-02LRH E6327](#) [IDL02G65C5XUMA1](#) [NSR05F40QNXT5G](#) [NSVR05F40NXT5G](#)

[NTE555](#) [JANS1N6640](#) [SB07-03C-TB-H](#) [SK310-T](#) [SK33A-TP](#) [SK34B-TP](#) [SS3003CH-TL-E](#) [PDS3100Q-7](#) [GA01SHT18](#)

[CRS10I30A\(TE85L,QM](#) [MA4E2501L-1290](#) [MBRB30H30CT-1G](#) [JANTX1N5712-1](#) [SB007-03C-TB-E](#) [SK33B-TP](#) [SK35A-TP](#) [SK38B-LTP](#)

[NTE505](#) [NTSB30U100CT-1G](#) [VS-6CWQ10FNHM3](#) [CRG04\(T5L,TEMQ\)](#) [ACDBA1100LR-HF](#) [ACDBA1200-HF](#) [ACDBA240-HF](#)

[ACDBA3100-HF](#) [CDBQC0530L-HF](#) [ACDBA260LR-HF](#) [ACDBA1100-HF](#) [MA4E2502L-1246](#) [10BQ015-M3/5BT](#) [10BQ060-M3/5BT](#)

[NRVB130LSFT1G](#) [CRS08TE85LQM](#) [PMAD1108-LF](#) [B120Q-13-F](#) [1N5819T-G](#) [B0530WSQ-7-F](#)