

# M23 Stainless Steel

## Series L & Series S

Environmentally Sealed Circular Connectors



# Hypertac<sup>®</sup> Hyperboloid Technology

Smiths Interconnect offers an extensive range of superior contact technologies suitable for standard and custom solutions. Hypertac<sup>®</sup> (HYPERboloid conTACT) is the original superior performing hyperboloid contact technology designed for use in all applications and in harsh and demanding environments where high reliability and safety are critical. The inherent electrical and mechanical characteristics of the Hypertac hyperboloid contact ensures unrivalled performance in terms of reliability, number of mating cycles, low contact force and minimal contact resistance. The shape of the contact sleeve is formed by hyperbolically arranged contact wires, which align themselves elastically as contact lines around the pin, providing a number of linear contact paths.

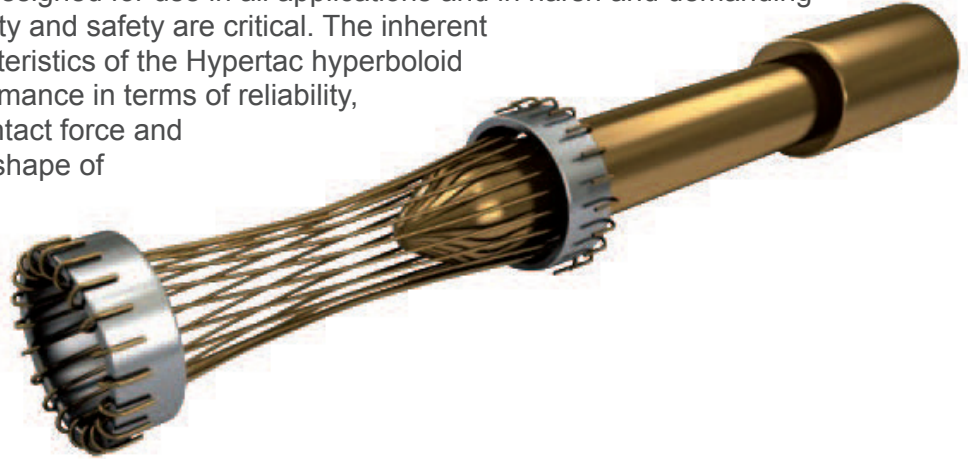

Features	Benefits
<p><b>Low insertion/extraction forces</b></p> <p>The angle of the socket wires allows tight control of the pin insertion and extraction forces. The spring wires are smoothly deflected to make line contact with the pin.</p>	<p><b>High density interconnect systems</b></p> <p>Significant reductions in size and weight of sub-system designs. No additional hardware is required to overcome mating and un-mating forces.</p>
<p><b>Long contact life</b></p> <p>The smooth and light wiping action minimizes wear on the contact surfaces. Contacts perform up to 100,000 insertion/extraction cycles with minimal degradation in performance.</p>	<p><b>Low cost of ownership</b></p> <p>The Hypertac contact technology will surpass most product requirements, thus eliminating the burden and cost of having to replace the connector or the entire subsystem.</p>
<p><b>Lower contact resistance</b></p> <p>The design provides a far greater contact area and the wiping action of the wires insures a clean and polished contact surface. Our contact technology has about half the resistance of conventional contact designs.</p>	<p><b>Low power consumption</b></p> <p>The lower contact resistance of our technology results in a lower voltage drop across the connector reducing the power consumption and heat generation within the system.</p>
<p><b>Higher current ratings</b></p> <p>The design parameters of the contact (e.g., the number, diameter and angle of the wires) may be modified for any requirement. The number of wires can be increased so the contact area is distributed over a larger surface. Thus, the high current carried by each wire because of its intimate line contact, can be multiplied many times.</p>	<p><b>Maximum contact performance</b></p> <p>The lower contact resistance of the Hypertac contact reduces heat build-up; therefore Hypertac contacts are able to handle far greater current in smaller contact assemblies without the detrimental effects of high temperature.</p>
<p><b>Immunity to shock &amp; vibration</b></p> <p>The low mass and resultant low inertia of the wires enable them to follow the most abrupt or extreme excursions of the pin without loss of contact. The contact area extends 360° around the pin and is uniform over its entire length. The 3 dimensional symmetry of the Hypertac contact design guarantees electrical continuity in all circumstances.</p>	<p><b>Reliability under harsh environments</b></p> <p>Harsh environmental conditions require connectors that will sustain their electrical integrity even under the most demanding conditions such as shock and vibration. The Hypertac contact provides unmatched stability in demanding environments when failure is not an option.</p>

# Contents

<b>M23 STAINLESS STEEL</b> .....	<b>2</b>
<b>M23 POWER CONNECTORS SERIES L</b> .....	<b>3</b>
Type Overview .....	3
Technical Characteristics .....	4
How to Order .....	5
Available Connectors:	
Receptacles .....	6 - 7
Extensions .....	8
Plugs .....	9
Panel Feed Through .....	10 - 11
Contacts	
Machined Pins .....	12
Machined Sockets .....	13
Assembly Instructions .....	14 - 19
<b>M23 SIGNAL CONNECTORS SERIES S</b> .....	<b>21</b>
Type Overview .....	21
Technical Characteristics .....	22
How to Order .....	23
Available Connectors:	
Plugs .....	24 - 25
Extensions .....	26 - 27
Receptacles .....	28 - 31
Contacts	
Machined Pins .....	32
Machined Sockets .....	33
Stamped Pins .....	34
Stamped Sockets .....	35
Assembly Instructions .....	36 - 39
<b>TOOLS</b> .....	<b>40 - 41</b>
<b>CABLE CLAMPS &amp; ASSESSORIES</b> .....	<b>42 - 43</b>

# M23 Stainless Steel

## Environmentally Sealed Connectors



The Smiths Interconnect M23 Stainless Steel series have been specifically developed for applications operating in highly corrosive environments.

Manufactured from high grade stainless steel and advanced polymers, these connectors are ideally suited for use in the Medical, Pharmaceutical, Maritime, Automotive and Food and Beverage Industries. Environmentally sealed to IP67 and chemically resistant to both Lye and Acids, these connectors are protected against the harshest of Industrial processing environments.

In addition to specialist materials, these connectors feature a smooth outer body design to aid industrial wash down processes, by preventing the entrapment of dirt and contaminants. A complete range of options and accessories are available as standard, making this series suitable for a wide range of applications.

Hyperboloid contact technology is ideally suited for use in harsh and demanding environments where high reliability and safety are critical. The electrical and mechanical characteristics of the contact ensure unrivalled performance in terms of reliability, number of mating cycles, low contact forces and electrical stability over time.

These performance characteristics provide a real commercial benefit in terms of the total installed cost of ownership.

Protected against  
the harshest of  
industrial processing  
environments

## Features & Benefits

### Electrical continuity ensuring failure free performance

- Hypertac® contact technology ensures immunity to shock and vibration and minimal contact resistance
- Outstanding protection against electromagnetic interference through a full 360° screen shielding

### Superior performance

- Environmentally sealed
- Corrosion resistant
- Vibration protected

### Easy of Assembly and Use

- Hygienic and compact design
- Minimized number of components, simplified assembly and reduced stocking requirements
- Simplified assembly, high contact retention forces

### UL certified

- UL/CSA approval file No. 178462

# Type Overview

## M23 Stainless Steel Power Connectors Series L

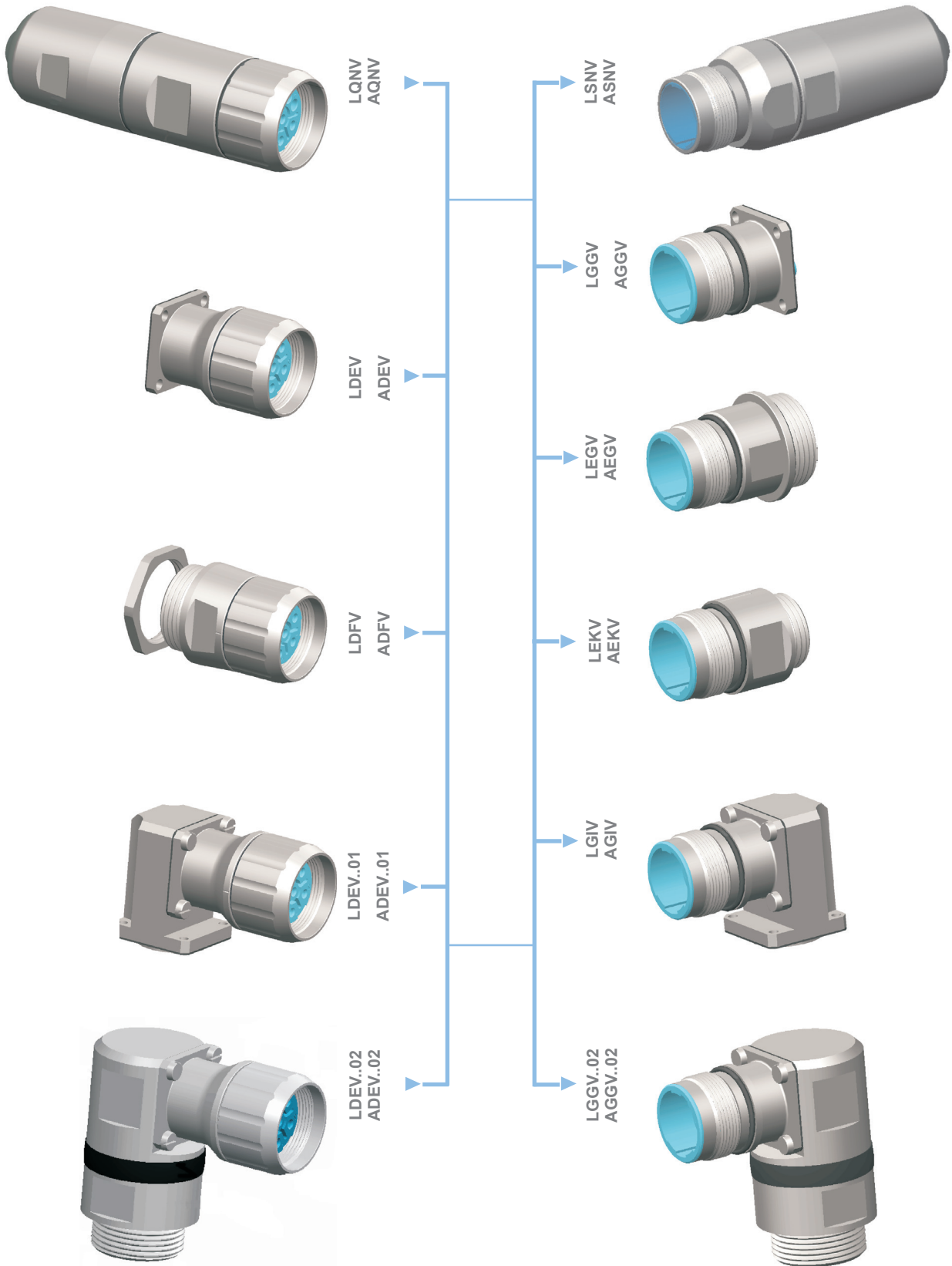

# Technical Characteristics

## M23 Stainless Steel Power Connectors Series L

### Mechanical

### Standards

Contact diameter 6poles	6 x Ø 2mm	-
Contact diameter 8poles	4 x Ø 1mm + 4 x Ø 2mm	-

### Material

Shell	V2A (V4A on demand)	-
Contacts	CuZn alloy	-
Insert	PA, PBT	-
Sealing	FKM, EPDM	-

### Finishes

Shell plating	passivated	-
Contacts plating	Gold over nickel	-

### Electrical

Current rating	9 A (contact Ø 1mm) 8 A (contact Ø 1mm) 7 A (contact Ø 1mm) 22 A (contact Ø 2mm) 20 A (contact Ø 2mm) 14 A (contact Ø 2mm)	EN 61984 USR / UL1977 CNR / UL1977 EN 61984 USR / UL1977 CNR / UL1977
Voltage rating	250 V (contact Ø 1mm) 250 V (contact Ø 1mm) 630 V (contact Ø 2mm) 600 V (contact Ø 2mm)	EN 61984 USR / CNR / UL1977 EN 61984 USR / CNR / UL1977
Withstanding voltage	2500 V (contact Ø 1mm) 6000 V (contact Ø 2mm)	EN 61984 EN 61984
Contact resistance	<5 mΩ (contact Ø 1mm) <3 mΩ (contact Ø 2mm)	EN 61984 EN 61984
Insulation resistance	10 <sup>13</sup> Ωcm	EN 61984
Overvoltage category	III	EN 61984

### Physical and Environmental

Operating temperature range	-40°C ... 125°C -40°C ... 110°C	EN 61984 UL1977
Storage conditions	-40°C ... 70°C/ min. humidity 40%	-
Environmental level	IP67 (mated)	DIN EN 60529
Contamination level	3 (mated)	EN 61984
Installation altitude	up to 2000 m	EN 61984
Fire & Smoke	Recognition file No E 178462	UL 1977
RoHS	Compliant	-

Consult factory for details

# How To Order

## M23 Stainless Steel Power Connectors Series L

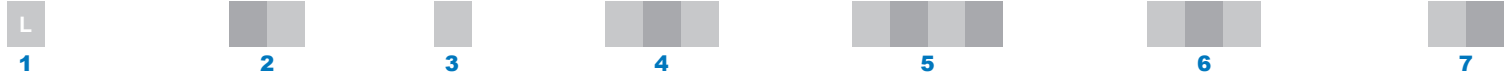

### 1 CONNECTOR FAMILY

**L** M23 stainless steel circular connectors, Series L

### 2 CONNECTOR DESIGN

<b>Q N</b>	plug with variable shield connection and variable cable clamp	<b>G G</b>	straight receptacle with flange
<b>S N</b>	extension with variable shield connection and variable cable clamp	<b>E G</b>	straight receptacle, threaded connection M 25x1.5
<b>D E</b>	panel feed through with square flange	<b>E K</b>	straight receptacle, threaded connection M 20x1.5
<b>D F</b>	panel feed through, threaded connection M 25x1.5	<b>E E</b>	straight receptacle, axial sealing, long version
		<b>G I</b>	angled receptacle with flange

### 3 PLATING

**V** passivated

### 4 INSERTS

<b>0 6 A</b>	6 way for pins 6 x Ø 2mm	<b>0 8 A</b>	8way for pins 4 x Ø 1mm + 4 x Ø 2mm
<b>0 6 B</b>	6way for sockets 6 x Ø 2mm	<b>0 8 B</b>	8way for sockets 4 x Ø 1mm + 4 x Ø 2mm

### 5 TERMINATION STYLE

<b>N N N N</b>	without contacts, loose contacts to be ordered separately	<b>M R C N</b>	including machined pins, 6 x Ø 2mm AWG 20-16
<b>F R B N</b>	including machined sockets, 6 x Ø 2mm AWG 20-16	<b>M R K N</b>	including machined pins, 6 x Ø 2mm AWG 18-14
<b>F R D N</b>	including machined sockets, 6 x Ø 2mm AWG 18-14	<b>M R P N</b>	including machined pins, 6 x Ø 2mm AWG 16-14
<b>F R K B</b>	including machined sockets, 4 x Ø 1mm AWG 24-18 + 4 x Ø 2mm, AWG 20-16	<b>M R E C</b>	including machined pins, 4 x Ø 1mm AWG 24-18 + 4 x Ø 2mm, AWG 20-16
<b>F R K D</b>	including machined sockets, 4 x Ø 1mm AWG 24-18 + 4 x Ø 2mm, AWG 18-14	<b>M R E K</b>	including machined pins, 4 x Ø 1mm AWG 24-18 + 4 x Ø 2mm, AWG 18-14
		<b>M R E P</b>	including machined pins, 4 x Ø 1mm AWG 24-18 + 4 x Ø 2mm, AWG 16-14

### 6 CABLE CLAMPING

<b>0 0 0</b>	without cable clamp for receptacles and panel feed through
<b>1 7 0</b>	variable clamp for cable Ø 7.7mm to 14.5mm can be used for all shielded and non shielded cables
<b>3 0 5</b>	for cable diameter 5 - 9 mm, can be used for shielded and non-shielded cables
<b>3 0 6</b>	for cable diameter 9 - 15 mm, can be used for shielded and non-shielded cables
<b>3 0 7</b>	for cable diameter 16 mm, can be used for shielded and non-shielded cables

### 7 VERSION NUMBER

<b>0 1</b>	depending on type and special design see detailed description of connector design LDEV / ADEV
<b>0 2</b>	depending on type and special design see detailed description of connector design LGGV / AGGV / LDEV / ADEV

# Available Connectors

## Power Receptacles Series L with Crimp Contacts

CONTACT ARRANGEMENTS  
VIEW MATING FACE

LAYOUT  
DESCRIPTION  
PART NUMBER CODE

Straight receptacle, radial sealing to the device, mounting flange

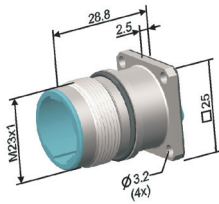

Part number incl. O-ring against vibration on demand

Straight receptacle, axial sealing to the device, connecting thread M25 x 1.5

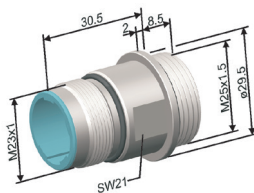

Part number incl. O-ring against vibration on demand

Straight receptacle, axial sealing to the device, connecting thread M20 x 1.5

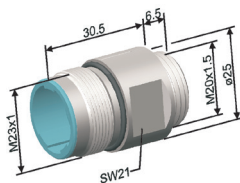

Part number incl. O-ring against vibration on demand

SHELL	INSERT	06A		08A		CABLE CLAMP
		Termination cross section of the pins in mm <sup>2</sup>				
		6 x 0.5 - 1.5	6 x 0.75 - 2.5	4 x 0.24 - 1 4 x 0.5 - 1.5	4 x 0.24 - 1 4 x 0.75 - 2.5	
LGGV AGGV*	06A	MRCN	MRKN			000
	08A			MREC	MREK	
LEGV AEGV*	06A	MRCN	MRKN			000
	08A			MREC	MREK	
LEKV AEKV*	06A	MRCN	MRKN			000
	08A			MREC	MREK	

\* UL-Version



# Power Receptacles Series L with Crimp Contacts

CONTACT ARRANGEMENTS  
VIEW MATING FACE

LAYOUT  
DESCRIPTION  
PART NUMBER CODE

Fixed angled receptacle, radial sealing to the device, mounting flange

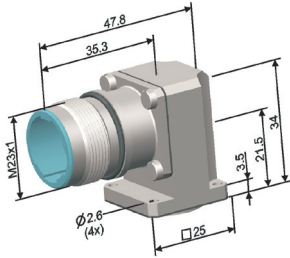

Part number incl. O-ring against vibration on demand

Rotatable receptacle, axial sealing to the device, connecting thread M25 x 1.5

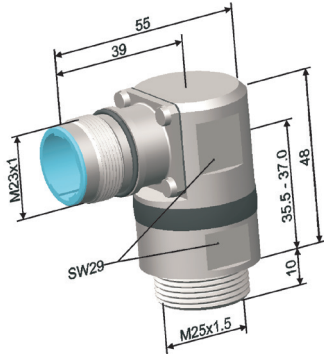

Part number incl. O-ring against vibration on demand

SHELL	INSERT	Termination cross section of the pins in mm²				CABLE CLAMP
		06A		08A		
		6 x 0.5 - 1.5	6 x 0.75 - 2.5	4 x 0.24 - 1 4 x 0.5 - 1.5	4 x 0.24 - 1 4 x 0.75 - 2.5	
LGIV AGIV*	06A	MRCN				000
	08A		MRKN	MREC	MREK	
LGGV AGGV*	06A	MRCN				000 02
	08A		MRKN	MREC	MREK	

\* UL-Version

Drilling drawings

LGGV, LGIV  
AGGV, AGIV

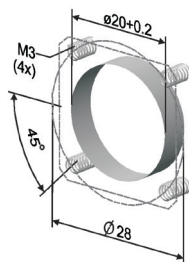

LEKV  
AEKV



LEGV, LGGV..02  
AEGV, AGGV..02

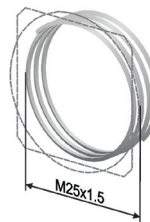

# Power Extensions Series L with Crimp Contacts

CONTACT ARRANGEMENTS  
VIEW MATING FACE

LAYOUT  
DESCRIPTION  
PART NUMBER CODE

Extension with earth connection, variable shield connection and variable cable clamp Ø 7.7 - 14.5 mm

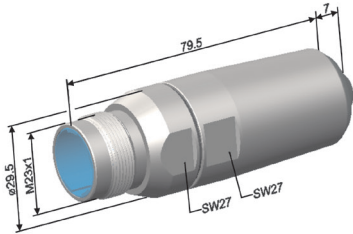

Part number incl. O-ring against vibration on demand

SHELL	INSERT	Termination cross section of the pins in mm <sup>2</sup>		CABLE CLAMP
		06A	08A	
		6 x 1.5 - 2.5	4 x 0.24 - 1 4 x 1.5 - 2.5	
LSNV ASN <sup>V</sup> *	06A	MRPN		170
	08A		MREP	

\* UL-Version

# Power Plugs Series L with Crimp Contacts

CONTACT ARRANGEMENTS  
VIEW MATING FACE

LAYOUT  
DESCRIPTION  
PART NUMBER CODE

Plug with earth connection, variable shield connection and variable cable clamps

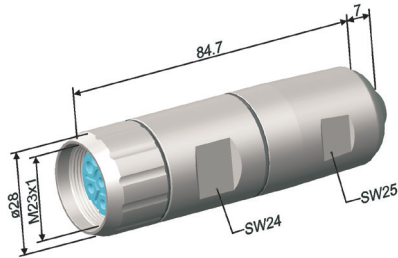

SHELL	INSERT	Termination cross section of the pins in mm <sup>2</sup>				CABLE CLAMP
		6 x 0.5 - 1.5	6 x 0.75 - 2.5	4 x 0.24 - 1 4 x 0.5 - 1.5	4 x 0.24 - 1 4 x 0.75 - 2.5	
		06B	08B			
LQNV AQNV*	06B	FRBN				305 306 307
			FRDN			
	08B			FRKB		
					FRKD	

\* UL-Version

# Power Panel Feed Through Series L with Crimp Contacts

CONTACT ARRANGEMENTS  
VIEW MATING FACE

LAYOUT  
DESCRIPTION  
PART NUMBER CODE

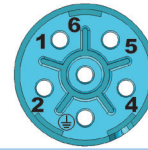

06B

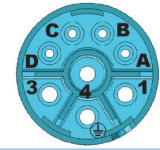

08B

Termination cross section of the pins in mm<sup>2</sup>

6 x 0.5 - 1.5

6 x 0.75 - 2.5

4 x 0.24 - 1  
4 x 0.5 - 1.5

4 x 0.24 - 1  
4 x 0.75 - 2.5

CABLE CLAMP

Straight panel feed through, radial sealing to the device, mounting flange

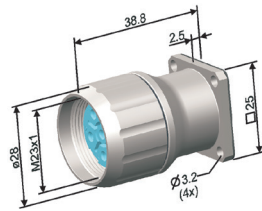

SHELL	INSERT	Termination cross section of the pins in mm <sup>2</sup>				CABLE CLAMP
		6 x 0.5 - 1.5	6 x 0.75 - 2.5	4 x 0.24 - 1 4 x 0.5 - 1.5	4 x 0.24 - 1 4 x 0.75 - 2.5	
LDEV ADEV*	06B	FRBN				000
			FRDN			
08B				FRKB		
					FRKD	
LDFV ADFV*	06B	FRBN				000
			FRDN			
08B				FRKB		
					FRKD	

Straight panel feed through, axial sealing, connecting thread M25x1,5

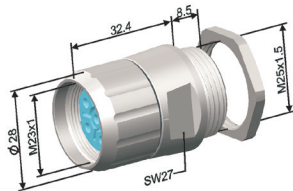

\* UL-Version

# Power Panel Feed Through Series L with Crimp Contacts

CONTACT ARRANGEMENTS  
VIEW MATING FACE

LAYOUT  
DESCRIPTION  
PART NUMBER CODE

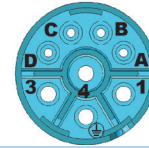
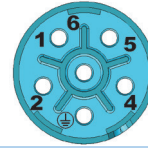

06B

08B

Termination cross section of the pins in mm<sup>2</sup>

SHELL	INSERT	Termination cross section of the pins in mm <sup>2</sup>				CABLE CLAMP
		6 x 0.5 - 1.5	6 x 0.75 - 2.5	4 x 0.24 - 1 4 x 0.5 - 1.5	4 x 0.24 - 1 4 x 0.75 - 2.5	
LDEV ADEV*	06B	FRBN				000 01
			FRDN			
08B				FRKB		000 02
					FRKD	

Angled panel feed through, axial sealing to the device, mounting flange

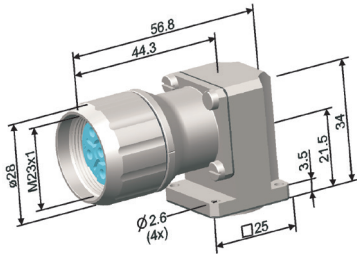

Rotatable angled panel feed through, axial sealing, connecting thread M25x1,5

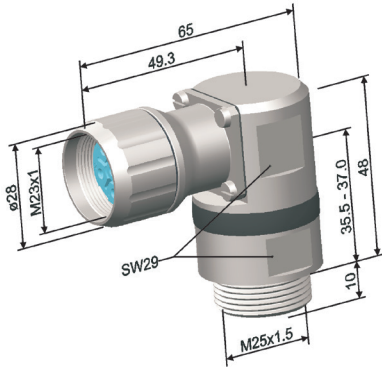

\* UL-Version

Drilling drawings



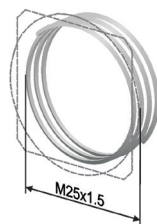
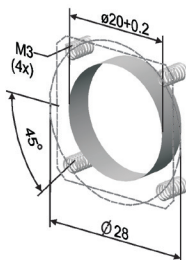

LDEV, LDEV..01  
ADEV, ADEV..01

LDFV, LDEV..02  
ADFV, ADEV..02



# Contacts





## Machined Pins Series L

Type	E	C	K	P
Contact diameter [mm]	1	2	2	2
Part number and layout	021.129.1020 	021.101.2000 	021.147.2000 	021.279.1020 
Termination cross section* [mm <sup>2</sup> ] AWG	0.24 - 1 (24 - 18)	0.5 - 1.5 (20 - 16)	0.75 - 2.5 (18 - 14)	1.5 - 2.5 (16 - 14)
Maximum conductor diameter [mm]	1.3	1.8	2.3	2.3
Maximum insulation diameter [mm]	-	-	-	3.5
For following number of contacts	8	6/8	6/8	6/8

Tooling				
Crimping tool	B151	B151	B151	B151
Positioner	B156	B157	B157	B165
Insertion tool	B118	B117	B117	-
Extraction tool	B038/A	B037/A	B037/A	-

\*Mentioned crimp ranges are recommendations and only valid with flexible wires H05(07)V-K [mm<sup>2</sup>] acc. to DIN VDE 0281/0282 pp and with non compressed standard cables and wires acc. to DIN VDE 0295. It is possible that due to another structure of wires further cross sections and currents can be processed.

## Machined Sockets Series L

Type	K	B	D	H
Contact diameter [mm]	1	2	2	2
Part number and layout				
	020.232.2000 	020.090.1020 	020.105.1020 	020.123.1020 
Termination cross section* [mm <sup>2</sup> ] AWG	0.24 - 1 (24 - 18)	0.5 - 1.5 (20 - 16)	0.75 - 2.5 (18 - 14)	0.75 - 2.5 (18 - 14)
Maximum conductor diameter [mm]	1.3	1.9	2.3	2.3
Maximum insulation diameter [mm]	2.1	-	-	4.5
For following number of contacts	8	6/8	6/8	6

Tooling				
Crimping tool	B151** B150	B151	B151	B151 B152 B179
Positioner	B252** B055/A	B157	B157	B154
Insertion tool	B118	-	-	-
Extraction tool	B056/A	-	-	-

\*Mentioned crimp ranges are recommendations and only valid with flexible wires H05(07)V-K [mm<sup>2</sup>] acc. to DIN VDE 0281/0282 pp and with non compressed standard cables and wires acc. to DIN VDE 0295. It is possible that due to another structure of wires further cross sections and currents can be processed.

\*\*preferred crimping tool

# Assembly instructions

Power receptacle LGGV... LEGV... LEKV... LGIV... LGGV.02

Page 1 of 2

	Stripping Length
	Machined Contacts
A	7 mm

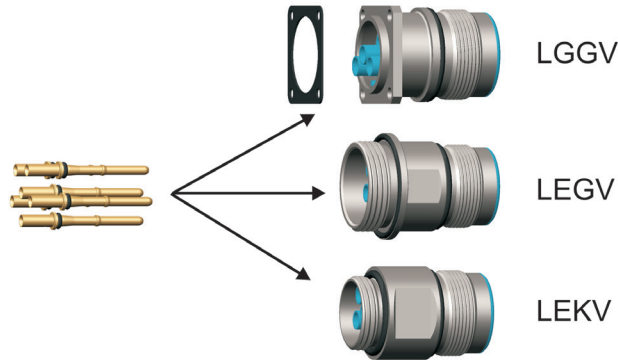

## Assembly

1

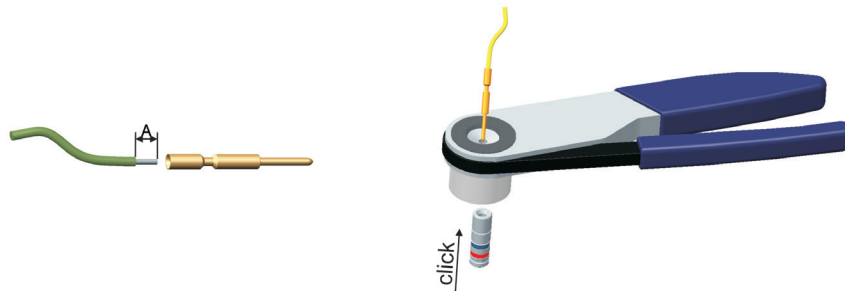

2

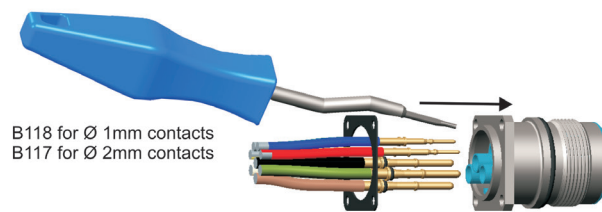

## Dismantling

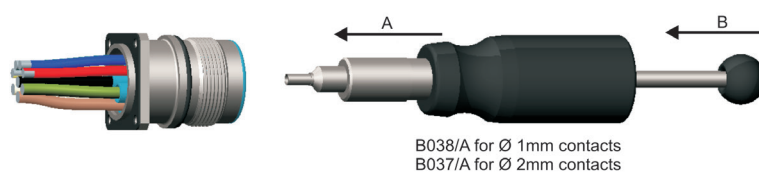

After assembly the connector has to be checked for the functions of the safety precautions (according to EN 60204-1, VDE 0113 Teil 1)



# Assembly instructions

Power receptacle LGGV... LEGV... LEKV... LGIV... LGGV..02

Page 2 of 2

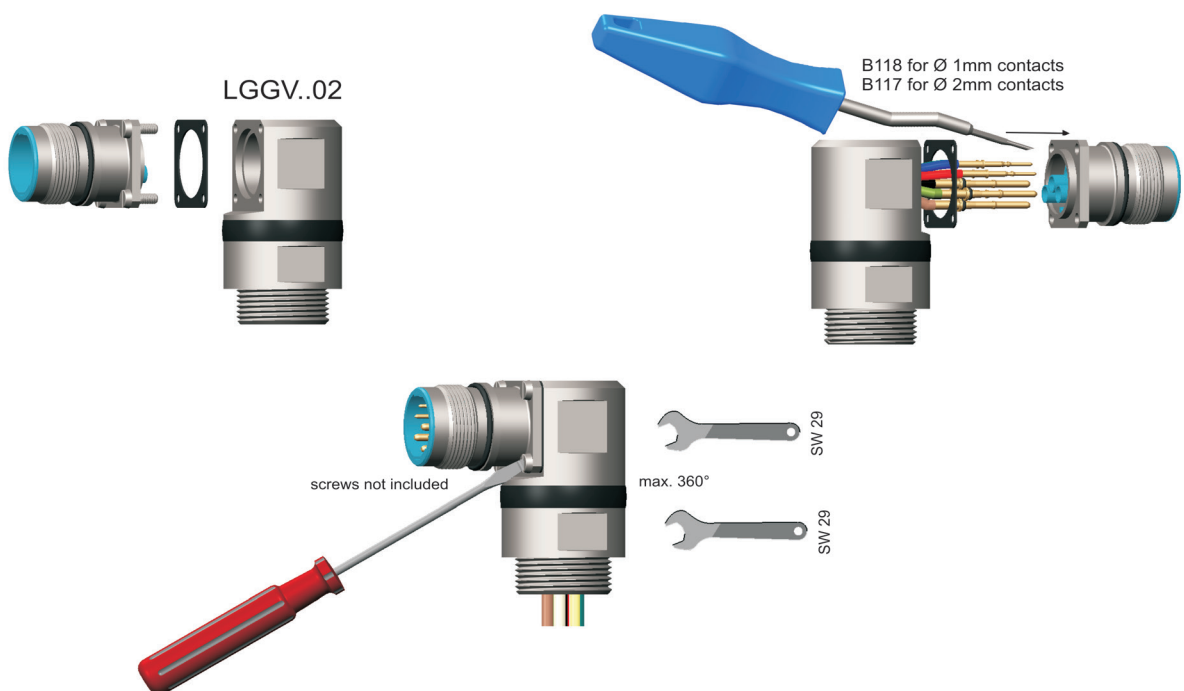
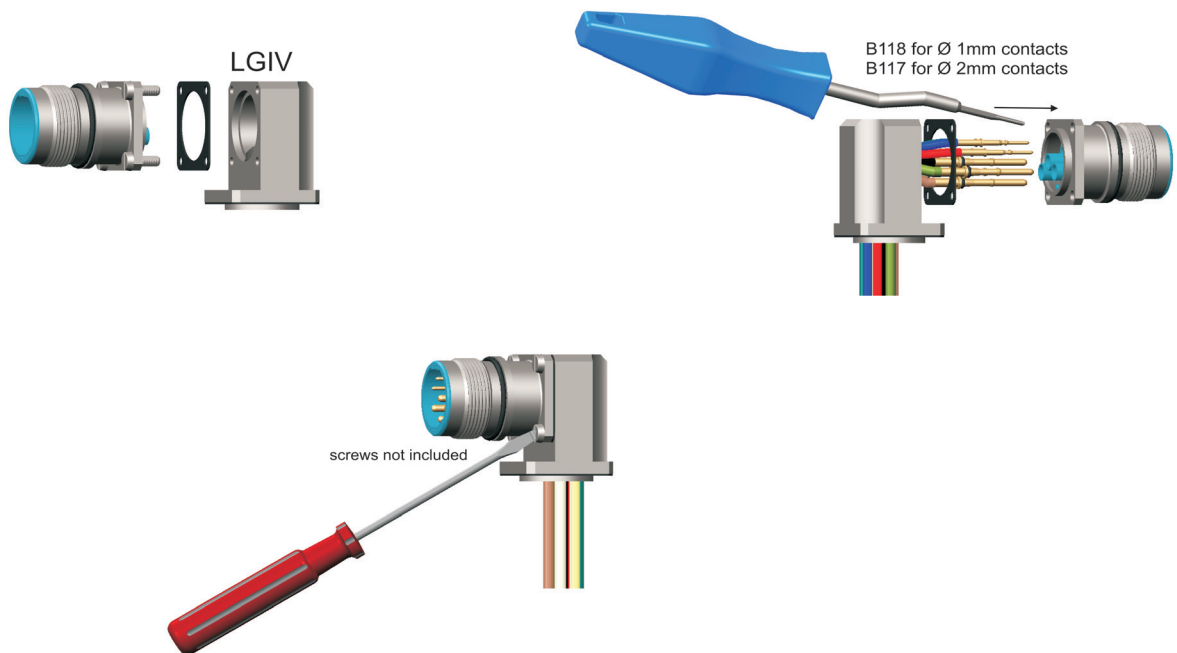

After assembly the connector has to be checked for the functions of the safety precautions (according to EN 60204-1, VDE 0113 Teil 1)

# Assembly instructions

Power extension LSNV...

Stripping Length	
Machined Contacts	
A	7 mm



## Assembly

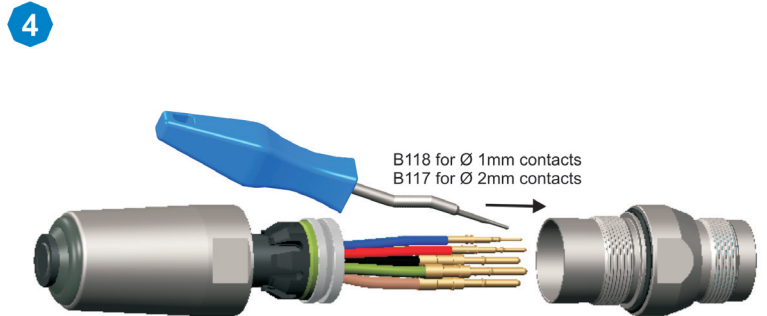
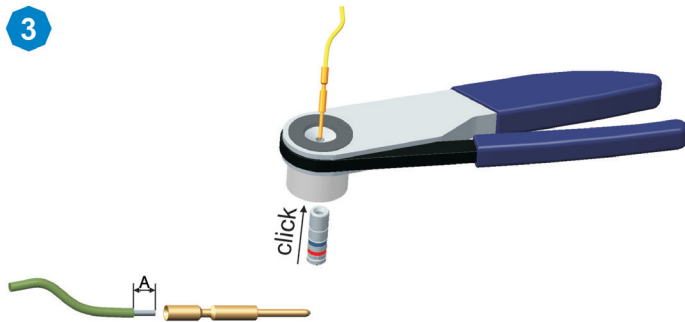
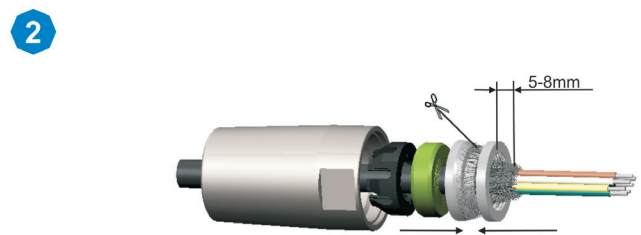
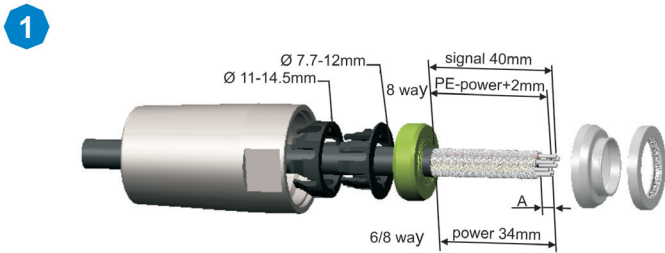

## Dismantling

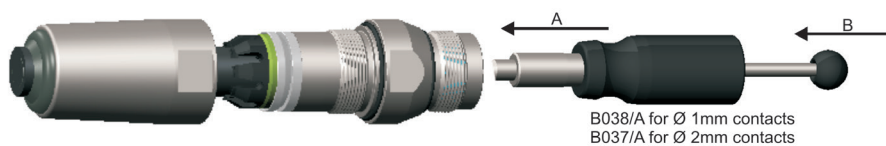

After assembly the connector has to be checked for the functions of the safety precautions (according to EN 60204-1, VDE 0113 Teil 1)

# Assembly instructions

Power Plug LQNV...

Page 1 of 1

	Stripping Length
	Machined Contacts
A	7 mm

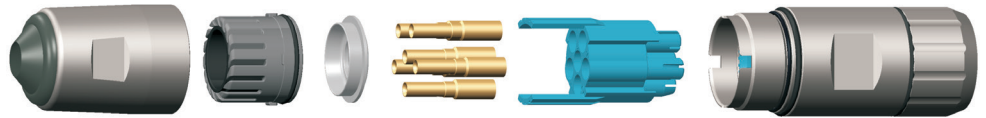

## Assembly

- 1**
- 2**
- 3**
- 4**
- 5**
- 6**

## Dismantling

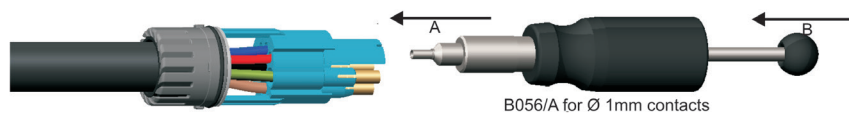

After assembly the connector has to be checked for the functions of the safety precautions (according to EN 60204-1, VDE 0113 Teil 1)

# Assembly instructions

Power bushing LDEV... LDFV... LDEV...01 LDEV...02

Page 1 of 2

	Stripping Length
	Machined Contacts
A	7 mm

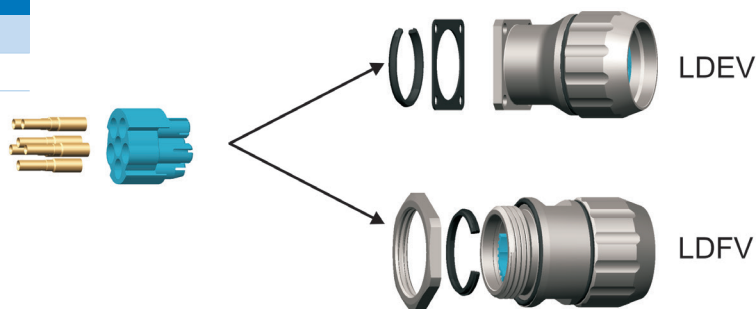

## Assembly

1

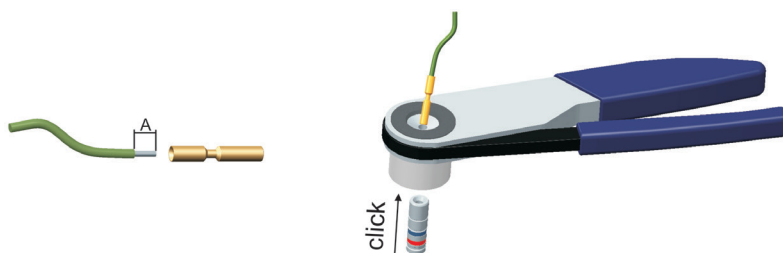

2

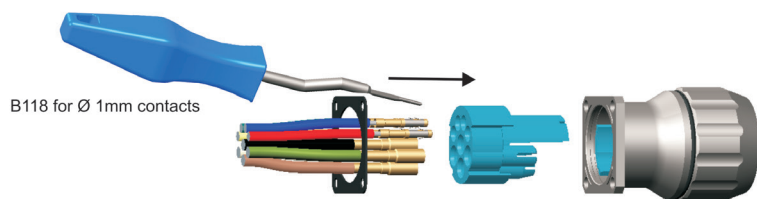

3

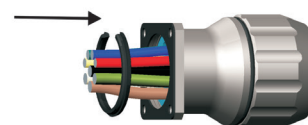

## Dismantling

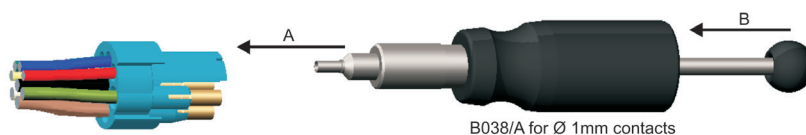

After assembly the connector has to be checked for the functions of the safety precautions (according to EN 60204-1, VDE 0113 Teil 1)

# Assembly instructions

Power bushing LDEV... LDFV... LDEV...01 LDEV...02

Page 2 of 2

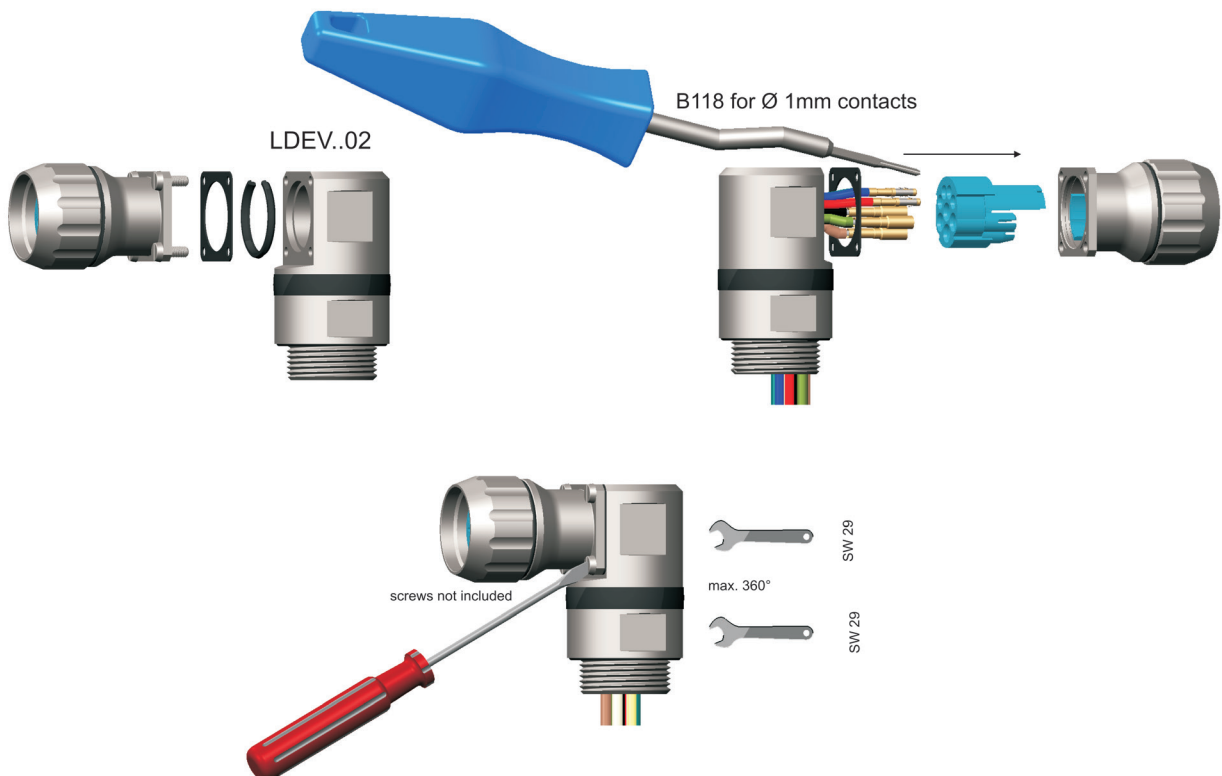
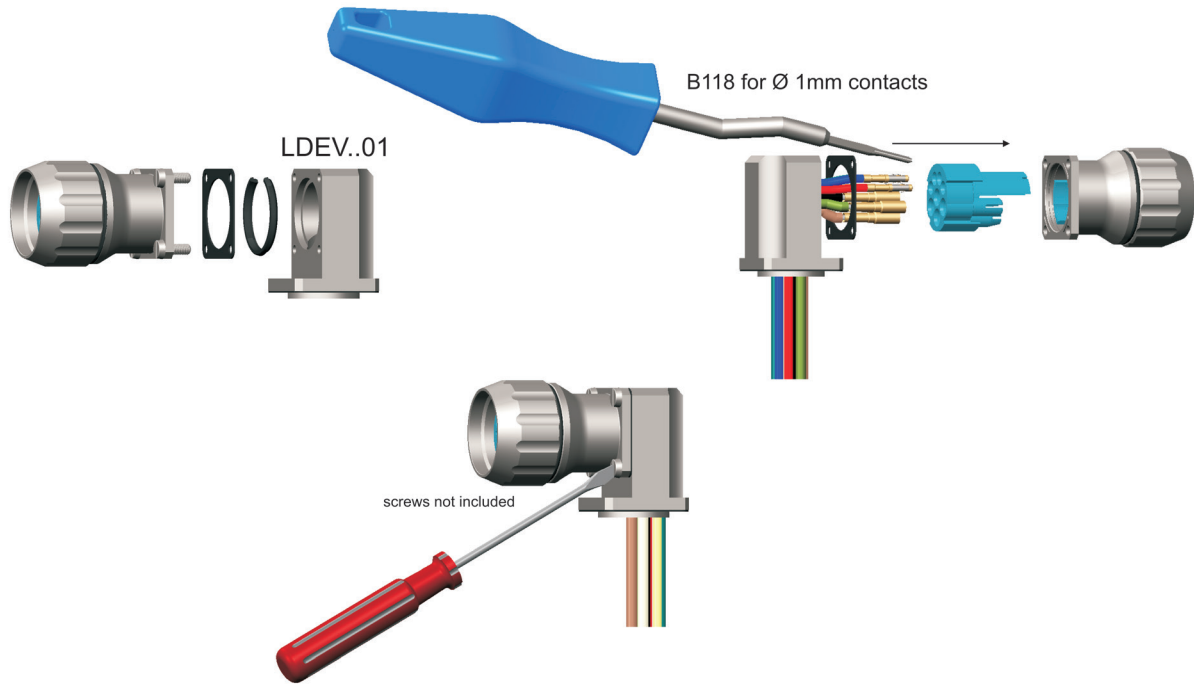

After assembly the connector has to be checked for the functions of the safety precautions (according to EN 60204-1, VDE 0113 Teil 1)

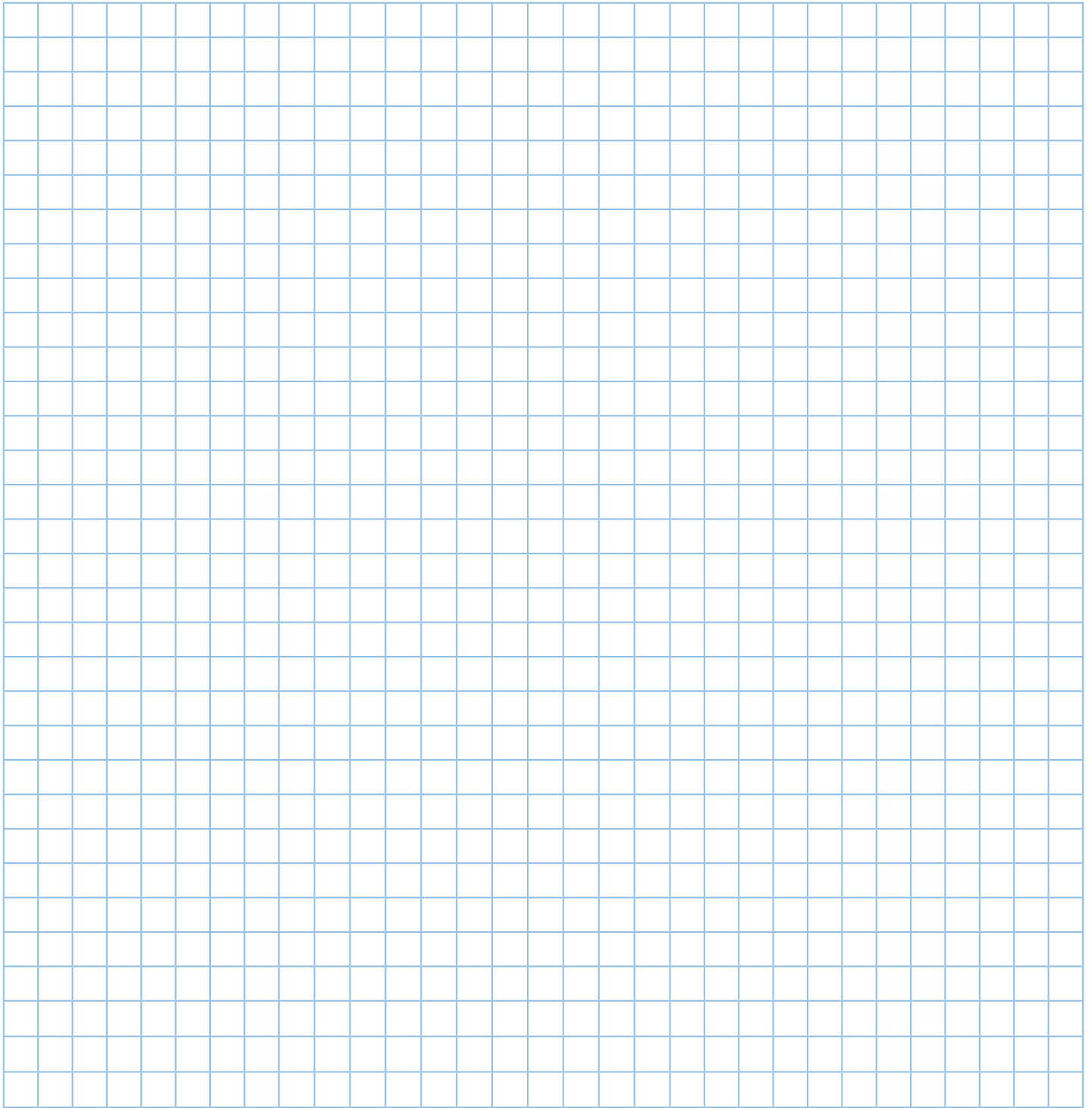

**Notes:**

---

---

---

---

# Type Overview

## M23 Stainless Steel Signal Connectors Series S

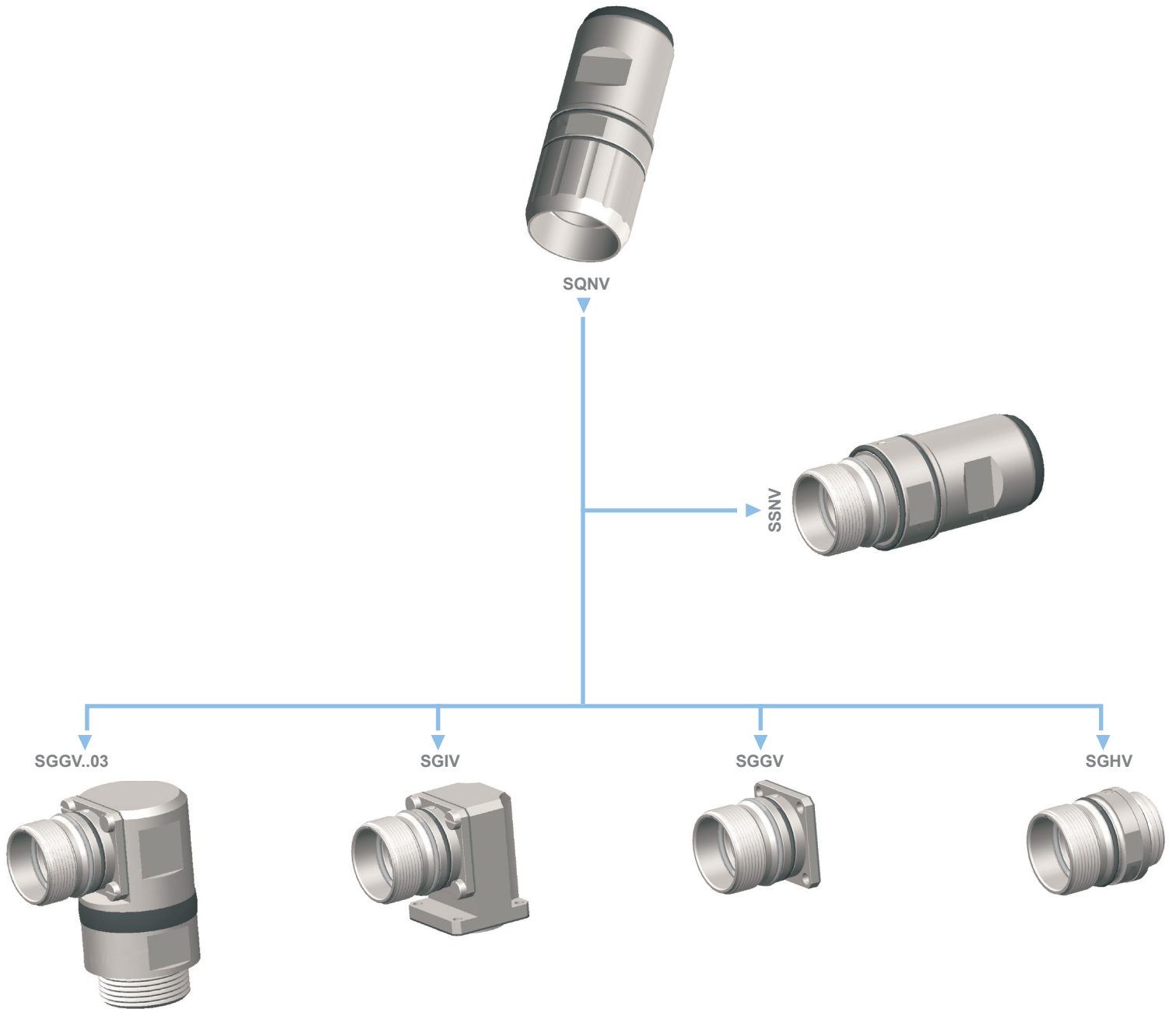

# Technical Characteristics

## M23 Stainless Steel Signal Connectors Series S

### Mechanical

### Standards

Contact diameter 6, 7 and 8poles	Ø 2mm	-
Contact diameter 9, 12, 16, 17poles	Ø 1mm	-

### Material

Shell	V2A (V4A on demand)	-
Contacts	CuZn alloy	-
Insert	PA, PBT	-
Sealing	FKM, EPDM	-

### Material

Shell plating	passivated	-
Machined contacts plating	Gold over nickel	-
Stamped contacts plating	Partly gold plated	-

### Electrical

Current rating	9 A (contact Ø 1mm)	EN 61984
	8 A (contact Ø 1mm)	USR / UL1977
	20 A (contact Ø 2mm)	EN 61984
	20 A (contact Ø 2mm)	USR / UL1977
Voltage rating	50 V AC / 120 V DC	EN 61140
	125 V	USR / UL1977
Withstanding voltage	2500 V	EN 61984
Contact resistance	<5 mΩ (contact Ø 1mm)	EN 61984
	<3 mΩ (contact Ø 2mm)	EN 61984
Insulation resistance	10 <sup>13</sup> Ωcm (contact Ø 1mm)	EN 61984
	10 <sup>16</sup> Ωcm (contact Ø 2mm)	EN 61984
Overvoltage category	III	EN 61984

### Physical and Environmental

Operating temperature range	-40°C ... 125°C	EN 61984
	-40°C ... 110°C	UL1977
Storage conditions	-40°C ... 70°C/ min. humidity 40%	-
Environmental level	IP67 (mated)	DIN EN 60529
Contamination level	3 (mated)	EN 61984
Installation altitude	up to 2000 m	EN 61984
Fire & Smoke	Recognition file No E 178462	UL 1977
RoHS	Compliant	-

Consult factory for details





# How To Order

## M23 Stainless Steel Signal Connectors Series S



### 1 CONNECTOR FAMILY

**S** M23 stainless steel circular connectors, Series S

### 2 CONNECTOR DESIGN

**Q N** plug with variable shield connection and variable cable clamp

**S N** extension with variable shield connection and variable cable clamp

**G G** straight receptacle with flange

**G I** angled receptacle with flange

**G H** straight receptacle, threaded connection M 20x1.5

### 3 PLATING

**V** passivated

### 4 INSERTS

0	6	G	6 x Ø 2mm for extensions and receptacles
0	7	C	7 x Ø 2mm for extensions and receptacle
0	9	E	8 x Ø 1mm + 1 x Ø 2mm for extensions and receptacle
0	9	G	6 x Ø 1mm + 3 x Ø 2mm for extensions and receptacle
0	9	J	9 x Ø 1mm for extensions and receptacle
1	2	T	12 x Ø 1mm for extensions and receptacle
1	2	V	12 x Ø 1mm (Code 20°) for extensions and receptacle
1	6	A	16 x Ø 1mm for extensions and receptacle
1	7	G	17 x Ø 1mm for extensions and receptacle

0	6	H	6 x Ø 2mm for plugs
0	7	D	7 x Ø 2mm for plugs
0	9	F	8 x Ø 1mm + 1 x Ø 2mm for plugs
0	9	H	6 x Ø 1mm + 3 x Ø 2mm for plugs
0	9	K	9 x Ø 1mm for plugs
1	2	S	12 x Ø 1mm for plugs
1	2	U	12 x Ø 1mm (Code 20°) for plugs
1	6	B	16 x Ø 1mm for plugs
1	7	H	17 x Ø 1mm for plugs

### 5 TERMINATION STYLE

N	N	N	N	without contacts, loose machined contacts and stamped HCS contacts on reels to be ordered separately
M	R	R	N	including machined pins, 6/7 x Ø 2mm AWG 18-14
M	R	V	N	including machined pins, 6/7 x Ø 2mm AWG 24-16
M	R	S	R	including machined pins, 8/6 x Ø 1mm AWG 24-18 + 1/3 x Ø 2mm, AWG 18-14
M	R	S	V	including machined pins, 8/6 x Ø 1mm AWG 24-18 + 1/3 x Ø 2mm, AWG 24-16
M	R	W	R	including machined pins, 8/6 x Ø 1mm AWG 30-22 + 1/3 x Ø 2mm, AWG 18-14
M	R	W	V	including machined pins, 8/6 x Ø 1mm AWG 30-22 + 1/3 x Ø 2mm, AWG 24-16
M	R	S	N	including machined pins, 9/12/16/17 x Ø 1mm AWG 24-16
M	R	W	N	including machined pins, 9/12/16/17 x Ø 1mm AWG 30-22

F	R	R	N	including machined sockets, 6/7 x Ø 2mm AWG 20-16
F	R	M	N	including machined sockets, 6/7 x Ø 2mm AWG 18-14
F	R	O	R	including machined sockets, 8/6 x Ø 1mm AWG 24-18 + 1/3 x Ø 2mm, AWG 20-16
F	R	O	M	including machined sockets, 8/6 x Ø 1mm AWG 24-18 + 1/3 x Ø 2mm, AWG 18-14
F	R	P	R	including machined sockets, 8/6 x Ø 1mm AWG 20-16 + 1/3 x Ø 2mm, AWG 20-16
F	R	P	M	including machined sockets, 8/6 x Ø 1mm AWG 20-16 + 1/3 x Ø 2mm, AWG 18-14
F	R	B	R	including machined sockets, 8/6 x Ø 1mm AWG 30-22 + 1/3 x Ø 2mm, AWG 20-16
F	R	B	M	including machined sockets, 8/6 x Ø 1mm AWG 30-22 + 1/3 x Ø 2mm, AWG 18-14
F	R	O	N	including machined sockets, 9/12/16/17 x Ø 1mm AWG 24-18
F	R	P	N	including machined sockets, 9/12/16/17 x Ø 1mm AWG 20-16
F	R	B	N	including machined sockets, 9/12/16/17 x Ø 1mm AWG 30-22

### 6 CABLE CLAMPING

**0 0 0** without cable clamp for receptacles

**1 6 9** variable clamp for cable Ø 5.5mm to 12mm can be used for all shielded and non shielded cables

### 7 VERSION NUMBER

**0 3** depending on type and special design see detailed description of connector design SGGV

# Available Connectors

## Signal plugs Series S with crimp contacts

LAYOUT  
DESCRIPTION  
PART NUMBER CODE

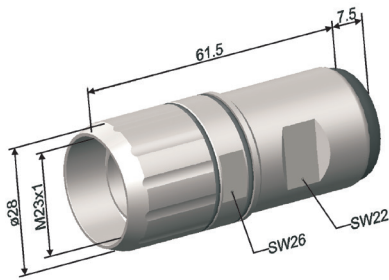

Plug with variable shield connection and variable cable clamp.



SHELL TYPE	CONTACT STYLE	TERMINATION CROSS SECTION
SQNV SQNV*	MACHINED PINS	0.75 - 2.5 0.24 - 1.5 0.24 - 1 / 0.75 - 2.5 0.24 - 1 / 0.24 - 1.5 0.05 - 0.34 / 0.75 - 2.5 0.05 - 0.34 / 0.24 - 1.5 0.24 - 1 0.05 - 0.34
	MACHINED SOCKETS	0.5 - 1.5 0.75 - 2.5 0.24 - 1 / 0.5 - 1.5 0.24 - 1 / 0.75 - 2.5 0.34 - 1.5 / 0.5 - 1.5 0.34 - 1.5 / 0.75 - 2.5 0.05 - 0.34 / 0.5 - 1.5 0.05 - 0.34 / 0.75 - 2.5 0.24 - 1 0.24 - 1.5 0.05 - 0.34
	WITHOUT CONTACTS	

\* UL-Version

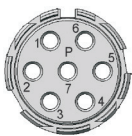
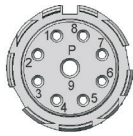
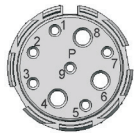
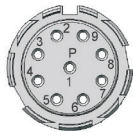
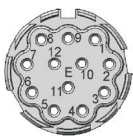
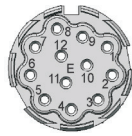
CONTACT ARRANGEMENTS VIEW MATING FACE

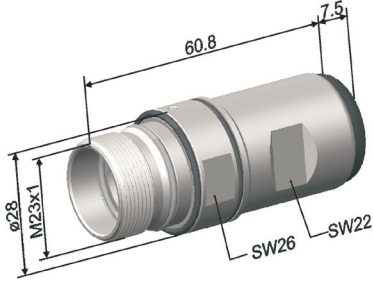

																		CABLE CLAMP
06H (6 x 2)		07D (7 x 2)		09F (8 x 1 / 1 x 2)		09H (6 x 1 / 3 x 2)		09K (9 x 1)		12S (12 x 1)		12U (12 x 1 Code 20°)		16B (16 x 1)		17H (17 x 1)		
06H	MRRN	07D	MRRN															169
06H	MRVN	07D	MRVN															
				09F	MRSR	09H	MRSR											
				09F	MRSV	09H	MRSV											
				09F	MRWR	09H	MRWR											
				09F	MRWV	09H	MRWV											
								09K	MRSN	12S	MRSN	12U	MRSN	16B	MRSN	17H	MRSN	
								09K	MRWN	12S	MRWN	12U	MRWN	16B	MRWN	17H	MRWN	
06H	FRRN	07D	FRRN															
06H	FRMN	07D	FRMN															
				09F	FROR	09H	FROR											
				09F	FROM	09H	FROM											
				09F	FRPR	09H	FRPR											
				09F	FRPM	09H	FRPM											
				09F	FRBR	09H	FRBR											
				09F	FRBM	09H	FRBM											
								09K	FRON	12S	FRON	12U	FRON	16B	FRON	17H	FRON	
								09K	FRPN	12S	FRPN	12U	FRPN	16B	FRPN	17H	FRPN	
								09K	FRBN	12S	FRBN	12U	FRBN	16B	FRBN	17H	FRBN	
								09K	NNNN	12S	NNNN	12U	NNNN	16B	NNNN	17H	NNNN	

## Signal extensions Series S with crimp contacts

LAYOUT DESCRIPTION PART NUMBER CODE	SHELL TYPE	CONTACT STYLE	TERMINATION CROSS SECTION
Extension with variable shield connection and variable cable clamp.  		MACHINED PINS	0.75 - 2.5 0.24 - 1.5 0.24 - 1 / 0.75 - 2.5 0.24 - 1 / 0.24 - 1.5 0.05 - 0.34 / 0.75 - 2.5 0.05 - 0.34 / 0.24 - 1.5 0.24 - 1 0.05 - 0.34
	SSNV SSNV*	MACHINED SOCKETS	0.5 - 1.5 0.75 - 2.5 0.24 - 1 / 0.5 - 1.5 0.24 - 1 / 0.75 - 2.5 0.34 - 1.5 / 0.5 - 1.5 0.34 - 1.5 / 0.75 - 2.5 0.05 - 0.34 / 0.5 - 1.5 0.05 - 0.34 / 0.75 - 2.5 0.24 - 1 0.24 - 1.5 0.05 - 0.34
		WITHOUT CONTACTS	

\* UL-Version

CONTACT ARRANGEMENTS: VIEW MATING FACE

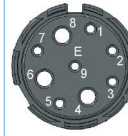
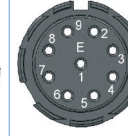
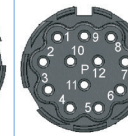
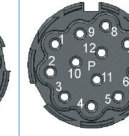
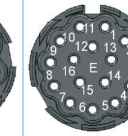
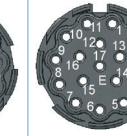
																		CABLE CLAMP
06G (6 x 2)		07C (7 x 2)		09E (8 x 1 / 1 x 2)		09G (6 x 1 / 3 x 2)		09J (9 x 1)		12T (12 x 1)		12V (12 x 1 Code 20°)		16A (16 x 1)		17G (17 x 1)		
06G	MRRN	07C	MRRN															169
06G	MRVN	07C	MRVN															
				09E	MRSR	09G	MRSR											
				09E	MRSV	09G	MRSV											
				09E	MRWR	09G	MRWR											
				09E	MRWV	09G	MRWV											
								09J	MRSN	12T	MRSN	12V	MRSN	16A	MRSN	17G	MRSN	
								09J	MRWN	12T	MRWN	12V	MRWN	16A	MRWN	17G	MRWN	
06G	FRRN	07C	FRRN															
06G	FRMN	07C	FRMN															
				09E	FROR	09G	FROR											
				09E	FROM	09G	FROM											
				09E	FRPR	09G	FRPR											
				09E	FRPM	09G	FRPM											
				09E	FRBR	09G	FRBR											
				09E	FRBM	09G	FRBM											
								09J	FRON	12T	FRON	12V	FRON	16A	FRON	17G	FRON	
								09J	FRPN	12T	FRPN	12V	FRPN	16A	FRPN	17G	FRPN	
								09J	FRBN	12T	FRBN	12V	FRBN	16A	FRBN	17G	FRBN	
								09J	NNNN	12T	NNNN	12V	NNNN	16A	NNNN	17G	NNNN	

# Signal receptacles Series S with crimp contacts

LAYOUT  
DESCRIPTION  
PART NUMBER CODE

Straight receptacle, radial sealing to the device, mounting flange

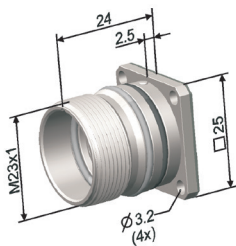

Fixed angled receptacle, radial sealing to the device, mounting flange

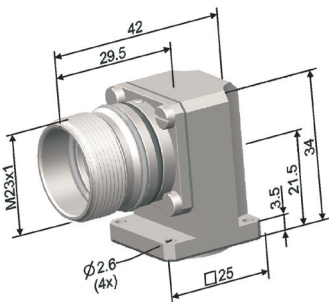

SHELL TYPE	CONTACT STYLE	TERMINATION CROSS SECTION
SGGV SGGV*	MACHINED PINS	0.75 - 2.5 0.24 - 1.5 0.24 - 1 / 0.75 - 2.5 0.24 - 1 / 0.24 - 1.5 0.05 - 0.34 / 0.75 - 2.5 0.05 - 0.34 / 0.24 - 1.5 0.24 - 1 0.05 - 0.34
	MACHINED SOCKETS	0.5 - 1.5 0.75 - 2.5 0.24 - 1 / 0.5 - 1.5 0.24 - 1 / 0.75 - 2.5 0.34 - 1.5 / 0.5 - 1.5 0.34 - 1.5 / 0.75 - 2.5 0.05 - 0.34 / 0.5 - 1.5 0.05 - 0.34 / 0.75 - 2.5 0.24 - 1 0.24 - 1.5 0.05 - 0.34
	WITHOUT CONTACTS	
SGIV SGIV*	MACHINED PINS	0.75 - 2.5 0.24 - 1.5 0.24 - 1 / 0.75 - 2.5 0.24 - 1 / 0.24 - 1.5 0.05 - 0.34 / 0.75 - 2.5 0.05 - 0.34 / 0.24 - 1.5 0.24 - 1 0.05 - 0.34
	MACHINED SOCKETS	0.5 - 1.5 0.75 - 2.5 0.24 - 1 / 0.5 - 1.5 0.24 - 1 / 0.75 - 2.5 0.34 - 1.5 / 0.5 - 1.5 0.34 - 1.5 / 0.75 - 2.5 0.05 - 0.34 / 0.5 - 1.5 0.05 - 0.34 / 0.75 - 2.5 0.24 - 1 0.24 - 1.5 0.05 - 0.34
	WITHOUT CONTACTS	

\* UL-Version

CONTACT ARRANGEMENTS: VIEW MATING FACE

06G (6 x 2)		07C (7 x 2)		09E (8 x 1 / 1 x 2)		09G (6 x 1 / 3 x 2)		09J (9 x 1)		12T (12 x 1)		12V (12 x 1 Code 20°)		16A (16 x 1)		17G (17 x 1)		CABLE CLAMP
06G	MRRN	07C	MRRN															
06G	MRVN	07C	MRVN															
				09E	MRSR	09G	MRSR											
				09E	MRSV	09G	MRSV											
				09E	MRWR	09G	MRWR											
				09E	MRWV	09G	MRWV											
								09J	MRSN	12T	MRSN	12V	MRSN	16A	MRSN	17G	MRSN	
								09J	MRWN	12T	MRWN	12V	MRWN	16A	MRWN	17G	MRWN	
06G	FRRN	07C	FRRN															
06G	FRMN	07C	FRMN															
				09E	FROR	09G	FROR											
				09E	FROM	09G	FROM											
				09E	FRPR	09G	FRPR											
				09E	FRPM	09G	FRPM											
				09E	FRBR	09G	FRBR											
				09E	FRBM	09G	FRBM											
								09J	FRON	12T	FRON	12V	FRON	16A	FRON	17G	FRON	
								09J	FRPN	12T	FRPN	12V	FRPN	16A	FRPN	17G	FRPN	
								09J	FRBN	12T	FRBN	12V	FRBN	16A	FRBN	17G	FRBN	
06G	NNNN	07C	NNNN	09E	NNNN	09G	NNNN	09J	NNNN	12T	NNNN	09G	NNNN	09J	NNNN	17G	NNNN	
06G	MRRN	07C	MRRN															
06G	MRVN	07C	MRVN															
				09E	MRSR	09G	MRSR											
				09E	MRSV	09G	MRSV											
				09E	MRWR	09G	MRWR											
				09E	MRWV	09G	MRWV											
								09J	MRSN	12T	MRSN	12V	MRSN	16A	MRSN	17G	MRSN	
								09J	MRWN	12T	MRWN	12V	MRWN	16A	MRWN	17G	MRWN	
06G	FRRN	07C	FRRN															
06G	FRMN	07C	FRMN															
				09E	FROR	09G	FROR											
				09E	FROM	09G	FROM											
				09E	FRPR	09G	FRPR											
				09E	FRPM	09G	FRPM											
				09E	FRBR	09G	FRBR											
				09E	FRBM	09G	FRBM											
								09J	FRON	12T	FRON	12V	FRON	16A	FRON	17G	FRON	
								09J	FRPN	12T	FRPN	12V	FRPN	16A	FRPN	17G	FRPN	
								09J	FRBN	12T	FRBN	12V	FRBN	16A	FRBN	17G	FRBN	
								09J	NNNN	12T	NNNN	12V	NNNN	16A	NNNN	17G	NNNN	

Drilling drawings

SGGV, SGIV

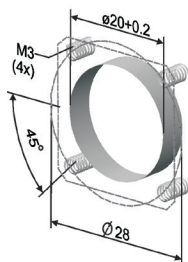

# Signal receptacles Series S with crimp contacts

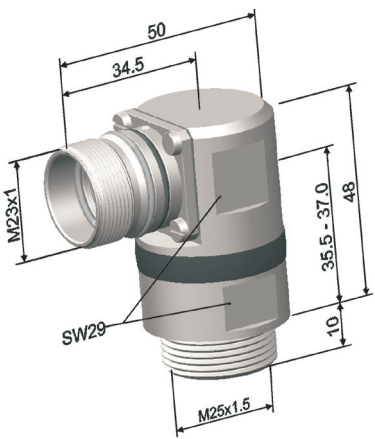
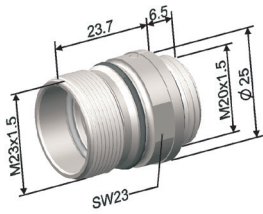
LAYOUT DESCRIPTION PART NUMBER CODE	SHELL TYPE	CONTACT STYLE	TERMINATION CROSS SECTION
Straight receptacle, radial sealing to the device, mounting flange  	<b>SGGV</b> <b>SGGV*</b>	MACHINED PINS	0.75 - 2.5 0.24 - 1.5 0.24 - 1 / 0.75 - 2.5 0.24 - 1 / 0.24 - 1.5 0.05 - 0.34 / 0.75 - 2.5 0.05 - 0.34 / 0.24 - 1.5 0.24 - 1 0.05 - 0.34
Fixed angled receptacle, radial sealing to the device, mounting flange  		MACHINED SOCKETS	0.5 - 1.5 0.75 - 2.5 0.24 - 1 / 0.5 - 1.5 0.24 - 1 / 0.75 - 2.5 0.34 - 1.5 / 0.5 - 1.5 0.34 - 1.5 / 0.75 - 2.5 0.05 - 0.34 / 0.5 - 1.5 0.05 - 0.34 / 0.75 - 2.5 0.24 - 1 0.24 - 1.5 0.05 - 0.34
		WITHOUT CONTACTS	0.75 - 2.5 0.24 - 1.5 0.24 - 1 / 0.75 - 2.5 0.24 - 1 / 0.24 - 1.5 0.05 - 0.34 / 0.75 - 2.5 0.05 - 0.34 / 0.24 - 1.5 0.24 - 1 0.05 - 0.34
	<b>SGHV</b> <b>SGHV*</b>	MACHINED PINS	0.5 - 1.5 0.75 - 2.5 0.24 - 1 / 0.5 - 1.5 0.24 - 1 / 0.75 - 2.5 0.34 - 1.5 / 0.5 - 1.5 0.34 - 1.5 / 0.75 - 2.5 0.05 - 0.34 / 0.5 - 1.5 0.05 - 0.34 / 0.75 - 2.5 0.24 - 1 0.24 - 1.5 0.05 - 0.34
MACHINED SOCKETS		0.5 - 1.5 0.75 - 2.5 0.24 - 1 / 0.5 - 1.5 0.24 - 1 / 0.75 - 2.5 0.34 - 1.5 / 0.5 - 1.5 0.34 - 1.5 / 0.75 - 2.5 0.05 - 0.34 / 0.5 - 1.5 0.05 - 0.34 / 0.75 - 2.5 0.24 - 1 0.24 - 1.5 0.05 - 0.34	
WITHOUT CONTACTS		0.75 - 2.5 0.24 - 1.5 0.24 - 1 / 0.75 - 2.5 0.24 - 1 / 0.24 - 1.5 0.05 - 0.34 / 0.75 - 2.5 0.05 - 0.34 / 0.24 - 1.5 0.24 - 1 0.05 - 0.34	

\* UL-Version



CONTACT ARRANGEMENTS: VIEW MATING FACE

												CABLE CLAMP																	
06G (6 x 2)		07C (7 x 2)		09E (8 x 1 / 1 x 2)		09G (6 x 1 / 3 x 2)		09J (9 x 1)		12T (12 x 1)			12V (12 x 1 Code 20°)		16A (16 x 1)		17G (17 x 1)		000 03										
06G	MRRN	07C	MRRN																	000 03									
06G	MRVN	07C	MRVN																000										
				09E	MRSR	09G	MRSR														000								
				09E	MRSV	09G	MRSV															000							
				09E	MRWR	09G	MRWR																000						
				09E	MRWV	09G	MRWV																	000					
								09J	MRSN	12T	MRSN	12V	MRSN	16A	MRSN	17G	MRSN								000				
								09J	MRWN	12T	MRWN	12V	MRWN	16A	MRWN	17G	MRWN									000			
06G	FRRN	07C	FRRN																								000 03		
06G	FRMN	07C	FRMN																									000	
				09E	FROR	09G	FROR																						000
				09E	FROM	09G	FROM																						
				09E	FRPR	09G	FRPR													000									
				09E	FRPM	09G	FRPM												000										
				09E	FRBR	09G	FRBR														000								
				09E	FRBM	09G	FRBM															000							
								09J	FRON	12T	FRON	12V	FRON	16A	FRON	17G	FRON						000						
								09J	FRPN	12T	FRPN	12V	FRPN	16A	FRPN	17G	FRPN							000					
								09J	FRBN	12T	FRBN	12V	FRBN	16A	FRBN	17G	FRBN								000				
06G	NNNN	07C	NNNN	09E	NNNN	09G	NNNN	09J	NNNN	12T	NNNN	09G	NNNN	09J	NNNN	17G	NNNN									000			
06G	MRRN	07C	MRRN																								000		
06G	MRVN	07C	MRVN																									000	
				09E	MRSR	09G	MRSR																						000
				09E	MRSV	09G	MRSV																						
				09E	MRWR	09G	MRWR													000									
				09E	MRWV	09G	MRWV												000										
								09J	MRSN	12T	MRSN	12V	MRSN	16A	MRSN	17G	MRSN				000								
								09J	MRWN	12T	MRWN	12V	MRWN	16A	MRWN	17G	MRWN					000							
06G	FRRN	07C	FRRN																				000						
06G	FRMN	07C	FRMN																					000					
				09E	FROR	09G	FROR																		000				
				09E	FROM	09G	FROM																			000			
				09E	FRPR	09G	FRPR																				000		
				09E	FRPM	09G	FRPM																					000	
				09E	FRBR	09G	FRBR																						000
				09E	FRBM	09G	FRBM																						
								09J	FRON	12T	FRON	12V	FRON	16A	FRON	17G	FRON			000									
								09J	FRPN	12T	FRPN	12V	FRPN	16A	FRPN	17G	FRPN		000										
								09J	FRBN	12T	FRBN	12V	FRBN	16A	FRBN	17G	FRBN				000								
								09J	NNNN	12T	NNNN	12V	NNNN	16A	NNNN	17G	NNNN					000							

Drilling drawings



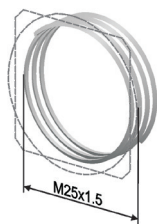

SGGV..03

SGHV



# Contacts

## Machined Pins Series S



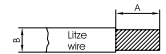

Type	R	V	S	T	W
Contact diameter [mm]	2	2	1	1	1
Part number and layout					
	021.310.1020 	021.356.1020 	021.311.1020 	021.373.1020 	021.402.1020 
Termination cross section* [mm <sup>2</sup> ] AWG	0.75 - 2.5 (18 - 14)	0.34 - 1.5 (24 - 16)	0.24 - 1.0 (24 - 18)	0.24 - 1.0 (24 - 18)	0.05 - 0.34 (30 - 22)
Max. nominal current [A] (20°C) at max. cross section	20	20	9	9	9
Strip length (A) [mm]	~ 5.5	~ 5.5	(B = <math>\leq \varnothing 2.1</math>) ~ 4 (B = <math>> \varnothing 2.1</math>) ~ 6	(B = <math>\leq \varnothing 2.1</math>) ~ 4 (B = <math>> \varnothing 2.1</math>) ~ 6	~ 5
Contact resistance [mΩ]	<3	<3	<5	<5	<5
Max. conductor diameter [mm]	2.2	1.8	1.2	1.2	0.8
Max. insulation diameter [mm] for insulation crimp	-	-	2.1	2.1	-



\*Mentioned crimp ranges are recommendations and only valid with flexible wires H05(07)V-K [mm<sup>2</sup>] acc. to DIN VDE 0281/0282 pp and with non compressed standard cables and wires acc. to DIN VDE 0295. It is possible that due to another structure of wires further cross sections and currents can be processed.

Tooling					
Hand crimping tool	B151	B151	B150	B150	B150
Positioner	B201	B201	B055/A	B055/A	B055/A
Insertion tool	-	-	-	-	-
Extraction tool	-	-	-	-	-

## Machined Sockets Series S



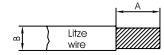

Type	R	M	O	P	B
Contact diameter [mm]	2	2	1	1	1
Part number and layout					
	020.315.1020 	020.263.1020 	020.256.1020 	020.328.1020 	020.353.1020 
Termination cross section* [mm <sup>2</sup> ] AWG	0.5 - 1.5 (20 - 16)	0.75 - 2.5 (18 - 14)	0.24 - 1.0 (24 - 18)	0.5 - 1.5 (20 - 16)	0.05 - 0.34 (30 - 22)
Max. nominal current [A] (20°C) at max. cross section	20	20	9	9	9
Strip length (A) [mm]	~ 5.5	~ 5.5	(B = <math>\leq \varnothing 2.1</math>) ~ 4 (B = <math>> \varnothing 2.1</math>) ~ 6	~ 5	~ 5
Contact resistance [mΩ]	<3	<3	<5	<5	<5
Max. conductor diameter [mm]	1.7	2.2	1.2	-	-
Max. insulation diameter [mm] for insulation crimp	-	-	2.1	-	-



\*Mentioned crimp ranges are recommendations and only valid with flexible wires H05(07)V-K [mm<sup>2</sup>] acc. to DIN VDE 0281/0282 pp and with non compressed standard cables and wires acc. to DIN VDE 0295. It is possible that due to another structure of wires further cross sections and currents can be processed.

Tooling					
Hand crimping tool	B151	B151	B150	B151	B150
Positioner	B201	B201	B055/A	B257	B055/A
Insertion tool	-	-	-	-	-
Extraction tool	-	-	-	-	-

## Stamped HCS™ Pins Series S

Type	A	B	C	D
Contact diameter [mm]	1	1	1	1
Part number and layout				
Termination cross section* [mm²] AWG	0.03 - 0.08 (32 - 28)	0.08 - 0.2 (28 - 24)	0.2 - 0.5 (24 - 20)	0.75 - 1.0 (18)
Max. nominal current [A] (20°C) at max. cross section	4	6	8	8
Strip length (A) [mm]	~ 3	~ 3	~ 3	~ 3
Contact resistance [mΩ]	<5	<5	<5	<5
9000 pcs. big reel part number	021.001005.1025	021.001006.1025	021.001007.1025	021.001008.1025
300 pcs. small reel part number	021.001005.1025.A2	021.001006.1025.A2	021.001007.1025.A2	021.001008.1025.A2





\*Mentioned crimp ranges are recommendations and only valid with flexible wires H05(07)V-K [mm²] acc. to DIN VDE 0281/0282 pp and with non compressed standard cables and wires acc. to DIN VDE 0295. It is possible that due to another structure of wires further cross sections and currents can be processed.

Tooling				
Hand crimping tool for small reels	B287/32-28	B287/28-24	B287/24-20	B287/0.75-1
Applicator for crimping machine	B288/32-28	B288/28-24	B288/24-20	B288/0.75-1

Schäfer \*\*

\*\*acc. to AMP standard

## Stamped HCS™ Sockets Series S

Type	A	B	C	D
Contact diameter [mm]	1	1	1	1
Part number and layout				
	020.000376.2000 	020.000377.2000 	020.000378.2000 	020.000379.2000 
Termination cross section* [mm²] AWG	0.03 - 0.08 (32 - 28)	0.08 - 0.2 (28 - 24)	0.2 - 0.5 (24 - 20)	0.75 - 1.0 (18)
Max. nominal current [A] (20°C) at max. cross section	4	6	8	8
Strip length (A) [mm]	~ 3	~ 3	~ 3	~ 3
Contact resistance [mΩ]	<5	<5	<5	<5
9000 pcs. big reel part number	020.000376.2000	020.000377.2000	020.000378.2000	020.000379.2000
300 pcs. small reel part number	020.000376.2000.A2	020.000377.2000.A2	020.000378.2000.A2	020.000379.2000.A2

\*Mentioned crimp ranges are recommendations and only valid with flexible wires H05(07)V-K [mm²] acc. to DIN VDE 0281/0282 pp and with non compressed standard cables and wires acc. to DIN VDE 0295. It is possible that due to another structure of wires further cross sections and currents can be processed.

Tooling				
Hand crimping tool for small reels	B287/32-28	B287/28-24	B287/24-20	B287/0.75-1
Applicator for crimping machine	B288/32-28	B288/28-24	B288/24-20	B288/0.75-1

Schäfer \*\*

\*\*acc. to AMP standard

# Assembly instructions

Signal extension SSNV...

	Stripping Length	
	Machined Contacts	Stamped Contacts
A	see catalogue page 32 - 33	~3 mm

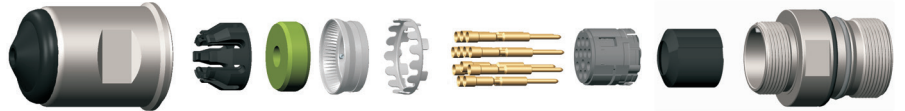

## Assembly

- 1**
- 2**
- 3**
- 4**
- 5**
- 6**

## Dismantling

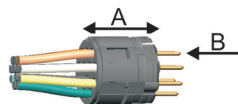

After assembly the connector has to be checked for the functions of the safety precautions (according to EN 60204-1, VDE 0113 Teil 1)

# Assembly instructions

Signal plug SQNV.....

Page 1 of 1

	Stripping Length	
	Machined Contacts	Stamped Contacts
A	see catalogue page 32 - 33	~3 mm

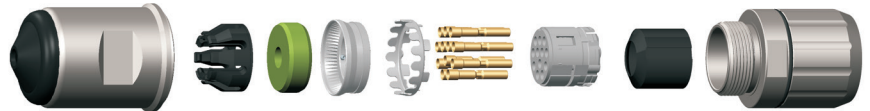

## Assembly

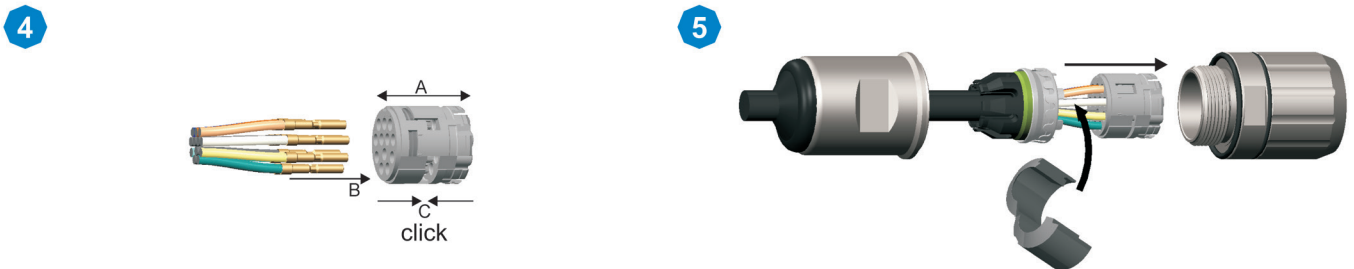
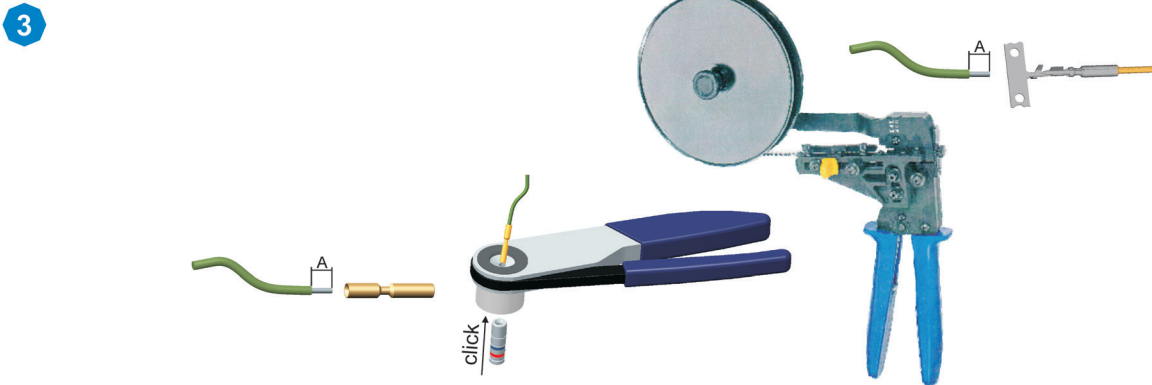
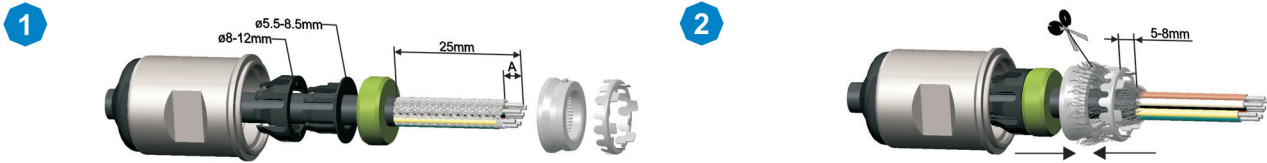

## Dismantling

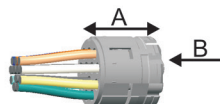

After assembly the connector has to be checked for the functions of the safety precautions (according to EN 60204-1, VDE 0113 Teil 1)

# Assembly instructions

Signal receptacles SGGV... SGHV... SGIV... SGGV...03

Page 1 of 2

A	Stripping Length	
	Machined Contacts	Stamped Contacts
	see catalogue page 32 - 33	~3 mm

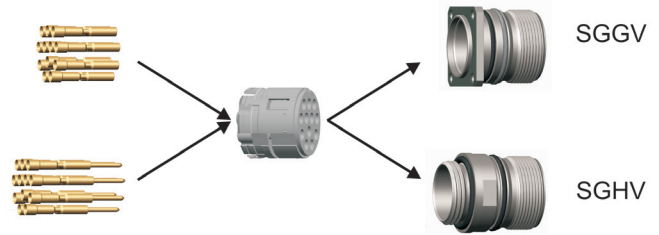

## Assembly

1

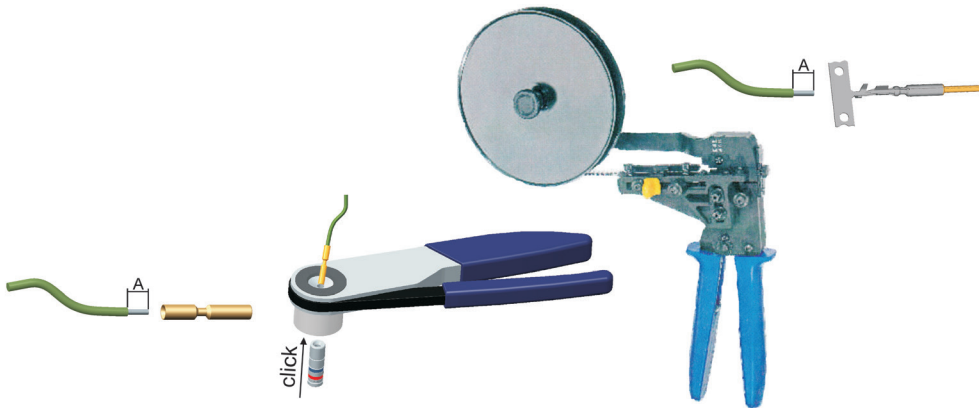

2

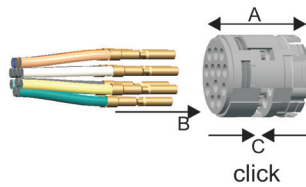

3

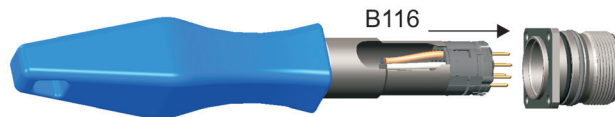

## Dismantling



After assembly the connector has to be checked for the functions of the safety precautions (according to EN 60204-1, VDE 0113 Teil 1)



# Assembly instructions

Signal receptacles SGGV... SGHV... SGIV... SGGV...03



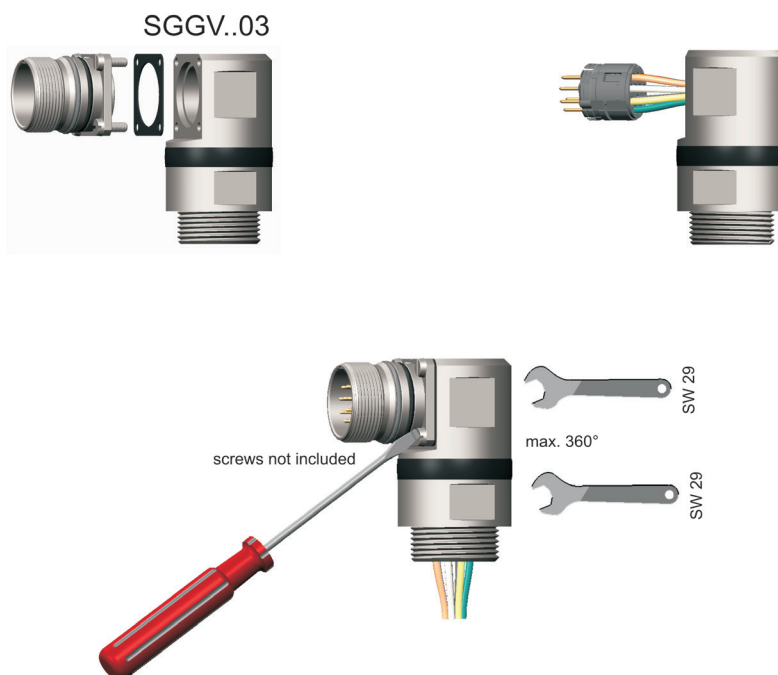
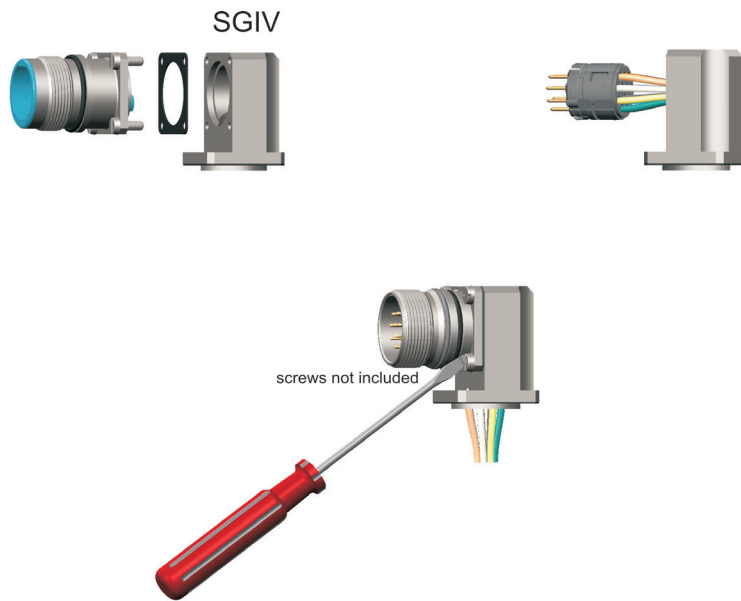

Page 2 of 2





After assembly the connector has to be checked for the functions of the safety precautions (according to EN 60204-1, VDE 0113 Teil 1)

# Tools

## Machined Contacts

Hand crimping tool	Positioner	Part number
 <p>B150</p>		B055/A B201 B245 B257 B297 B305 B306
 <p>B151</p>		B190 B230

## Insertion and Extraction Tools

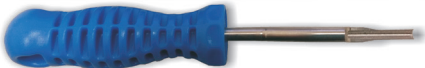
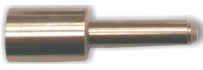
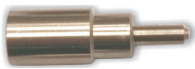
Insertion tool	Extraction tool	Part number
 <p>B117</p>		B132
 <p>B118</p>		B037/10a
		B038/10

## Stamped Contacts

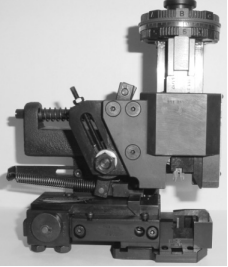
Hand crimping tools with feeder line for HCS™ Ø 1mm	Termination Cross Section	Part number
 <p data-bbox="400 931 480 958">B287/..</p>	<p data-bbox="852 591 1182 703">0.032 - 0.08mm<sup>2</sup> (AWG 32-28) 0.08 - 0.20mm<sup>2</sup> (AWG 28-24) 0.20 - 0.52mm<sup>2</sup> (AWG 24-20) 0.75 - 1.00mm<sup>2</sup></p>	<p data-bbox="1209 591 1378 703">B287/32-28 B287/28-24 B287/24-20 B287/0.75-1.00</p>
Applicators for crimping machines with feeder line	Termination cross section	Part number
 <p data-bbox="304 1301 576 1328">AMP / Schäfer ESP1000</p>	<p data-bbox="852 1122 1182 1234">0.032 - 0.08mm<sup>2</sup> (AWG 32-28) 0.08 - 0.20mm<sup>2</sup> (AWG 28-24) 0.20 - 0.52mm<sup>2</sup> (AWG 24-20) 0.75 - 1.00mm<sup>2</sup></p>	<p data-bbox="1209 1122 1394 1234">B288/32 - 28 B288/28 - 24 B288/24 - 20 B288/0.75 - 1.00</p>

# Cable Clamps

## Cable clamp No. 169 for SSNV/SQNV

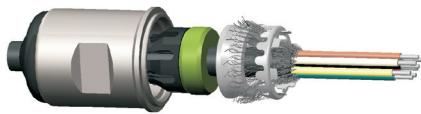

### Clamp range

with reducing sleeve from 5.5 - 8.5mm  
without reducing sleeve from 8-12mm  
can be used for shielded and non shielded cables

## Cable clamp No. 170 for LSNV

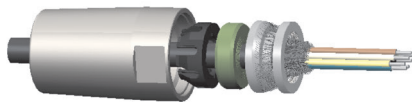

### Clamp range

with reducing sleeve from 7.7 - 12mm  
without reducing sleeve from 11-14.5mm  
can be used for shielded and non shielded cables

## Cable clamps No. 305/306/307 for LQNV

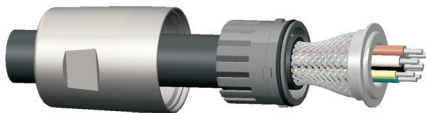





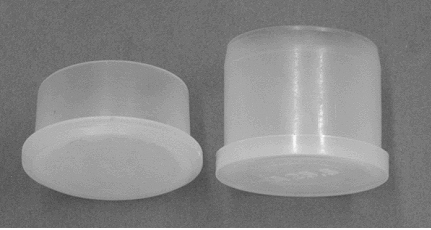

### Clamp range

.305 cable diameter 5 - 9 mm  
.306 cable diameter 9 -15 mm  
.307 cable diameter 16 mm  
can be used for shielded and non shielded cables

# Assessories

## Caps

Thread Protection Caps	Part number	
	<p>031.287.1000 (short) 031.405.1000 (long)</p>	
Dust Shield Caps	Part number	Description
	<p>C/BEL/1</p>	<p>dust shield cap for extension and receptacle</p>
	<p>C/BEL/2</p>	<p>identical to C/BEL/1 with chain 75mm</p>
	<p>C/BEL/7</p>	<p>identical to C/BEL/1 with chain 120mm</p>
	<p>C/BEL/5</p>	<p>dust shield cap for power plug and panel feed through with chain 120mm</p>
	<p>C/BEL/6</p>	<p>dust shield cap for signal plug with chain 120mm</p>

CuZn alloy dust shield caps, nickel plated. Stainless steel quality on demand

## Disclaimer 2018

All of the information included in this catalogue is believed to be accurate at the time of printing. It is recommended, however, that users should independently evaluate the suitability of each product for their intended application and be sure that each product is properly installed, used and maintained to achieve desired results.

Smiths Interconnect makes no warranties as to the accuracy or completeness of the information, and disclaims any liability regarding its use.

Smiths Interconnect reserves the right to modify design and specifications, in order to improve quality, keep pace with technological development or meet specific production requirements.

No reproduction or use without express permission of editorial and pictorial content, in any manner.

# Product Portfolio

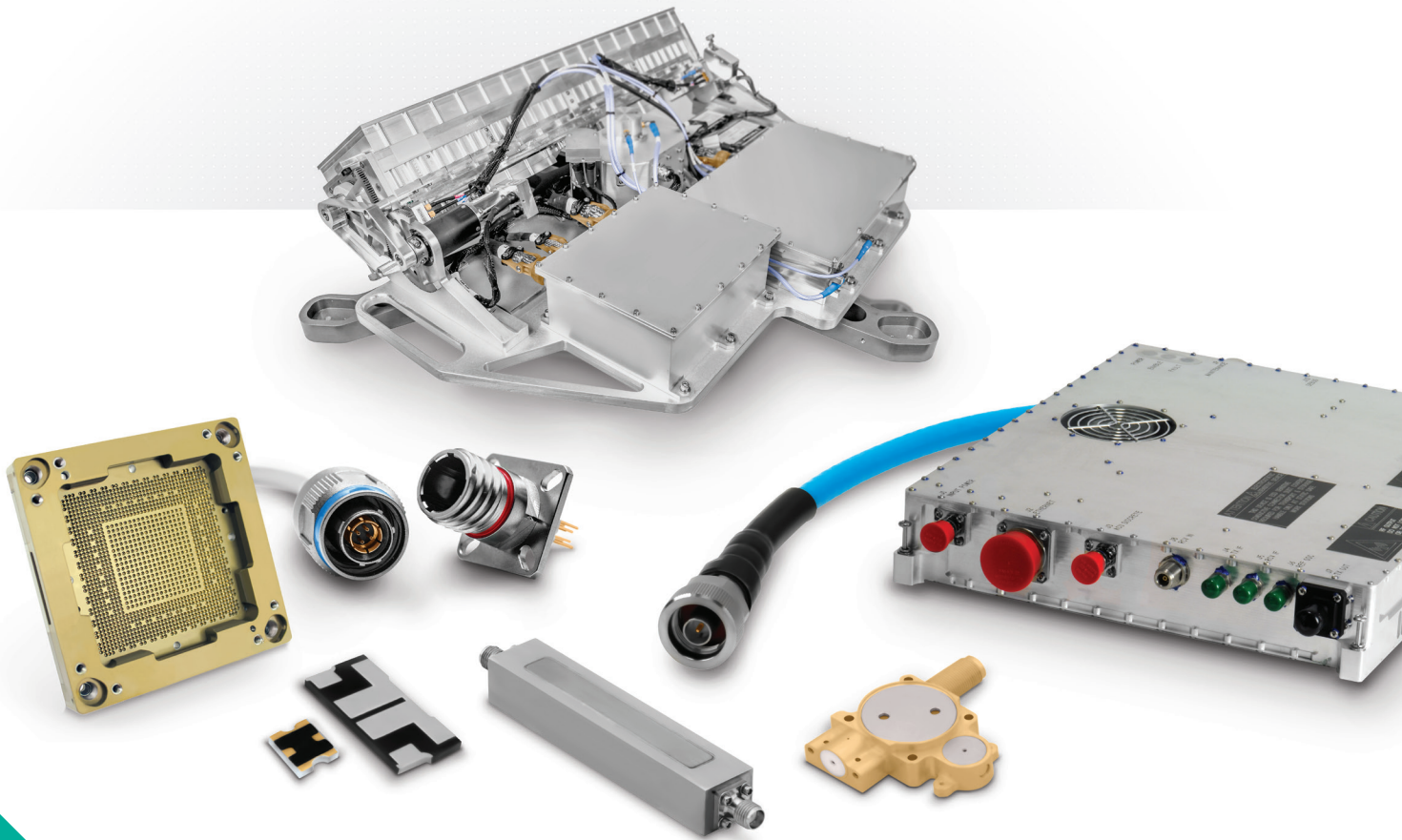

- Antenna Systems
  - Cable Assemblies
  - Connector Solutions
    - Ferrite Components & Assemblies
      - RF Filter Components & Assemblies
      - Integrated Microwave Assemblies
      - Millimeter-Wave Solutions
      - RF Components
        - Test Sockets and WLCSP Probe Heads
        - Time & Frequency Systems

# Global Support

## UK Headquarters

- London, UK  
+44 20 7004 1600  
info.uk@smithsinterconnect.com

## US Headquarters

- Stuart, FL  
+1 772 286 9300  
info.us@smithsinterconnect.com

## Americas

- Costa Mesa, CA  
+1 714 371 1100  
info.us@smithsinterconnect.com
- Milpitas, CA  
+1 408 957 9607 x 1125  
info.us@smithsinterconnect.com
- Stuart, FL  
+1 772 286 9300  
info.us@smithsinterconnect.com
- Hudson, MA  
+1 978 568 0451  
info.us@smithsinterconnect.com
- Northampton, MA  
+1 413 582 9620  
info.northampton@smithsinterconnectinc.com
- Tampa, FL  
+ 1 813 901 7200  
info.tampa@smithsinterconnectinc.com
- Kansas City, KS  
+1 913 342 5544  
info.us@smithsinterconnect.com
- Salisbury, MD  
+1 800 780 2169  
info.us@smithsinterconnect.com
- Thousand Oaks, CA  
+1 805 267 0100  
info.thousandoaks@smithsinterconnectinc.com

## Europe

- Deggendorf, Germany  
+49 991 250 120  
info.de@smithsinterconnect.com
- Genova, Italy  
+39 0 10 60361  
info.it@smithsinterconnect.com
- Dundee, UK  
+44 1382 427 200  
info.dundee@smithsinterconnect.com
- Rouen, France  
+33 2 32 96 91 76  
info.fr@smithsinterconnect.com
- Elstree, UK  
+44 20 8236 2400  
info.uk@smithsinterconnect.com

## Asia

- Shanghai, China  
+86 21 2283 8008  
info.asia@smithsinterconnect.com
- Suzhou, China  
+86 512 6273 1188  
info.asia@smithsinterconnect.com
- Singapore  
+65 6846 1655  
info.asia@smithsinterconnect.com

more > [smithsinterconnect.com](https://www.smithsinterconnect.com) | [in](#) [twitter](#) [G+](#) [YouTube](#)



## X-ON Electronics

Largest Supplier of Electrical and Electronic Components

*Click to view similar products for [Contact Probes](#) category:*

*Click to view products by [Smiths Interconnect](#) manufacturer:*

Other Similar products are found below :

[CT5253](#) [CT5082](#) [100039-033-958](#) [100077-003-0-0](#) [300122-031-1102](#) [R-2-RP-375](#) [S-4-C-5-G S/C](#) [300122-056-0203](#) [SS-75-B-2.4-G](#) [ICT-100-J-17-G](#) [SS-75-C-4.9-D D/C .620 OAL](#) [100165-033-952](#) [100024-002-942](#) [SS-75-E-4.9-D D/C .620 OAL](#) [SX-0-U-2.2-G D/C](#) [101740-028-948](#) [ICT-100-V8-8-G S/C](#) [ICT-100-A-8-G S/C](#) [ICT-075-B-10-G-S S/C](#) [S-2-D-8.3-G D/C](#) [S-2-D-10-G D/C](#) [GSS-19-7-G S/C OAL](#) [ICT-100-T-8-G S/C](#) [GSS-4-7-G](#) [S-0-B9-2.5-G S/C](#) [SS-40-J-2.4-G D/C](#) [S-0-A-2.2-D 660 S/C](#) [SS-50-J-3.3-D S/C](#) [S-0-V-3.7-G S/C](#) [SX-2-B-7-G D/C](#) [SX-1-U-6.6-G D/C](#) [SX-1-C-6.6-G D/C](#) [SS-75-D-4.9-D D/C .620 OAL](#) [SS-50-E-2.9-G S/C](#) [SS-40-J-1.8-G-N/L D/C](#) [SS-3-7-G S/C W/HOLE .373 OAL](#) [SS-18-7-G S/C W/HOLE .405 OAL](#) [SS-10-7-G S/C W/HOLE .373 OAL](#) [SS-1-7-G S/C W/HOLE .385 OAL](#) [SHE-5-H-18.7-G](#) [SHE-5-B-18.7-G](#) [SHE-5-A-18.7-G](#) [SHE-3-A-7-G](#) [SH-4-A-10-G S/C](#) [101057-001-952](#) [S-50C-HS-4.3-DG-S](#) [S-5-F-8-G S/C SS SPGS](#) [S-5-F-16.4-G S/C](#) [S-4-E-5-D S/C](#) [S-2-J-8.3-G D/C](#)